



# Fosse Green Energy

EN010154

## 7.18 Framework Construction Traffic Management Plan (Tracked)

---

VOLUME

7

---

---

Planning Act 2008 (as amended)

Regulation 5(2)(q)

Infrastructure Planning (Applications: Prescribed  
Forms and Procedure) Regulations 2009 (as  
amended)

12 May 2026

---

## Planning Act 2008

### The Infrastructure Planning (Applications: Prescribed Forms and Procedure) Regulations 2009 (as amended)

Fosse Green Energy  
Development Consent Order 202[ ]

---

#### 7.18 Framework Construction Traffic Management Plan

---

Regulation Reference	Regulation 5(2)(q)
Planning Inspectorate Scheme Reference	EN010154
Application Document Reference	EN010154/APP/7.18
Author	Fosse Green Energy Limited

Version	Date	Issue Purpose
Rev 1	18 July 2025	DCO Submission
Rev 2	02 September 2025	Procedural Decision
Rev 2	20 January 2026	Deadline 1 (Rev 2 resubmitted to fix a rendering issue)
Rev 3	06 February 2026	Deadline 2
Rev 4	20 March 2026	Deadline 3
Rev 5	12 May 2026	Deadline 5A

## Table of Contents

1.	Introduction .....	1
1.1	Proposed Development Description .....	1
1.2	Context .....	1
1.3	Document Purpose and Scope .....	2
1.4	Objectives .....	2
1.5	Report Structure .....	3
2.	Existing Conditions .....	5
3.	Future Highway Network .....	6
4.	Policy and Best Practice .....	7
5.	Construction Site Access and Movements .....	8
5.1	Introduction .....	8
5.2	Proposed Site Accesses .....	8
5.3	Construction Programme .....	10
5.4	Construction Vehicle Movements .....	10
5.5	Vehicle Types .....	16
5.6	Plant Requirements .....	17
5.7	Abnormal Vehicles .....	17
6.	Routing and Site Compound Information .....	19
6.1	Introduction .....	19
6.2	Principal Site .....	19
6.3	Cable Corridor .....	22
7.	Management and Mitigation .....	25
7.1	Introduction .....	25
7.2	Pedestrian and Cycle Routes .....	26
7.3	Management Measures and Controls .....	27
7.4	Staff Vehicle Measures and Controls .....	31
7.5	Management Structure .....	34
7.6	Monitoring and Review .....	35
8.	Compliance and Enforcement .....	37
8.1	Introduction .....	37
8.2	Best Practice .....	37
8.3	Contractual Conditions .....	37
8.4	Information Packs and Communications .....	37
8.5	Enforcement .....	38
9.	Conclusion .....	39
	Annex A Access Design Information Table .....	40
	Annex B Proposed Site Access Layouts, Visibility Splays and Swept Paths (Principal Site and Cable Corridor) .....	41



Annex C Indicative Abnormal Vehicle Route Access Swept Paths and Routing (Principal Site).....	42
--	----

## Tables

Table 1: Construction Accesses in each Zone .....	10
Table 2: Forecast Peak Daily Construction Vehicle Movements for the Site .....	12
Table 3: Forecast Peak Daily and Hourly Construction Movement for the Principal Site .....	13
Table 4: Forecast Peak Daily and Hourly Construction Movements for the Cable Corridor .....	15
Table 5: Visibility Splay Requirements.....	20
Table 6: Principal Site Staff Parking Spaces .....	31

# 1. Introduction

## 1.1 Proposed Development Description

- 1.1.1 Fosse Green Energy ('the Proposed Development') will comprise the construction, operation including maintenance, and decommissioning of a solar photovoltaic (PV) electricity generating facility, including on-site Battery Energy Storage System (BESS) and other associated infrastructure, with a total capacity exceeding 50 megawatts (MW), along with an import and export connection to the national transmission network at the proposed National Grid substation near Navenby.
- 1.1.2 The Proposed Development is located approximately 9km to the south and southwest of Lincoln City Centre, in proximity to the villages of Thorpe on the Hill, Witham St Hughs, Haddington, Thurlby, Navenby, and Bassingham.
- 1.1.3 The Proposed Development comprises two distinct parcels of land, collectively defined as the 'DCO Site', specifically:
- the 'Principal Site', which in turn includes the 'Solar PV Array Areas', 'Interconnecting Cable Corridors' and on-site BESS, comprising approximately 1,070 hectares (ha) of land; and
  - the 'Cable Corridor', which is approximately 10km in length and will comprise the underground electrical infrastructure required to connect the Principal Site to the proposed National Grid substation near Navenby. The Cable Corridor partly overlaps with the Principal Site and is approximately 351ha in size.
- 1.1.4 A full description of the Proposed Development is included in **Chapter 3: The Proposed Development** of the ES [EN010154/APP/6.1]. An overview of the Proposed Development and its environmental impacts is provided in the **Non-technical Summary** [EN010154/APP/6.4].

## 1.2 Context

- 1.2.1 AECOM has been appointed by Fosse Green Energy Limited (hereafter referred to as 'the Applicant') to prepare a combined Framework Construction Traffic Management Plan (CTMP) and Travel Plan in support of the Proposed Development. This Framework CTMP forms part of the Development Consent Order (DCO) submission.
- 1.2.2 The Proposed Development, within the administrative area of Lincolnshire County Council (LCC), primarily comprises agricultural fields mainly under arable production, with some small parcels of pasture, interspersed with trees, hedgerows, small areas of woodland and farm access tracks.

## 1.3 Document Purpose and Scope

- 1.3.1 This Framework CTMP supports **Chapter 13: Traffic and Transport** of the ES [EN010154/APP/6.1] which is submitted with the DCO application. The draft DCO [EN010154/APP/3.1] includes a requirement for the Framework CTMP to be developed into a detailed CTMP that would be submitted for the approval of the relevant authorities before construction commences. The DCO would, therefore, include a Requirement to secure compliance with the measures set out in the detailed CTMP.
- 1.3.2 This Framework CTMP sets out the principles that will be adhered to in the detailed CTMP, which will continue to be developed as the detail of the Proposed Development is further progressed. The detailed CTMP will be produced prior to the commencement of construction and will be secured as part of the DCO post-consent. Prior to any construction works being undertaken within the limits of highway adoption, the detailed design of these works must be submitted to LCC for approval.
- 1.3.3 This document sets out the Applicant's proposals to manage construction traffic and staff vehicles within the vicinity of the Proposed Development along the local highway network during the peak construction period of the works, in order to limit any potential disruptions and implications on the wider transport network. It identifies the management of freight, construction traffic i.e. Heavy Goods Vehicles (HGVs), Light Goods Vehicles (LGVs) as well as staff (construction worker) trips.
- 1.3.4 This Framework CTMP has been informed by consultation with LCC as the local highway authority and National Highways (NH) who manage the Strategic Road Network (SRN), as well as North Kesteven District Council (NKDC). Further details of the discussions and meetings held, as well as meeting minutes etc. are provided as part of the Transport Assessment Note (TAN) which forms **Appendix 13-E: Transport Assessment Note** of the ES [EN010154/APP/6.3]).

## 1.4 Objectives

- 1.4.1 The objectives of this Framework CTMP are to set out the principles for the measures that would be developed in the detailed CTMP to:
- Minimise the volume of Heavy Goods Vehicles (HGVs) and staff vehicles associated with the construction phase as far as reasonably practicable;
  - Maximise the safe and efficient movement of materials and staff required during the construction phase as far as reasonably practicable;
  - Minimise the effect on, and ensure efficient management of, the local Public Rights of Way (PRoW) and Claimed PRoW within the Proposed Development during the construction phase; and
  - Minimise the impacts both for the local community and visitors to the area using the road network as far as reasonably practicable.

## 1.5 Report Structure

1.5.1 Following this introduction, this Framework CTMP is structured as follows:

- a. **Section 2** identifies where details related to the existing conditions are set out within the other documents submitted with the DCO application;
- b. **Section 3** provides details of future baseline conditions during the construction phase;
- c. **Section 4** identifies where relevant planning policy and best practice for the construction phase of the Proposed Development is set out as part of the DCO Application;
- d. **Section 5** provides details of the proposed access for the Principal Site and the Cable Corridor as well as summarising the HGV and staff vehicle movements which are expected to be generated by the Proposed Development across the construction period, including during the peak phase of construction;
- e. **Section 6** sets out the details of the layouts, visibility splays, and swept paths of the proposed accesses for the Principal Site and Cable Corridor, as well as routing arrangements and internal layout considerations including access tracks, compounds, and parking;
- f. **Section 7** provides details of the proposed management and measures to avoid and mitigate potential adverse impacts on the local traffic network during the construction phase;
- g. **Section 8** outlines the mechanisms which will be introduced to support compliance with and enforcement of the CTMP; and
- h. **Section 9** provides the conclusion to the document.

1.5.2 This document is supported by the following ES figures [EN010154/APP/6.2]:

- a. **Figure 3-1: Construction Compound and Access Locations;**
- b. **Figure 3-2A: Indicative Fixed South Facing Layout Plan;**
- c. **Figure 3-2B: Indicative Single Axis Tracker Layout Plan;**
- d. **Figure 13-1: Transport Study Area;**
- e. **Figure 13-4: Heavy Goods Vehicle (HGV) Routing;**
- f. **Figure 13-5: Abnormal Indivisible Load (AIL) Routing; and**
- g. **Figure 13-6: Traffic Construction Zones.**

1.5.3 This document is also supported by the following ES appendices [EN010154/APP/6.3]:

- a. **Appendix 13-A: Traffic and Transport Policy and Legislation [EN010154/APP/6.3];** and
- b. **Appendix 13-E: Transport Assessment Note (TAN) [EN010154/APP/6.3].**

1.5.4 In addition, the following DCO documents have been referenced:

- a. **Streets, Rights of Way and Access Plans [EN010154/APP/2.3];**
- b. **Traffic Regulation Measures Plans [EN010154/APP/2.4];**
- c. **Framework Public Rights of Way Management Plan [EN010154/APP/7.14]; and**
- d. **Framework Construction Environmental Management Plan [EN010154/APP/7.7].**

## 2. Existing Conditions

- 2.1.1 Details of the Proposed Development location as well as the existing conditions in terms of the local highway network, pedestrian and cycle routes and public transport networks (bus and rail) are provided in **Chapter 13: Traffic and Transport** of the ES [EN010154/APP/6.1] and the TAN (**Appendix 13-E: Transport Assessment Note** of the ES [EN010154/APP/6.3]).

## 3. Future Highway Network

- 3.1.1 During the construction phase, there are not expected to be any changes to the surrounding highway network within or in close proximity to the Proposed Development as a result of other projects or the Proposed Development that require consideration.
- 3.1.2 The proposed A46 North Hykeham Relief roundabout and A46 Newark Bypass are anticipated to be constructed in advance of the Proposed Development's peak construction phase year of 2032, and therefore will form part of the future highway network.
- 3.1.3 Based on the available information at the time of writing this report, it is anticipated that the proposed A46 North Hykeham Relief roundabout and the A46 Newark Bypass will be completed by 2028 and therefore form part of the future highway network from 2029 onwards. These network upgrade schemes are not expected to overlap with the proposed construction phase of the Proposed Development which is anticipated to start at its earliest in 2031.
- 3.1.4 The cumulative schemes for consideration have been agreed in consultation with LCC. The cumulative schemes which will potentially align with the anticipated peak construction year of 2032 for the Proposed Development, have been assessed against the study area. The potential interactions of the cumulative schemes with the Proposed Development have been assessed and findings are set out within **Chapter 13: Traffic and Transport** of the ES [EN010154/APP/6.1].

## 4. Policy and Best Practice

- 4.1.1 Details of the legislation and planning policy in relation to the assessment of transport and access are provided in **Appendix 13-A: Traffic and Transport Policy and Legislation** of the ES [EN010154/APP/6.3].

## 5. Construction Site Access and Movements

### 5.1 Introduction

- 5.1.1 This section provides a summary of the proposed construction access points which will serve the Proposed Development as well as forecast HGVs, LGVs, and staff vehicle movements estimated during the peak construction phase of the Proposed Development, based on the proposed construction programme in terms of vehicles, estimated number of movements (peak) and vehicle routing.
- 5.1.2 Further details are provided in the TAN (**Appendix 13-E: Transport Assessment Note** of the ES [EN010154/APP/6.3]). This section provides an overview of the forecast construction movements as background information.

### 5.2 Proposed Site Accesses

- 5.2.1 During the construction phase, the Proposed Development will be served by several proposed Principal Site accesses. The Principal Site will have 13 different access points, and the Cable Corridor will be served by seven access points. The proposed access locations for the Proposed Development are illustrated on **Figure 3-1: Construction Compound and Access Locations** of the ES [EN010154/APP/6.2].

#### Principal Site

- 5.2.2 The proposed construction accesses for the Principal Site are as follows:
- a. Access C-001 (East Access off Fosse Lane);
  - b. Access C-002 (West Access off Fosse Lane);
  - c. Access C-003 (Haddington Lane (North));
  - d. Access C-004 (The Avenue);
  - e. Access C-005 (Stone Lane – Crossover);
  - f. Access C-006 (Haddington Lane (East));
  - g. Access C-007 (Haddington Lane (West));
  - h. Access C-008 (Moor Lane (South));
  - i. Access C-009 (Bassingham Road);
  - j. Access C-010 (West Access off Lincoln Road);
  - k. Access C-011 (Clay Lane North (West));
  - l. Access C-012 (Clay Lane North (East)); and
  - m. Interconnecting Cable Access C-020 (Haddington Lane (North))

- 5.2.3 All construction access points associated with the Principal Site are expected to be permanently in place during the operational phase for the lifetime of the development.
- 5.2.4 In addition, there are expected to be three emergency access points which will also serve the Principal Site, these include; (E-001), Bassingham Road (West) (E-002) and Aubourn Moor (E-003).
- 5.2.5 The locations of the proposed access points offer the following benefits:
- The proposed accesses will provide direct access to the Principal Site from the public highway without crossing any third-party land;
  - The accesses will be located on sections of carriageway where the required visibility splays and Sight Stopping Distances (SSDs) will be achievable in each direction subject to vegetation clearance where necessary within the Principal Site (see below); and
  - The accesses and adjoining roads will be appropriate to accommodate HGVs without a need to widen any parts of the network beyond the DCO Site.
- 5.2.6 The accesses to the Cable Corridor will be temporary, in use only during the construction phase and are expected to be reinstated to their original use during the operational phase.
- 5.2.7 The proposed site layout for the construction phase, as well as the temporary construction compounds and the internal access tracks, are shown in **Figure 3-2A: Indicative Fixed South Facing Layout Plan** and **Figure 3-2B: Indicative Single Axis Tracker Layout Plan** of the ES [EN010154/APP/6.2].
- 5.2.8 Further details relating to the above are shown on the **Streets, Right of Way and Access Plans** [EN010154/APP/2.3].

### Cable Corridor

- 5.2.9 During the construction phase, a series of new accesses will be provided to facilitate works within the Cable Corridor as follows:
- Access C-013 - Fen Lane (access proposed to only be utilised in a situation where the haul road running from the BESS access (C-009) is compromised and therefore there is no other alternative access to C-013 Cable Corridor compound);
  - Access C-014 - Broughton Lane;
  - Access C-015 - Hill Rise;
  - Access C-016 - Rose Cottage Lane West;
  - Access C-017 - Rose Cottage Lane East;
  - Access C-018 - Green Man Road (northern access); and
  - Access C-019 - Green Man Road (southern access)

5.2.10 The proposed vehicle access arrangements for the Cable Corridor are shown on **Figure 13-4: Heavy Goods Vehicle (HGV) Routing** of the ES [EN010154/APP/6.2].

## 5.3 Construction Programme

5.3.1 Subject to being granted development consent, construction of the Proposed Development is anticipated to start in 2031 to enable completion for the agreed connection date of 2033. The construction peak in terms of activity and vehicle movements is expected to take place in 2032. The approach taken offers a reasonable worst-case assessment, as it is based on a relatively short construction period (24 months) that would generate the highest number of peak hour and daily road trips on the local network.

## 5.4 Construction Vehicle Movements

### Proposed Development distribution

5.4.1 As set out in a meeting held with the Local Highways Authority (LHA), on 7 March 2025, this methodology for the distribution of construction vehicle trips has been updated to consider a phased construction approach in which the Principal Site will be split into four separate geographical ‘zones’, each containing approximately 20-30% of the Solar PV array area which will be built out in consecutive six-to-eight-month blocks. This presents a more robust scenario of the Proposed Development build out during the peak of the construction phase as construction vehicle trips associated with the peak construction phase have been allocated to each of the four zones to consider and assess variations in vehicle routing throughout the construction period.

5.4.2 The four separate zones are defined as follows, and are shown in **Figure 13-6: Traffic Construction Zones** of the ES [EN010154/APP/6.2]:

- a. Blue Zone;
- b. Yellow Zone;
- c. Green Zone; and
- d. Purple Zone.

5.4.3 The construction accesses contained within each zone are shown in [Table 1](#).

**Table 1: Construction Accesses in each Zone**

Zone	Construction Accesses
Blue	C-004
Yellow	C-008, C-011, C-012
Green	C-003, C-005, C-006, C-007, C-009, C-010, C-020
Purple	C-001, C-002

5.4.4 The current assumptions related to the construction vehicle movements are as follows:

- a. During each six-to-eight-month period of the construction programme, the majority (80%) of construction vehicle trips associated with the Principal Site (including construction staff movements, LGVs and HGVs) would travel to one specific zone of the Principal Site and would be distributed across the various accesses serving the compounds contained within that specific zone.
- b. After each six-to-eight-month period, these trips would then be redistributed to another of the four zones, until construction associated with the fourth and final zone has been completed.
- c. The remaining minority (20%) of trips associated with the Principal Site construction movements would travel to compound C-009 to supply the BESS (for the centralised BESS option). These movements will remain constant throughout the entire 24-month construction programme and would therefore coincide with construction vehicles travelling to each of the four zones as set out above.
- d. Within the Yellow Zone, HGVs (except for the indivisible loads associated with on-site transformer for C-011, which are considered separately) would not travel to accesses C-011 and C-012 due to the narrow width of Clay Lane which restricts HGV movements. Instead, these HGV trips would travel to access C-008, at which point each individual HGV load would be transferred onto four LGVs for onward transit to accesses C-011 and C-012 (from access C-008). In order to limit the potential impact associated with these additional LGV trips, they have been staggered across the working day (between 09:00 and 17:00) to avoid the development and network peak hours.

5.4.5 At the peak of the construction phase, which will occur for a duration of approximately three months of the six-to-eight-month programme for each zone, the Principal Site will accommodate a daily peak of 600 construction staff associated with the Proposed Development, including 575 construction staff for the Principal Site and 25 construction staff for the Cable Corridor. All staff, including the staff associated with the works along the Cable Corridor, would make their way to the Principal Site at the start and end of the working day. One shuttle service will be utilised to transport construction workers from the Principal Site access C-009 to the relevant Cable Corridor access (and vice-versa) to reduce vehicular trips on the surrounding highway network.

### Principal Site

5.4.6 For the purposes of this assessment and based on the information provided in support of the application, the peak daily number of HGVs, LGVs and construction staff required for the Principal Site are identified below:

- a. 50 HGV deliveries (100 movements per day);
- b. 25 LGV deliveries (50 movements per day); and

- c. 600 construction staff (persons) with the forecast number of staff vehicles identified below.
- 5.4.7 In terms of construction staff vehicles, the following has been included as part of this assessment:
- a. 55% of construction staff (330 persons) to be transferred to/from the Principal Site by shuttle service (each with capacity for 50 staff). Details of external locations where staff will be travelling to and from are provided in paragraph 7.4.14 of this document;
  - b. Circa 45% of construction staff (270 persons) to travel by private vehicle. Assuming an average vehicle occupancy rate of 1.3 staff per vehicle, this would result in 208 staff vehicles (416 daily movements), with 35% of staff as drivers (208) and 10% of staff as passengers (62).
- 5.4.8 In relation to the shuttle bus service provision, if additional demand is identified by the monitoring carried out as part of the detailed CTMP (which will be secured through the DCO) then additional shuttle services will be provided to further reduce the number of construction staff vehicles on the network.
- 5.4.9 Given the locations of the nearest rail and bus services/ stops to the Proposed Development and considering the public transport timetables in relation to the construction staff working hours, there will be limited opportunity for construction staff to travel to the Principal Site by rail or bus.
- 5.4.10 Nevertheless, sustainable travel will be promoted for usage by construction staff travelling to/ from the Principal Site with further details set out within this document. The above mode share is considered to provide a robust assessment in terms of the number of construction staff vehicles forecast.
- 5.4.11 The forecast distribution of HGVs, LGVs, and construction staff vehicle movements across the DCO Site accesses for the Principal Site and Cable Corridor are presented in [Table 2](#).

**Table 2: Forecast Peak Daily Construction Vehicle Movements for the Site**

Site	HGVs	LGVs	Staff Vehicles	Shuttle Services	Total two-way movements
Principal Site	100	50	416	32	598
Cable Corridor	32	24	0	4	60

- 5.4.12 A daily profile of overall construction movements (arrivals and departures) for the Principal Site is presented in [Table 3](#) based on the anticipated travel patterns of staff, LGVs, and HGVs across the day.

**Table 3: Forecast Peak Daily and Hourly Construction Movement for the Principal Site**

Hour	HGVs and LGVs		Staff Shuttle Arr.	Vehicles Services (inc. Dep.)	Total movements		two-way Total
	Arr.	Dep.			Arr.	Dep.	
06:00-07:00	0	0	0	0	0	0	0
07:00-08:00	0	0	216	8	216	8	224
08:00-09:00	0	0	0	0	0	0	0
09:00-10:00	11	11	0	0	11	11	22
10:00-11:00	9	9	0	0	9	9	18
11:00-12:00	9	9	0	0	9	9	18
12:00-13:00	9	9	0	0	9	9	18
13:00-14:00	9	9	0	0	9	9	18
14:00-15:00	9	9	0	0	9	9	18
15:00-16:00	9	9	0	0	9	9	18
16:00-17:00	10	10	0	0	10	10	20
17:00-18:00	0	0	0	0	0	0	0
18:00-19:00	0	0	8	216	8	216	224
19:00-20:00	0	0	0	0	0	0	0
<b>Total</b>	<b>75</b>	<b>75</b>	<b>224</b>	<b>224</b>	<b>299</b>	<b>299</b>	<b>598</b>

5.4.13 For the purposes of the assessment, **Table 13.21 of Chapter 13: Traffic and Transport** of the ES **[EN010154/APP/6.1]** identifies the zonal trip assignment of HGV and LGV trips (excluding abnormal loads) on the highway network (including the Strategic Road Network (SRN)) associated with the Proposed Development. The distribution of construction vehicles along the A46 is more robust than the 50% east/ 50% west split which was proposed and agreed during scoping discussions with the LHAs, due to the different distributions adopted for each zone resulting in higher proportions being assessed in each direction. Further details on the zonal trip distribution can be found in **Chapter 13: Traffic and Transport** of the ES **[EN010154/APP/6.1]** of the ES.

5.4.14 An HGV routing plan is shown on **Figure 13-4: Heavy Goods Vehicle (HGV) Routing** of the ES **[EN010154/APP/6.2]** of the ES, identifying the key routes which will be used by HGVs and LGVs (including shuttle bus services) to travel to/ from each site access. It should be noted that for the Principal Site, all HGVs will be expected to travel via the A46 for the Principal Site and via the A15 for the Cable Corridor, with the exception of trips associated with C-013. Trips associated with access C-013 would adopt the same routing as for access C-009 (associated with the Principal Site) and then utilise the internal haul road to access the relevant extent of the Cable Corridor. A separate routing plan for abnormal loads is shown on **Figure 13-5: Abnormal**

**Indivisible Load (AIL) Routing** of the ES [EN010154/APP/6.2], and further details on abnormal loads are set out within **Section 6**.

- 5.4.15 To calculate the trip distribution of workers travelling to and from the proposed construction compounds each day, a simple gravity model has been developed based on 2021 Census data (representing the latest information currently available) for residents that work within the construction industry living within a 60-minute catchment area of the Proposed Development. This has then been reviewed against journey to work data from the 2011 Census (in the absence of this information being available from the 2021 Census due to the COVID-19 pandemic), based on workers travelling to the Proposed Development (North Kesteven MSOA 003) as a car driver.
- 5.4.16 Construction traffic associated with the Principal Site has been distributed onto the local highway network to calculate the resultant percentage increases on each link. It should be noted that a separate distribution has been derived for each Proposed Development access point depending on the associated zone and the traffic flow diagram outputs which are held within **Chapter 13: Traffic and Transport** of the ES [EN010154/APP/6.1]) identify the distribution and assignment of construction vehicles to all of the Principal Site accesses. The traffic flow diagrams assess all four zones, the overlapping routing between the access points as well as the BESS (access C-009) and Cable Corridor (access C-009), and the impact based on the highest trips on each part of the network within the study area at any given time to provide a robust assessment of all the impacted receptors.

### Cable Corridor

- 5.4.17 The Cable Corridor will require a maximum of 25 staff per day across the corridor route. One group of 25 construction staff will travel to/ from the Principal Site compound (to/ from access C-009) to the relevant compound along the Cable Corridor. A shuttle bus service will be utilised to transport these construction staff from the Principal Site to the relevant Cable Corridor compound (and vice-versa) to reduce vehicular trips on the surrounding highway network.
- 5.4.18 For the Cable Corridor, there will be a daily peak of 12 LGVs and 16 HGVs in addition to the 25 construction workers. The associated vehicle trips will use various routes to the east of the Principal Site including the A15, Broughton Lane, Grantham Road, B1202 Heath Lane, Green Man Road, Hill Rise, Fen Lane, and Rose Cottage Lane.
- 5.4.19 In view of the minimal levels of vehicle trips to be generated and given that different access points would be utilised than those used to access the Principal Site (except for access C-009), the Cable Corridor is not expected to have a material impact on the surrounding highway network. Nonetheless, these trips have been included as part of the assessment of the Proposed Development to provide a robust assessment.
- 5.4.20 As set out in **Chapter 13: Traffic and Transport** of the ES [EN010154/APP/6.1], the only expected overlap between the trips associated with the Principal Site and Cable Corridor and local highway network will be

associated with access C-009, as this access falls within the boundary of the Principal Site. Vehicles would utilise access C-009 and the internal haul road to access the Cable Corridor construction compound (note access C-013 would only be used to access this part of the Cable Corridor and the relevant compound should the haul road from access C-009 become unavailable).

5.4.21 A daily profile of overall construction movements (arrivals and departures) for the Cable Corridor is presented in [Table 4](#) based on the anticipated travel patterns of staff, LGVs, and HGVs across the day.

**Table 4: Forecast Peak Daily and Hourly Construction Movements for the Cable Corridor**

Hour	HGVs and LGVs		Staff Shuttle Arr.	Vehicles (inc. Services) Dep.	Total movements		two-way Total
	Arr.	Dep.			Arr.	Dep.	
06:00-07:00	0	0	0	0	0	0	0
07:00-08:00	0	0	0	0	0	0	0
08:00-09:00	0	0	1	1	1	1	2
09:00-10:00	4	4	0	0	4	4	8
10:00-11:00	4	4	0	0	4	4	8
11:00-12:00	3	3	0	0	3	3	6
12:00-13:00	3	3	0	0	3	3	6
13:00-14:00	3	3	0	0	3	3	6
14:00-15:00	3	3	0	0	3	3	6
15:00-16:00	4	4	0	0	4	4	8
16:00-17:00	4	4	0	0	4	4	8
17:00-18:00	0	0	1	1	1	1	2
18:00-19:00	0	0	0	0	0	0	0
19:00-20:00	0	0	0	0	0	0	0
<b>Total</b>	<b>28</b>	<b>28</b>	<b>2</b>	<b>2</b>	<b>30</b>	<b>30</b>	<b>60</b>

5.4.22 For the purposes of the assessment, all HGVs and LGVs identified in [Table 4](#) have been assigned across the following parts of the network to access all parts of the Cable Corridor:

- a. A15 Sleaford Road;
- b. B1178 Tower Lane;
- c. B1202 Heath Lane;
- d. Green Man Road;
- e. Broughton Road;
- f. Hill Rise; and
- g. Rose Cottage Lane

- 5.4.23 In terms of construction workers, it is assumed that a single shuttle bus service would transport the 25 construction workers from the Principal Site to the Cable Corridor in the morning and vice-versa in the evening. The same assumptions have been adopted as above in terms of routing the shuttle bus service to all access points.
- 5.4.24 Again, it should be noted that construction workers would travel to/ from the Principal Site at the very start and end of their working day as per the arrangements set out in the earlier section.
- 5.4.25 The HGV routing plan shown in **Figure 13-4: Heavy Goods Vehicle (HGV) Routing** of the ES [EN010154/APP/6.2] identifies the key routes which will be used by HGVs and LGVs to travel to/ from each site access for the Cable Corridor.
- 5.4.26 Construction traffic associated with the Cable Corridor has been distributed onto the local highway network to assess the resultant percentage increases on each receptor. The same peak level of construction vehicle activity has been assessed for each receptor associated with the Cable Corridor to provide a robust assessment based on the highest trips associated with the Proposed Development along each part of the network, assessing the routing to each individual access point along the Cable Corridor. Since the assumed trip distribution within the Cable Corridor is 100% at each receptor, flow diagrams have not been provided.

## 5.5 Vehicle Types

- 5.5.1 It is expected that the majority of construction vehicles accessing the Proposed Development will fall within the standard dimensions and weight limits for road transport size category (i.e. transit vans and HGVs). It is anticipated that the following vehicle types will serve the Proposed Development during the construction phase:
- a. Cars;
  - b. Tractors;
  - c. Small vans;
  - d. 10m rigid vehicles;
  - e. Box vans;
  - f. 8-wheeler rigid lorries;
  - g. Concrete mixers; and
  - h. Articulated lorries (16.5m).
- 5.5.2 In addition, it is expected that there will be several Abnormal Indivisible Loads (AILs)/ abnormal vehicles required by the Proposed Development to assist with the delivery of the transformer to the Principal Site BESS as well as the cable drums along the Cable Corridor. Details of the vehicles required to transport AILs are set out in **Section 5.7**.

## 5.6 Plant Requirements

5.6.1 The typical plant requirements (and associated vehicle types) for the Horizontal Directional Drilling (HDD) during the construction works are listed below:

### Launch Pits

- a. (16.5m) articulated lorry for delivery / pick up of the directional drill rig;
- b. Three articulated lorries for delivery of cable;
- c. Up to 5 x three-axle rigid (13.5m) flatbeds for delivering temporary trackway;
- d. One telehandler anticipated to be delivered on articulated lorry;
- e. One excavator (anticipated to be delivered and picked up with the telehandler);
- f. Two 6m<sup>3</sup> capacity concrete lorries for delivering the concrete to create the joint bays;
- g. Two Vans;
- h. Beavertail Lorry & 1000 Gallon Tank (with 13m x 2.5m Rod boxes);
- i. JT8020 – HDD Rig (9m x 2.6m) and 20t in weight;
- j. John Deere 7280R Tractor and Tanker (12.3m x 2.5m);
- k. Vehicle with 2 x 1000 Gallon Mixing Tanks (9m x 2.5m); and
- l. Mud Mixing Tank Unit (7.6m x 2.5m).

### Reception Pits

- a. Four excavators (anticipated to be delivered and picked up with the telehandler);
- b. Two 6m<sup>3</sup> capacity concrete lorries for delivering the concrete to create the joint bays;
- c. Three articulated lorries for delivery of cable;
- d. Up to 5 x three-axle rigid flatbed for delivering temporary trackway;
- e. One telehandler anticipated to be delivered on articulated lorry; and
- f. One flatbed lorry for the delivery of sand.

5.6.2 The above are expected to be sourced locally and will be delivered to the Proposed Development either driven in larger units and/ or by plant haulage.

## 5.7 Abnormal Vehicles

5.7.1 The following abnormal vehicles are expected during the construction phase of the Proposed Development; further details of these are set out within **Section 6**:

- a. A 46.6m length vehicle to deliver the transformer to the Principal Site via access C-009 on Bassingham Road (arrival only, as the vehicle would be disassembled prior to egress); and
  - b. Several 24.6m length vehicles to transport cable drums to/ from the Cable Corridor via multiple access points (arrivals and departures).
- 5.7.2 A specialised haulage service will be employed to allow these components to be transported with the necessary escort, permits and traffic management, with the Applicant consulting the relevant highways authorities to ensure the correct permits are obtained. The police will also be given advanced notification under the Road Vehicle Authorisation of Special Types Order 2003.
- 5.7.3 The abnormal vehicles will be required to follow the abnormal vehicle routing strategy (**Figure 13-5: Abnormal Indivisible Load (AIL) Routing [EN010154/APP/6.2]**) when travelling to/ from the Site. At this stage, only a preliminary vehicle swept path assessment has been undertaken for the routes to the Principal Site and the Cable Corridor access points to highlight the viability, constraints, and potential pinch points along the set out routes. It has not been possible to carry out an in-depth assessment of the Abnormal Invisibile Loads (AIL) routing as the port of entry (point of origin) is not yet known. Therefore, this will be carried out at a later stage, once the port of entry has been determined, to identify any additional potential constraints along the remainder of the route, once this is known. It should be noted that the assessment of the AIL routing is not expected to change any of the conclusions set out within the **Chapter 13: Traffic and Transport** of the ES **[EN010154/APP/6.1]**. The Proposed Development is not expected to require a significant number of AILs and the peak construction assessment focuses explicitly on the movements of construction worker trips and materials (HGV and LGV).

## 6. Routing and Site Compound Information

### 6.1 Introduction

- 6.1.1 The section outlines the vehicle routing for the Principal Site and Cable Corridor and details relating to the associated construction compounds.

### 6.2 Principal Site

#### Vehicle Routing

- 6.2.1 Construction HGVs will travel to/ from the Principal Site primarily via the A46 and will then utilise the local highway network to reach the access points. The routing strategy reflects the most suitable routes available.
- 6.2.2 A vehicle routing plan showing the routing strategy for HGVs at the Principal Site is shown in **Figure 13-4: Heavy Goods Vehicle (HGV) Routing** of the ES [EN010154/APP/6.2]. It should be noted, the zone where the construction works are being undertaken will determine the routing utilised. Even though there is some overlap in the proposed routing for certain access points of the Principal Site, the routing varies. Signage will form a key part of the Temporary Traffic Management and will ensure that traffic utilises the designated routes. Engagement will take place with NH (and LCC for local roads, as necessary) in developing the signage strategy as part of the detailed CTMP. This will include overall signage strategies for routes, including sign locations and sign face details for approval.

#### Access Layouts

- 6.2.3 The proposed layouts of the accesses to the Principal Site are shown within **Annex B** of this Framework CTMP. Local highway improvements (e.g. verge clearance, hedge cutting and/ or local carriageway realignment) will be carried out at each site access where required and a 6.0m carriageway width will be provided along internal construction routes for HGVs (further details are set out within **Section 7**).
- 6.2.4 The proposed site access roads will be surfaced with a bound surfacing material over a minimum 20m distance from the junction, to minimise the transfer of material onto the public highway by construction vehicles.
- 6.2.5 The DCO Site access roads have been designed to accommodate two-way HGV movements irrespective of the level of activity, where there are any pinch points, passing places have been designed to accommodate the two-way movements of vehicles in narrow places. The access roads have been designed to accommodate the appropriate level of activity without resulting in any vehicles backing up and blocking the local highway network in the vicinity of the access.

## Visibility Splays

- 6.2.6 The Design Manual for Roads and Bridges (DMRB) CD 109 (Highway Link Design) identifies desirable minimum SSDs based on the design speed of the carriageway. These values are adopted within DMRB CD 123 (Geometric design of at-grade priority and signal-controlled junctions) in order to determine the visibility requirements (the ‘y’ distance) at priority junctions, measured along the edge of the major road carriageway from the centreline of the minor arm at the junction. These requirements are shown in [Table 5Table 5](#) below.

**Table 5: Visibility Splay Requirements**

Design Speed	SSD (‘Y’ Distance)
50	70m
60	90m
70	120m
85	160m
100	215m
120	295m

- 6.2.7 The minimum distance from which the visibility splays are measured at simple priority junctions is at a 2.4m setback (the ‘x’ distance) from the give-way line.
- 6.2.8 The ‘Desirable Minimum’ SSDs in the DMRB are based on a driver perception/ reaction time of two seconds and a deceleration rate of 0.25g (2.45 m/s<sup>2</sup>). The ‘Absolute Minimum’ (one step below Desirable Minimum) SSD values use the same reaction time and a deceleration rate of 0.375g (3.68 m/s<sup>2</sup>).
- 6.2.9 The 85<sup>th</sup> percentile speed of traffic represents the appropriate speed measurement for an existing major road when determining visibility splay requirements. The above parameters have been adopted to calculate the desirable minimum and absolute minimum visibility requirements for all roads with proposed accesses based on the highest recorded 85<sup>th</sup> percentile speeds from the surveys carried out in November 2023 and February 2025, as identified within **Chapter 13: Traffic and Transport** of the ES **[EN010154/APP/6.1]**. The results are shown in **Annex A**.

## Abnormal Vehicles

- 6.2.10 A detailed assessment of the abnormal vehicles required for the Principal Site and/or the Cable Corridor will be carried out post consent once an appropriate haulage company has been identified and the specific dimensions of the AIL are known. The haulage company will assess the movement associated with the delivery of a transformer as well as cable drums once the point of entry has been confirmed (this will most likely be Immingham Port, however this is not confirmed at this current stage). The nature of the delivery is such that an AIL will only be required when the transformer is transported to the Principal

Site, as the vehicle will be disassembled and take the form of a standard vehicle prior to its departure, a preliminary assessment of this has been undertaken, reviewing the routing from the A46 to construction access C-009, in order to test the viability of this routing, presented in **Annex C**. Similarly, an assessment of the routing for the cable drums from the A15 was undertaken to highlight any potential constraints and pinch points along the route.

### Vehicle Swept Paths

- 6.2.11 As set out above, the proposed routing strategy for HGVs (non-abnormal vehicles) is via the A46 and A15 and then the local highway network to reach the access points for the Principal Site and Cable Corridor. The location of accesses and proposed routes will ensure that larger vehicles take the most direct route to and from the Site, while minimising the number of turning movements. Drawings showing vehicle swept paths for a 16.5m maximum legal articulated vehicle are presented in **Annex B**.
- 6.2.12 The vehicle swept paths demonstrate that construction vehicles will be able to turn in/ out of the proposed site accesses without overrunning any kerb lines. It should be noted that banksmen will be in place to control HGV movements at the accesses to ensure these movements are carried out safely. An appropriate level of visibility will be achievable to/ from the accesses as set out above. No carriageway widening or amendments will be required outside of the DCO Site.

### Construction Compounds

- 6.2.13 As shown by the proposed construction compound and access location plan (**Figure 3-1: Construction Compound and Access Locations** of the ES [EN010154/APP/6.2]), there are expected to be six temporary construction compounds within the Principal Site at strategic locations, all served by the primary and secondary access routes. The compounds are expected to be converted to solar PV at the end of their use in the operational phase.
- 6.2.14 The compounds will contain offices, a mobile welfare unit, canteen, storage and waste skips, a power supply, parking areas and space for storage, a wheel washing facility, a bunded area for refuelling and the storage of liquids, as well as unloading and turning areas. It is expected that there will be least one compound to serve each construction zone, in addition there will be some supplementary smaller compounds.
- 6.2.15 The smaller secondary construction compounds will be situated across the Principal Site at strategic locations. The secondary compounds are expected to include material storage areas, a mobile welfare unit, office, diesel generators, rock fill placed on a suitable formation and temporary matting (if required), fencing to secure the compound, parking areas, and turning areas.

### Access Tracks

- 6.2.16 It is proposed to utilise the existing hard-surfaced tracks that run throughout the Principal Site where possible (upgrading existing access tracks through widening or resurfacing where these are required along the route), and to

construct additional access tracks where connectivity is required. The internal tracks will enable free-flowing movement within the DCO Site whilst removing construction traffic movements from local roads.

### Car and Cycle Parking

- 6.2.17 During the construction phase of the works, a maximum of 225 car parking spaces will be provided across the four zones of the Principal Site, dependent on where the works are based, to meet peak parking demand. Construction workers will then be transported around the Proposed Development via shuttle buses (if required). The usage of the car parks will be monitored and the potential to introduce additional parking will be explored during peak construction if required, to ensure that parking does not occur anywhere outside of the Principal Site.
- 6.2.18 A total of 15 cycle parking spaces will also be provided within the construction compounds of the Principal Site, to accommodate any trips made to the Principal Site via sustainable modes of travel.

## 6.3 Cable Corridor

### Vehicle Routing

- 6.3.1 The Cable Corridor will be accessed via a range of accesses along the corridor alignment. The accesses will be in place during the construction phase and retained thereafter (controlled by gates) to facilitate maintenance and repairs as necessary during the operational phase. The proposed HGV routing strategy to/ from the Cable Corridor is identified on **Figure 13-4: Heavy Goods Vehicle Routing** of the ES [EN010154/APP/6.2].

### Access Layouts

- 6.3.2 The proposed layouts of the accesses are shown within **Annex B**. This shows that the construction access roads will be 6m wide to accommodate two-way HGVs (excluding abnormal loads) including the required load bearing capacity, load overhang and turning provisions as shown by the vehicle swept paths (covered further below). The Cable Corridor accesses are expected to serve up to 16 HGVs and 12 LGVs per day during the peak construction period and the design of the accesses will sufficiently accommodate this.

### Visibility Splays

- 6.3.3 Visibility splays in accordance with [Table 5](#) will be provided at all accesses commensurate with the desirable minimum requirement for the relevant 85<sup>th</sup> percentile speed at each adjoining link.
- 6.3.4 The same parameters have been adopted as for the Principal Site to calculate the desirable minimum and absolute minimum visibility requirements for Cable Corridor accesses, the results are shown in **Annex A**.
- 6.3.5 Drawings showing the required areas to be kept clear to achieve the required visibility splays are shown within **Annex B**. These drawings demonstrate that

the desirable minimum visibility splays (identified in **Annex A**) can be achieved through the clearance of vegetation etc. within the highway boundary and/ or the land included within the DCO Site.

### Abnormal Vehicles

- 6.3.6 The abnormal vehicles relating to the Cable Corridor will be associated with the delivery of the cable drums. A summary of the assessment of abnormal vehicles for the Cable Corridor is as follows:
- a. Swept path analysis has been undertaken based on a 16.5m articulated vehicle – additionally, pinch-point areas along the AIL route have been reviewed to assess the suitability of the route to accommodate the cable drums
  - b. Swept path analysis will be carried out post consent using a vehicle at overall 24.6m length and 2.85m width, transporting a cable drum which will be 4.7m in width and 4.47m in height to check if additional accesses are sufficient to receive the cable drums;
  - c. Vehicles will travel to/ from the A15 to the east and then travel via the designated routes set out within the AIL figure, adopting the same routes as the HGVs for the Cable Corridor access points (**Figure 13-5: Abnormal Indivisible Load Routing** of the ES [EN010154/APP/6.2]);
  - d. Traffic Management and temporary localised closures/ diversions of affected footways will be implemented where necessary to facilitate turning manoeuvres at junctions. Any damage to existing pavement infrastructure such as kerblines or tactile paving would subsequently be reinstated to the satisfaction of the LHA; and
  - e. Vegetation clearance will be undertaken and passing places provided where necessary to accommodate construction vehicles (including abnormal vehicles) travelling to/ from the Cable Corridor.
- 6.3.7 The above improvements will be carried out within the DCO Site and the movements will take place subject to the management measures outlined in **Section 7**.

### Vehicle Swept Paths

- 6.3.8 For construction accesses within the Principal Site and Cable Corridor, swept paths have been carried out for 16.5m maximum legal articulated vehicles.
- 6.3.9 The swept paths (**Annex B**) demonstrate that all construction vehicles will be able to access the Proposed Development without overrunning any kerb lines, noting that HGVs will not be utilising accesses C-011 and C-012 (with the exception of 28 indivisible loads in the form of HGVs which will be required to deliver transformers to access C-011; these will use Moor Lane and Bassingham Road to Clay Lane and then use Clay Lane to access C-011). It should be noted that banksmen will be in place to control HGV movements at the accesses to ensure these movements are carried out safely. An appropriate level of visibility will be achievable to/from each access as set out above. Traffic management will be employed as necessary along the section

of Clay Lane leading to access C-011 to manage the 28 indivisible loads which will be required to travel to this access.

## Construction Compounds

- 6.3.10 Construction compounds will be located at specified positions within the Cable Corridor, accessed via the nearest access point to that compound. Construction workers will travel by shuttle bus service from the Principal Site in order to access the compounds within the Cable Corridor. The proposed indicative locations of the Cable Corridor construction compounds are shown on **Figure 3.1: Construction Compound and Access Locations** of the ES [EN010154/APP/6.2]. The construction compounds associated with the Cable Corridor will likely be situated at strategic locations along the Cable Corridor and will be similarly provisioned to the smaller secondary compounds of the Principal Site set out within paragraph 6.2.15.

## Car Parking

- 6.3.11 No car parking spaces will be provided for construction workers within the construction compounds serving the Cable Corridor, as staff will be transferred to and from this portion of the DCO Site via a shuttle bus service. All construction workers associated with working along the Cable Corridor will park within the construction compounds associated with the Principal Site access C-009.

## Plant Requirements

- 6.3.12 A wide range of vehicle types will be used to meet the requirements for the delivery of plant to the site. Aside from the items identified as AILs for the Cable Corridor (cable drums) these will be accommodated by the proposed access routes identified previously.

## 7. Management and Mitigation

### 7.1 Introduction

7.1.1 This section of the Framework CTMP outlines the construction traffic management measures that will be implemented in support of the Proposed Development, to avoid any adverse impacts on the surrounding networks during the construction phase.

#### Highway Improvements

7.1.2 The following highway improvements will be required to accommodate construction vehicles travelling to/ from the Proposed Development:

- a. Potential temporary traffic management/ footway closures to accommodate the abnormal vehicle transporting the AIL (transformer) to the Principal Site (Access C-009 from the A46) as well as abnormal vehicles transporting AILs (cable drums) both to and from the Cable Corridor (see **Figure 13-5: Abnormal Indivisible Load Routing** of the ES [EN010154/APP/6.2]);
- b. Vegetation clearance to accommodate construction vehicles (including abnormal vehicles) travelling to/ from the Proposed Development (see **Annex A** for specific access details); and
- c. Temporary speed limit to be introduced on section of Basingham Road (40mph) to facilitate works associated with the construction phase; and
- d. Signage will form a key part of the Temporary Traffic Management and will ensure that traffic utilises the designated routes. This will include overall signage strategies for routes, including sign locations and sign face details.

7.1.3 The DCO Site includes the areas required to accommodate the above improvements where required. The works within carriageways will be agreed with the LHA post consent once the precise sizing of the vehicles is known. Prior to any construction works being undertaken within the limits of highway adoption, the detailed design of these works must be submitted to LCC for approval. These submissions will include:

- a. A programme for the works, details of the construction method and traffic management requirements;
- b. A detailed design pack of drawings and specifications detailing the works and any service / utility works that may need to be accommodated;
- c. The necessary health and safety information required under the Construction, (Design & Maintenance) Regulations, or their equivalent at the point of submission;
- d. Details of the proposed contractor, including their insurance provisions;
- e. If required by the local road authorities, a Road Safety Audit (RSA) to a combined Stage 1 and Stage 2 standard;

- f. Details of any necessary road signage and road markings; and
- g. Details of any proposed remediation proposals should the works not be permanent.

The detailed CTMP will detail the exact process for these technical approvals.

### Localised Traffic Management Measures

- 7.1.4 Temporary Traffic Management (TTM) measures are likely to be required to accommodate the construction of each of the access points. Furthermore, TTM will be required along Broughton Lane, A607 Grantham Road, B1202 Heath Lane and Green Man Road to accommodate the installation of the cables in the instance that open-cut trenches method is employed over trenchless HDD.
- 7.1.5 It should be noted that trenchless methods will be utilised when installing the cable beneath the A46 to avoid any lane or road closures along the Strategic Road Network. Further details will be provided as part of the detailed CTMP to be submitted to the Local Authority post consent.

### Stage 1 Road Safety Audit

- 7.1.6 A Stage 1 Road Safety Audit (RSA) will be carried out for the following aspects, post-consent:
  - a. The DCO Site access points and crossovers for the Proposed Development; and
  - b. Highway improvements as identified above.
  - c. Any temporary traffic management measures on the Strategic Road Network (SRN) that are in place for longer than six months (in line with DMRB GG 119).
- 7.1.7 The highway improvements will be secured by the DCO, and further details of the works required to deliver the improvements will be provided in the detailed CTMP.

## 7.2 Pedestrian and Cycle Routes

- 7.2.1 Access to all existing PRow will be retained during the construction phase, with a limited number of temporary and permanent PRow diversions/closures around the Cable Corridor works areas when the cabling is installed or to physically separate these from the proposed construction routes as well as temporary diversions/closures within the Principal Site.
- 7.2.2 Further details of the anticipated interactions between construction works/routes and how the existing PRow will be managed during the construction phase (as well as operation and decommissioning) are set out within the **Framework PRow Management Plan [EN010154/APP/7.14]**.

## 7.3 Management Measures and Controls

### Introduction

- 7.3.1 The following measures will be implemented to manage HGV deliveries to the Proposed Development (relating to both the Principal Site and the Cable Corridor) and further details are set out under separate headings below:
- a. Road condition surveys;
  - b. Delivery management system;
  - c. Traffic management and monitoring;
  - d. Suitable HGV routes – avoiding any unsuitable routes, such as Clay Lane and Fen Lane;
  - e. HGV timing restrictions;
  - f. Banksmen and site management;
  - g. Communications strategy;
  - h. Appropriate site access arrangements;
  - i. Necessary escort, permits and traffic management for AILs; and
  - j. Interactions with pedestrians and cyclists.

### Road Condition Surveys

- 7.3.2 A road condition survey will be carried out pre-construction, during construction and post-construction, to identify any defects that arise to highways assets/ verges during the construction phase of the Proposed Development for re-instatement. Any defects that arise to highways assets/verges during the construction phase due to the Proposed Development (as identified through the road condition surveys) will be reinstated/made good [by the Applicant](#). At this stage, it is proposed to carry out a road condition survey at the following locations within the DCO Site (see the study area shown on **Figure 13-1: Transport Study Area** of the ES [EN010154/APP/6.2] for reference):
- a. Fosse Lane, covering the DCO Site in the vicinity of the proposed access point;
  - b. The Avenue, covering the DCO Site in the vicinity of the proposed access point;
  - c. Haddington Lane, covering the DCO Site associated with the four proposed access points;
  - d. Stone Lane, covering the DCO Site in the vicinity of the proposed access point;
  - e. Moor Lane, covering the DCO Site in the vicinity of the proposed access point;

- f. Clay Lane, covering the DCO Site associated with the two proposed access points;
  - g. Fen Lane, covering the DCO Site in the vicinity of the proposed access point;
  - h. Bassingham Lane, covering the DCO Site associated with the two proposed access points;
  - i. Broughton Lane, covering the DCO Site in the vicinity of the proposed access point;
  - j. Hill Rise, covering the DCO Site in the vicinity of the proposed access point;
  - k. High Dike, covering the DCO Site associated with the two proposed access points; and,
  - l. Green Man Road, covering the DCO Site associated with the two proposed access points.
- 7.3.3 Road condition surveys should only be needed on roads directly serving the access points, to be used by HGVs or abnormal vehicles in the construction phase of the works, they are not expected to be required for any roads which will serve the operational or emergency access point in the operational/ maintenance phase.
- 7.3.4 In addition, a separate road condition survey will be carried out for the abnormal vehicle routes (transformer and cable drums) to the Principal Site, covering the route between the A46 junction and the proposed site access on Bassingham Road (C-009) i.e. via Haddington Lane. This will be used to identify any defects that arise to highways assets/ verges as a result of these abnormal loads for re-instatement. As above, this survey would be carried out both before and after any abnormal loads travel on the network.

### Delivery Management System

- 7.3.5 A Delivery Management System (DMS) will be implemented to control bookings of HGV deliveries from the start of the construction period. This will be used to regulate the arrival times of HGVs via timed delivery slots, as well as to monitor compliance of HGV routing which will be communicated to all suppliers. In addition, measures will be in place to ensure no queuing back from accesses onto the surrounding road network occurs.

### Traffic Management and Monitoring

- 7.3.6 A Traffic Management and Monitoring System (TMMS) will be developed to provide details of the technologies and other means employed to monitor HGV movements to/ from the DCO Site e.g. Global Positioning System (GPS) and Automatic Number Plate Recognition (ANPR). This will enable the Applicant to monitor the following:
- a. Compliance with the HGV routes;
  - b. Compliance with the number of HGV limits in terms of number of deliveries arriving and departing at any one time and over the course of the day; and

c. Compliance with the timing restrictions.

7.3.7 In addition, the TMMS will also record all LGVs which enter and exit the Proposed Development, to allow all vehicles to be monitored. In the instance that a complaint has been made in relation to inappropriate routes being used, then this will be cross-referenced with the TMMS to allow appropriate actions to then be taken.

7.3.8 The precise form of TMMS would be determined following the appointment of a contractor and will include a summary of the contractual requirements which those visiting the Proposed Development will have to adhere to, along with the measures to be taken for non-compliance.

### HGV Routes

7.3.9 HGVs will be required to comply with the proposed routing strategy (**Figure 13-4: Heavy Goods Vehicle Routing** of the ES [EN010154/APP/6.2]) in accordance with the DMS and TMMS. The following strategies will be applied:

- a. Routing strategy for HGVs (excluding abnormal vehicles) for the Principal Site. It should be noted that each construction access point will have a specific route to follow. HGV trips associated with C-011 and C-012 will be diverted to access C-008, at which point the material will be transferred over to the relevant parcel via a smaller sized vehicle (except for 28 HGV deliveries of indivisible loads required to travel to access C-011 for the on-site transformers); and
- b. Routing strategy for HGVs (including abnormal vehicles) for the Cable Corridor.

7.3.10 In the case of exceptional circumstances where the proposed routing to the Proposed Development is compromised due to an incident or road closure for example, then it is considered acceptable for HGVs to be redirected via an alternative route or to deliver outside of the established scheduling if required.

7.3.11 It should be noted that a 7.5 ton Weight Restriction in place on Fosse Lane Northbound (heading towards Thorpe on the Hill) at the junction between Haddington Lane and Fosse Lane will be enforced, with construction vehicles only utilising a short distance of Fosse Lane northbound towards access C-002.

### HGV Timing Restrictions

7.3.12 To reduce the potential impact of HGV deliveries, the arrival and departure times will be managed to minimise the number of HGVs travelling to the Proposed Development during the network peak hours for the local highway network; identified within the ES (**Chapter 13: Traffic and Transport** of the ES [EN010154/APP/6.1]) as 08:00-09:00 and 17:00-18:00. For example, HGVs could be delayed in the afternoon to avoid being released from the DCO Site during the PM network peak hour.

7.3.13 The timing restrictions, considered likely to be implemented at this stage are:

- a. Avoiding arrivals or departures on a weekday between 08:00-09:00 and 17:00-18:00;
  - b. No arrivals or departures on a Saturday before 08:00 or after 13:00; and
  - c. No arrivals or departures on Sundays or public holidays.
- 7.3.14 The restrictions imposed on deliveries by HGVs will be set out within the DMS and TMMS.

### Banksmen and Site Management

- 7.3.15 Suitably qualified banksmen will be positioned at the proposed site accesses for the Principal Site, and at the proposed site accesses for the Cable Corridor, and at internal crossing points when required, to allow vehicle arrivals and departures, as well as internal vehicle movements to be safely controlled during the construction period. This includes the network of internal access routes and the PRoW crossing points within the Proposed Development.

### Communications Strategy

- 7.3.16 A Communications Strategy will be developed by the Applicant post-consent to ensure that the measures contained within the detailed CTMP are communicated to the workforce. This would include an information pack setting out the contractual requirements which will be provided to the Applicants. Furthermore, regular meetings will be held with contractors to discuss HGV management and to address any issues associated with travel to / from the Proposed Development as well as to relay information including any restrictions and requirements which should be followed.

### Proposed Development Access Arrangements

- 7.3.17 The Proposed Development access layouts have been designed to accommodate HGVs as shown by the vehicle swept paths held in **Annex B**. A hardstanding surface will be provided at the proposed accesses to ensure the weight of the HGVs can be accommodated. In addition, wheel washing facilities will be provided at every construction access to minimise mud from being trafficked onto the highway.
- 7.3.18 Vegetation and hedgerow clearance will be carried out at the proposed site accesses, where required to achieve appropriate levels of visibility, subject to agreement with the LHA. Details related to the specific visibility splays and the vegetation clearance requirements for each specific access are set out in **Annex A**, which have been agreed with the LHA as part of ongoing discussions.

### Abnormal Vehicles

- 7.3.19 As set out previously, a specialised haulage service will be appointed to allow ALLs to be transported, with the necessary escort, permits and traffic management in place. The Applicant will consult with the relevant highways authorities to ensure the correct permits are obtained. The police will also be

given advanced notification under the Road Vehicle Authorisation of Special Types Order 2003.

## Pedestrians and Cyclists

7.3.20 The **Framework PRow-MP [EN010154/APP/7.14]** sets out the measures which have been included as embedded mitigation within the ES **[EN010154/APP/6.1]** to minimise the traffic impacts of the Proposed Development on pedestrians and cyclists during the construction and decommissioning phases.

7.3.21 It should be noted that all pedestrian and cycle routes will be maintained and remain unobstructed at all times when in use, to ensure the continued safe passage of the public including when using the PRow through the DCO Site and at crossing points. The measures will be secured through the DCO, primarily by this document, as well as via the **Framework Construction Environmental Management Plan [EN010154/APP/7.7]**.

## 7.4 Staff Vehicle Measures and Controls

7.4.1 Staff movements will be managed through the implementation of the following measures:

- a. Limited car parking;
- b. Car sharing;
- c. Staff arrival and departure times; and
- d. Shuttle service providing transport between local settlements and the Principal Site, and between the Principal Site and the Cable Corridor.

### Limited Car Parking

7.4.2 The proposed car parking facilities for the Principal Site will be situated within the construction compounds of each of the four zones. The total capacity of the car parks is set to be limited up to a maximum of 225 spaces allocated to construction staff, to accommodate (but limit) the expected parking demand of construction staff within the Principal Site during the peak construction period, with additional parking available for shuttle buses, LGVs and HGVs (if deemed required). The usage of the car park will be monitored and the potential to introduce additional parking will be explored during peak construction if required.

7.4.3 A breakdown of where these parking spaces will be located during each zonal construction phase is shown in [Table 6](#).

**Table 6: Principal Site Staff Parking Spaces**

Site Access	Yellow Parking	Zone	Blue parking	Zone	Green Parking	Zone	Purple Parking	Zone
C-001	0		0		0		0	
C-002	0		0		0		175	

C-003	0	0	50	0
C-004	0	175	0	0
C-005	0	0	25	0
C-006	0	0	25	0
C-007	0	0	40	0
C-008	85	0	0	0
C-009	50	50	50	50
C-010	0	0	25	0
C-011	45	0	0	0
C-012	45	0	0	0
C-020	0	0	10	0
<b>Total*</b>	<b>225</b>	<b>225</b>	<b>225</b>	<b>225</b>

7.4.4 No staff car parking spaces will be provided for construction workers within the construction compounds serving the Cable Corridor, as staff will be transferred to and from this part of the Proposed Development via shuttle buses after utilising the car parks within the Principal Site (C-009) construction compounds.

### Car Sharing

7.4.5 To reduce the potential impact of vehicles associated with the local staff during the construction period, the Applicant will implement measures to encourage car sharing to reduce the number of vehicles travelling to/ from the Proposed Development each day. The benefits of car sharing will be promoted to encourage multi-occupancy vehicle use, such as reduced fuel costs and ease of parking with guaranteed spaces for those car-sharing within the compounds.

7.4.6 A Car Share scheme will be implemented to match potential sharers and to help staff identify any colleagues who could potentially be collected along their route to/ from the Proposed Development. The limited car parking and the use of the shuttle service will encourage staff to travel together.

7.4.7 For the Principal Site, a robust minimum occupancy rate of 1.3 persons per vehicle for local staff (an assumption adopted within **Chapter 13: Traffic and Transport** of the ES [EN010154/APP/6.1]) is expected; however, the aspiration is to achieve a higher average occupancy level to further reduce the impact of the development on the local network and the SRN. The occupancy rate has been based on a similar consented DCO Solar Site in Lincolnshire and the approach and methodology was agreed with LCC and NH during a meeting held on the 7 March 2025.

7.4.8 The staffing requirement and occupancy for the Cable Corridor is inclusive within the overall site, given that staff will be transferred to/ from the Cable

Corridor by shuttle bus service from the designated Principal Site access (C-009).

## Staff Arrivals and Departures

- 7.4.9 The proposed working hours of staff are set out below.
- 12-hour shift (07:00-19:00) Monday to Friday; and,
  - 6-hour shift (07:00-13:00) on Saturday.
- 7.4.10 The network peak hours for the local highway network are 08:00-09:00 and 17:00-18:00 (see the **Appendix 13-D: Receptor Traffic Flow Tables** of the ES [EN010154/APP/6.3]) for further details). Construction workers will be expected to arrive in the hour before the start of their shift and to depart in the hour after the end of their shift. Based on the above, all staff are expected to avoid the network peak hours. The proposed working hours are therefore designed to minimise additional trips at the busiest times in terms of trips on the surrounding highway network.
- 7.4.11 Following consultation with LCC Highways, a 'scenario' for staff movements has been used to provide a robust weekday assessment based on the assessment of the 'shoulder' peak as the Proposed Development peak. Accordingly, rather than adopting 06:00-07:00 for staff arrivals and 19:00-20:00 for staff departures, construction worker travel patterns have been based on the 'shoulder' peaks to the traditional network peak hours. Therefore, staff arrivals have been assumed to take place between 07:00-08:00 and staff departures have been assumed to take place between 18:00-19:00 (Monday to Friday).
- 7.4.12 In the instance that any on-site works are conducted outside of the above working hours, then these will comply with any restrictions agreed with the relevant planning/ highway authorities.

## Shuttle Bus Service

### Non-local Staff staying in Nearby Accommodation

- 7.4.13 A shuttle bus service (each with capacity for 50 staff) will be used to transport 55% of construction staff (330 persons) staying within local accommodation at the six main urban centres in the vicinity of the Proposed Development; considered to be within a 60-minute driving distance to/ from the Principal Site.
- 7.4.14 It is assumed that an average of 55 staff would reside within each of the six areas and two shuttle services would therefore be required to/ from each area. This equates to a total of eight shuttle services in the morning (16 movements) and eight shuttle services in the evening (16 movements). All shuttle services will travel to/ from the various access points, dependent on which zone the works are undertaken in. It has been assumed that 50% of shuttle services would travel via the A46 to the west (for Newark on Trent, Grantham and Sleaford) and 50% would travel via the A46 to the east (for Lincoln, Retford and Worksop).

- 7.4.15 If additional demand is identified by the monitoring carried out as part of the detailed CTMP then additional shuttle services will be provided to accommodate these and to further reduce the number of construction staff vehicles on the network.
- 7.4.16 The following assumptions have been adopted for the shuttle service which will be provided for non-local staff travelling to/ from the Proposed Development:
- a. The shuttle services will travel between the Principal Site and local settlements to transfer all non-local staff to and from the Proposed Development each day;
  - b. The shuttle services will depart from the Principal Site to pick-up construction workers from local settlements and return to the Principal Site within the hour prior to the start of a shift;
  - c. The shuttle services will depart from the Principal Site to drop-off construction workers back at each local settlement within the hour after the completion of a shift (before returning to the Proposed Development);
  - d. The shuttle services will each be expected to have a typical occupancy of 25-30 people when transferring construction workers; and,
  - e. A shuttle service round-trip (e.g. from the Principal Site to local worker accommodation in Lincoln for example, and then back to the Principal Site) is expected to take around 15-30 minutes on average (and so it has been assumed that a shuttle service would both depart and return during the same hour).
- 7.4.17 The above is designed to minimise vehicle trips on the surrounding highway network as far as possible.

### **Internal Movements**

- 7.4.18 The shuttle bus service will also be used to transport staff around different parts of the Principal Site (where required) by making use of the internal routes (where possible) to travel between the compounds and various parcels. This will minimise trips within the Principal Site and will also avoid trips on the surrounding highway network between the Proposed Development accesses.
- 7.4.19 Further to the above, shuttle buses will also be used to transfer staff between the Principal Site and the Cable Corridor.

## **7.5 Management Structure**

- 7.5.1 The overall management and implementation of this Framework CTMP and the detailed CTMP will be the responsibility of the Applicant. A Transport Co-ordinator will be appointed by the Applicant to implement, manage and develop the detailed CTMP at the appropriate time/ stage. The detailed CTMP will include the following information:
- a. Specifics of any carriageway widening or improvement works;
  - b. Specifics of the design of TTM measures;

- c. Details of the works to accesses, including provision of visibility splays;
  - d. Further details in respect of the design and management measures required to accommodate AILs; and
  - e. Information on sanctions for breaches of the routing strategies.
- 7.5.2 The Transport Co-ordinator, who takes responsibility for implementing the CTMP, will:
- a. Implement and monitor the CTMP to identify successful measures and areas for improvement;
  - b. Promote the CTMP to all staff and contractors travelling to and from the Proposed Development to ensure compliance with its contents;
  - c. Liaise as appropriate with local transport and traffic groups, local planning authorities and local highway authorities and National Highways;
  - d. Monitor data relating to HGV routes, timing of HGV arrivals and departures and compliance with the DMS/ TMMS;
  - e. Manage the Car Share Scheme;
  - f. Manage the shuttle bus service between local worker accommodation and the Principal Site (as well as the shuttle bus service to/ from the Cable Corridor access); and
  - g. Discuss any issues with relevant parties and identify any amendments to the CTMP (including measures) to ensure compliance is maintained.

## 7.6 Monitoring and Review

### HGVs

- 7.6.1 The detailed CTMP will be monitored and revised to ensure that contractors are complying with the document. This process will be led by the Transport Co-ordinator.
- 7.6.2 The Transport Co-ordinator will monitor data relating to HGV routes, timing of HGV arrivals and departures and compliance with the DMS/ TMMS. The results of the data monitoring will be reported to identify any issues which need to be resolved and any additional measures which should be implemented to these from arising again. The reports will be shared with the Applicant, local authority and the highway authorities (i.e. LCC Highways).

### Staff Vehicles

- 7.6.3 A Car Share Scheme will be implemented and managed by the Transport Co-ordinator, to match potential car sharers and to help staff identify any colleagues who could potentially be collected along their route to/ from the Principal Site.
- 7.6.4 The car share database will also be available to staff that have signed up, to allow them to identify their own potential matches. Car sharing staff will be

allocated spaces within the main construction compound so that they are guaranteed a parking space upon arrival.

- 7.6.5 Construction staff vehicles will be monitored when entering and exiting the Site. This monitoring will determine whether any additional measures should be explored to minimise staff trips on the local highway network.
- 7.6.6 Construction staff will be directed to available parking bays upon arrival to assist them to park in a timely manner. Given the working patterns identified, it is expected that the car park for the Principal Site will be managed between 06:00-08:00 in the mornings, when the majority of staff are expected to arrive.
- 7.6.7 Appropriate signage will be provided to clearly identify the entry and exit points to the car parks. It should be noted that the usage of the car park will be monitored and that the potential to introduce additional parking will be explored during peak construction if required.

### Additional Monitoring

- 7.6.8 The following monitoring will also be carried out during the construction phase of the Proposed Development, and secured as part of the detailed CTMP:
  - a. Construction vehicles (HGVs) will be monitored to ensure HGV drivers are adhering to the proposed routing strategy (**Figure 13-4: Heavy Goods Vehicle Routing** of the ES [EN010154/APP/6.2]); and
  - b. Road safety will be monitored within the DCO Site including at the proposed access points and at the internal PRow haul road crossing points.

## 8. Compliance and Enforcement

### 8.1 Introduction

8.1.1 This section of the Framework CTMP provides a summary of the mechanisms that will be implemented to maximise compliance with the CTMP.

### 8.2 Best Practice

8.2.1 The Applicant will use internal management procedures to maximise compliance and its enforcement with the requirements of the detailed CTMP, including:

- a. Contractor kick-off meetings: contractors will be reminded of the Applicant's standards and expectations as set out in contract documentation;
- b. Site induction: drivers will be briefed on the aims and objectives of the CTMP, including the booking system, designated routes and expected driver behaviour. A copy of the CTMP will be provided to each contractor to provide details of how the DCO Site will be managed as well as the rules and regulations; and,
- c. Reporting: incidences of non-compliance will be investigated within the CTMP. Reports from each incident will be raised and shared with the relevant contractor. The CTMP will be updated where necessary to resolve any ongoing issues.

### 8.3 Contractual Conditions

8.3.1 Each contractor will be provided with a contract setting out their contractual requirements in terms of compliance with the Framework and/ or detailed CTMP upon appointment. A copy of the CTMP will be provided along with details of the proposed routing strategy for HGVs to ensure that this route is followed.

### 8.4 Information Packs and Communications

8.4.1 Information packs will be provided to all contractors once they have been confirmed. The information pack will form part of the agreement between the Applicant and the designated contractors. The information pack will include details of the following:

- a. Code of Good Practice;
- b. Details of the Transport Co-ordinator;
- c. Delivery routing restrictions;
- d. Worker routing;
- e. Emergency procedures;
- f. Non-compliance guidance; and

- g. Complaint procedures.

## 8.5 Enforcement

- 8.5.1 The Applicant will take all reasonable steps to avoid any breach of the CTMP through the implementation of the management measures. However, should any breaches occur, then enforcement procedures will be followed:
  - a. The Transport Co-ordinator will notify the Applicant of any breaches of the CTMP arrangements as and when they occur.
  - b. The Applicant will issue a warning letter to the relevant contractor outlining what action would be taken in the event of any further non-compliance (in general terms).
  - c. The Applicant will report the details of the response to the Transport Co-ordinator as part of the monitoring report. The monitoring report will be made available to the relevant local planning authorities and relevant highway authorities at their request to ensure compliance and to demonstrate that action is being taken where necessary.
- 8.5.2 Further detail on the sanctions which could be applied will be included within the detailed CTMP.

## 9. Conclusion

- 9.1.1 The purpose of this Framework CTMP is to focus on the management of construction traffic along the local highway network within the vicinity of the Proposed Development during the construction period, in order to limit any potential disruptions and implications on the wider transport network. The **Framework PRow-MP [EN010154/APP/7.14]** identifies PRow to be potentially affected by the proposals and sets out measures to mitigate any impacts on these.
- 9.1.2 This Framework CTMP sets out the proposals to manage construction traffic and staff vehicles during the construction of the Proposed Development. It identifies the management of freight traffic i.e. Heavy Goods Vehicles (HGVs), as well as construction staff vehicles.
- 9.1.3 It should be noted that as this is a framework document, certain details will remain to be developed as the Proposed Development progresses into detailed design. The full details of all measures may not be available until after consent for the Proposed Development has been granted and will be provided within the detailed CTMP as necessary.



# Annex A Access Design Information Table

Drawing No.	Access Number	Access Ref.	Road Ref.	Visibility splays	Vehicle Tracking (Veh type)	Vehicle tracking (manoeuvre)	Last revision	Proposed Traffic Management	PR0W / Cycletrack	Vegetation / Hedgework Clearance	Additional considerations/works	MAX Hourly Movements (REV TRIP, Two-way) excludes ALs	MAX Daily Movements (REV TRIP, Two-way) excludes ALs	Comments / Concerns	CC Cable Drums required at each access	Visibility Splay Agreed by LCC	LCC Representative	Date
60700987	ACH-H2N-DR-CH-0001	PS	East Access off Fosse Lane	Junction Visibility DMRB 2.15m Junction Visibility Desirable Min. 1.13m Junction Visibility Absolute Min. 0.90m	Farm Tractor and shorter trailer (10.220m)	LEFT TURN OUT OF ACCESS ONTO FOSSE LANE HEADING SOUTH HEADING NORTH ON FOSSE LANE. MANOEUVRE RIGHT TURN INTO ACCESS	30/01/2025	NO	N/A	Vegetation clearance/ hedgework removal required to provide adequate visibility for the access	7.3T WEIGHT LIMIT EXCEPT FOR ACCESS/ IN EFFECT ON FOSSE LANE			No trips associated with the Scheme build out		# no trips associated with development, then no requirement to remove vegetation. Leave access as existing to serve existing traffic.	F	04/04/2025
60700987	ACH-H2N-DR-CH-0002	PS	West Access off Fosse Lane	Junction Visibility DMRB 2.15m Junction Visibility Desirable Min. 1.13m Junction Visibility Absolute Min. 0.90m	Articulated vehicle (16.5m)	RIGHT TURN OUT OF ACCESS ONTO FOSSE LANE HEADING SOUTH / LEFT TURN OUT OF ACCESS ONTO FOSSE LANE HEADING NORTH HEADING NORTH MANOEUVRE LEFT TURN INTO ACCESS/ HEADING SOUTH MANOEUVRE RIGHT TURN INTO ACCESS	23/11/2024	NO	N/A	Vegetation clearance/ hedgework removal required to provide adequate visibility for the access	OVERHEAD CABLES 100m to the south of the access	179	478	Clear to absolute minimum (120m)			F	04/04/2025
60700987	ACH-H2N-DR-CH-0003	PS	Haddington Lane (North)	Junction Visibility DMRB 2.15m Junction Visibility Desirable Min. 1.13m Junction Visibility Absolute Min. 0.90m	Articulated vehicle (16.5m)	LEFT TURN OUT OF ACCESS ONTO HADDINGTON LANE HEADING NORTH / RIGHT TURN OUT OF ACCESS ONTO HADDINGTON LANE HEADING SOUTH / EGRESS HEADING SOUTH ON HADDINGTON LANE RIGHT TURN INTO ACCESS/ VEHICLE HEADING SOUTH ON HADDINGTON LANE RIGHT TURN INTO ACCESS	23/11/2024	NO	N/A	Vegetation clearance/ hedgework removal required to provide adequate visibility for the access	N/A	48	120	Clear to Absolute Minimum Splay (140m)			F	04/04/2025
60700987	ACH-H2N-DR-CH-0004	PS	The Avenue	Junction Visibility DMRB 2.15m Junction Visibility Desirable Min. 1.13m Junction Visibility Absolute Min. 0.90m	Articulated vehicle (16.5m) D632 Fire Appliance (6.680m)	LEFT TURN OUT OF ACCESS ONTO THE AVENUE HEADING SOUTH HEADING NORTH ON THE AVENUE MANOEUVRE RIGHT TURN INTO ACCESS	23/11/2024	YES - EGRESS MOVEMENTS TO BE BANKSPERSON CONTROLLED TO ENSURE THAT NO EGRESS MOVEMENT IS UNDERTAKEN AT THE SAME TIME AS ARRIVING CONSTRUCTION TRAFFIC.	PUBLIC BRIDLEWAY TOH/12/1	Vegetation clearance to provide adequate visibility for the access	ACCESS AND EGRESS FROM THE SOUTH ONLY FOR CONSTRUCTION TRAFFIC	179	478	No comment - the Avenue is not public highway			F	04/04/2025
60700987	ACH-H2N-DR-CH-0005	PS	Stone Lane	Junction Visibility DMRB 2.15m Junction Visibility Desirable Min. 1.13m Junction Visibility Absolute Min. 0.90m	Articulated vehicle (16.5m)	VEHICLE CROSSING STONE LANE HEADING SOUTH / VEHICLE CROSSING STONE LANE HEADING NORTH	23/11/2024	YES - EGRESS MOVEMENTS TO BE BANKSPERSON CONTROLLED TO ENSURE THAT NO EGRESS MOVEMENT IS UNDERTAKEN AT THE SAME TIME AS ARRIVING CONSTRUCTION TRAFFIC.	Cycle track to the west of the access	Vegetation clearance to provide adequate visibility for the access	SECTION OF STONE LANE CLOSED TO VEHICULAR TRAFFIC	23	52	80m visibility splay acceptable for cycles (no vehicles on this section of Stone Lane)			F	04/04/2025
60700987	ACH-H2N-DR-CH-0006	PS	Haddington Lane (East)	Junction Visibility DMRB 2.15m Junction Visibility Desirable Min. 1.13m Junction Visibility Absolute Min. 0.90m	Articulated vehicle (16.5m)	LEFT TURN ONTO HADDINGTON LANE HEADING SOUTH / RIGHT TURN ONTO HADDINGTON LANE HEADING NORTH / VEHICLE HEADING SOUTH ON HADDINGTON LANE LEFT TURN INTO ACCESS/ EGRESS HEADING NORTH ON HADDINGTON LANE RIGHT TURN INTO ACCESS	23/11/2024	YES - EGRESS MOVEMENTS TO BE BANKSPERSON CONTROLLED TO ENSURE THAT NO EGRESS MOVEMENT IS UNDERTAKEN AT THE SAME TIME AS ARRIVING CONSTRUCTION TRAFFIC.	N/A	Vegetation clearance/ hedgework removal required to provide adequate visibility for the access	OVERHEAD CABLES 50m to the north of the access/ access track could potentially overtop FOOTPATH AUTO'S 1/2 circa 150m east of the access point	23	53	Clear to Absolute Minimum Splay (131m)			F	04/04/2025
60700987	ACH-H2N-DR-CH-0007	PS	Haddington Lane (West)	Junction Visibility DMRB 2.15m Junction Visibility Desirable Min. 1.13m Junction Visibility Absolute Min. 0.90m	Articulated vehicle (16.5m)	RIGHT TURN OUT OF ACCESS ONTO HADDINGTON LANE HEADING SOUTH / LEFT TURN OUT OF ACCESS ONTO HADDINGTON LANE HEADING NORTH / VEHICLE HEADING NORTH ON HADDINGTON LANE LEFT TURN INTO ACCESS/ VEHICLE HEADING SOUTH ON HADDINGTON LANE LEFT TURN INTO ACCESS	30/01/2025	NO	N/A	Vegetation clearance/ hedgework removal required to provide adequate visibility for the access	N/A	39	112	Clear to Absolute Minimum Splays (131m)			F	04/04/2025
60700987	ACH-H2N-DR-CH-0008	PS	Moor Lane (South)	Junction Visibility DMRB 2.15m Junction Visibility Desirable Min. 1.13m Junction Visibility Absolute Min. 0.90m	Articulated vehicle (16.5m)	RIGHT TURN OUT OF ACCESS HEADING EAST ON MOOR LANE / LEFT TURN OUT OF ACCESS HEADING WEST ON MOOR LANE / VEHICLE HEADING EAST ON MOOR LANE RIGHT TURN INTO ACCESS/ VEHICLE HEADING WEST ON MOOR LANE LEFT TURN INTO ACCESS	23/11/2024	YES - EGRESS MOVEMENTS TO BE BANKSPERSON CONTROLLED TO ENSURE THAT NO EGRESS MOVEMENT IS UNDERTAKEN AT THE SAME TIME AS ARRIVING CONSTRUCTION TRAFFIC.	PUBLIC FOOTPATH (ENTRY/ EXIT) THA/N/21	Vegetation clearance to provide adequate visibility for the access	PR0W THA/N/21 will require management to oversee the movements between construction vehicles and PR0W users/ Drainage ditch running alongside the access track	96	612	Visibility splay absolute minimum 131m - no clearance necessary. Given high number of vehicles using this access and the very tight swept paths on existing footpaths, the access should be widened and aligned to 21m			F	04/04/2025
60700987	ACH-H2N-DR-CH-0009	PS	Bassingham Road	Junction Visibility DMRB 2.15m Junction Visibility Desirable Min. 1.13m Junction Visibility Absolute Min. 0.90m	Articulated vehicle (16.5m) AL 16-AILE ORDER TRAILER (46.625m)	LEFT TURN OUT OF ACCESS ONTO BASSINGHAM ROAD HEADING WEST / RIGHT TURN INTO ACCESS/ VEHICLE HEADING WEST ON BASSINGHAM ROAD LEFT TURN INTO ACCESS	24/03/2025	YES - EGRESS MOVEMENTS TO BE BANKSPERSON CONTROLLED TO ENSURE THAT NO EGRESS MOVEMENT IS UNDERTAKEN AT THE SAME TIME AS ARRIVING CONSTRUCTION TRAFFIC.	N/A	Vegetation clearance/ hedgework removal required to provide adequate visibility for the access	Access to be utilised by an AL to transport the Transformer from the west	53	360	Trips via C-009 utilising only a portion on Fen Lane in a scenario that the Haul Road from C-009 to C-013 is unavailable	21*	Achieved visibility splays of 80/90m acceptable for road alignment and speeds	F	04/04/2025
60700987	ACH-H2N-DR-CH-0010	PS	West Access off Lincoln Road	Junction Visibility DMRB 2.15m Junction Visibility Desirable Min. 1.13m Junction Visibility Absolute Min. 0.90m	Articulated vehicle (16.5m)	LEFT TURN OUT OF ACCESS ONTO LINCOLN ROAD HEADING NORTH / RIGHT TURN INTO ACCESS/ VEHICLE HEADING NORTH ON LINCOLN ROAD LEFT TURN INTO ACCESS	30/01/2025	NO	N/A	Vegetation clearance to provide adequate visibility for the access	N/A	25	69	Clear to Absolute Minimum Splays (114m)			F	04/04/2025
60700987	ACH-H2N-DR-CH-0011	PS	Clay Lane North (West)	Junction Visibility DMRB 2.15m Junction Visibility Desirable Min. 1.13m Junction Visibility Absolute Min. 0.90m	Articulated vehicle (16.5m)	LEFT TURN OUT OF ACCESS ONTO CLAY LANE HEADING NORTH / RIGHT TURN INTO ACCESS/ VEHICLE HEADING NORTH ON CLAY LANE LEFT TURN INTO ACCESS	23/11/2024	YES - EGRESS MOVEMENTS TO BE BANKSPERSON CONTROLLED TO ENSURE THAT NO EGRESS MOVEMENT IS UNDERTAKEN AT THE SAME TIME AS ARRIVING CONSTRUCTION TRAFFIC.	N/A	Vegetation clearance/ hedgework removal required to provide adequate visibility for the access	N/A	42	327	No HDVs - with a caveat of 28 indivisible HDV trips associated within the transformers - this will be set out within the CTMP (not 28 daily movements this is a number associated with the total)			F	04/04/2025
60700987	ACH-H2N-DR-CH-0012	PS	Clay Lane North (East)	Junction Visibility DMRB 2.15m Junction Visibility Desirable Min. 1.13m Junction Visibility Absolute Min. 0.90m	Articulated vehicle (16.5m)	RIGHT TURN OUT OF ACCESS ONTO CLAY LANE HEADING NORTH / LEFT TURN INTO ACCESS/ VEHICLE HEADING SOUTH ON CLAY LANE HEADING NORTH ON CLAY LANE HEADING NORTH / LEFT TURN INTO ACCESS	23/11/2024	YES - EGRESS MOVEMENTS TO BE BANKSPERSON CONTROLLED TO ENSURE THAT NO EGRESS MOVEMENT IS UNDERTAKEN AT THE SAME TIME AS ARRIVING CONSTRUCTION TRAFFIC.	N/A	Vegetation clearance/ hedgework removal required to provide adequate visibility for the access	N/A	42	369	Clear to Absolute Minimum Splays (61m) - Can 11 and 12 be shown on one drawing? 7 Accesses are nearly opposite, any traffic crossing Clay Lane?			F	04/04/2025
60700987	ACH-H2N-DR-CH-0013	CC	Fen Lane	Junction Visibility DMRB 2.15m Junction Visibility Absolute Min. 0.90m	Articulated vehicle (16.5m)	ARTICULATED VEHICLE MANOEUVRE ALONG FEN LANE HEADING EAST / ARTICULATED VEHICLE MANOEUVRE ALONG FEN LANE HEADING WEST	23/11/2024	NO	FOOTPATH Bars 23/1	NO	N/A	2	60	Trips via C-009 utilising only a portion on Fen Lane in a scenario that the Haul Road from C-009 to C-013 is unavailable	21*	Visibility splay acceptable. Passing places needed on Fen Lane, this access is 20m from Lincoln Road down single track lane.	F	04/04/2025
60700987	ACH-H2N-DR-CH-0014	CC	Broughton Lane	Junction Visibility DMRB 2.15m Junction Visibility Desirable Min. 1.13m Junction Visibility Absolute Min. 0.90m	Articulated vehicle (16.5m)	RIGHT TURN OUT OF ACCESS ONTO BROUGHTON LANE HEADING SOUTH / LEFT TURN OUT OF ACCESS ONTO BROUGHTON LANE HEADING NORTH / VEHICLE HEADING NORTH ON BROUGHTON LANE LEFT TURN INTO ACCESS/ VEHICLE HEADING SOUTH ON BROUGHTON LANE RIGHT TURN INTO ACCESS	23/11/2024	YES - EGRESS MOVEMENTS TO BE BANKSPERSON CONTROLLED TO ENSURE THAT NO EGRESS MOVEMENT IS UNDERTAKEN AT THE SAME TIME AS ARRIVING CONSTRUCTION TRAFFIC.	N/A	Vegetation clearance to provide adequate visibility for the access	N/A	2	60	215m Visibility splay acceptable	3		F	04/04/2025
60700987	ACH-H2N-DR-CH-0015	CC	Hill Rise	Junction Visibility DMRB 2.15m Junction Visibility Desirable Min. 1.13m Junction Visibility Absolute Min. 0.90m	Articulated vehicle (16.5m)	LEFT TURN OUT OF ACCESS ONTO HILL RISE HEADING WEST / RIGHT TURN INTO ACCESS/ VEHICLE HEADING EAST / VEHICLE HEADING WEST ON HILL RISE LEFT TURN INTO ACCESS/ VEHICLE HEADING EAST ON HILL RISE RIGHT TURN INTO ACCESS	23/11/2024	NO	N/A	Vegetation clearance to provide adequate visibility for the access	EXISTING CULVERT TO BE WIDENED AND STRUCTURAL LOADING ASSESSMENT NECESSARY/ Damage ditch running alongside Hill Rise	2	60	90m Absolute Minimum Visibility splay acceptable			F	04/04/2025
60700987	ACH-H2N-DR-CH-0016	CC	Rose Cottage Lane (West)	Junction Visibility DMRB 2.15m Junction Visibility Desirable Min. 1.13m Junction Visibility Absolute Min. 0.90m	Articulated vehicle (16.5m)	LEFT TURN OUT OF ACCESS ONTO ROSE COTTAGE LANE HEADING NORTH / RIGHT TURN INTO ACCESS/ VEHICLE HEADING NORTH ON ROSE COTTAGE LANE RIGHT TURN INTO ACCESS	23/11/2024	YES - EGRESS MOVEMENTS TO BE BANKSPERSON CONTROLLED TO ENSURE THAT NO EGRESS MOVEMENT IS UNDERTAKEN AT THE SAME TIME AS ARRIVING CONSTRUCTION TRAFFIC.	N/A	Vegetation clearance to provide adequate visibility for the access	OVERHEAD CABLE 100m to the south of the access/ Access C-016 located opposite to Access C-017	2	60	Visibility splay acceptable. Can 16 and 17 be shown on same drawing as they are nearly opposite.			F	04/04/2025
60700987	ACH-H2N-DR-CH-0017	CC	Rose Cottage Lane (East)	Junction Visibility DMRB 2.15m Junction Visibility Desirable Min. 1.13m Junction Visibility Absolute Min. 0.90m	Articulated vehicle (16.5m)	LEFT TURN OUT OF ACCESS ONTO ROSE COTTAGE LANE HEADING SOUTH / RIGHT TURN INTO ACCESS/ VEHICLE HEADING SOUTH ON ROSE COTTAGE LANE LEFT TURN INTO ACCESS	23/11/2024	YES - EGRESS MOVEMENTS TO BE BANKSPERSON CONTROLLED TO ENSURE THAT NO EGRESS MOVEMENT IS UNDERTAKEN AT THE SAME TIME AS ARRIVING CONSTRUCTION TRAFFIC.	N/A	Vegetation clearance to provide adequate visibility for the access	OVERHEAD CABLE 100m to the south of the access/ Access C-017 located opposite to Access C-017	2	60	Visibility splay acceptable. Can 16 and 17 be shown on same drawing as they are nearly opposite.			F	04/04/2025
60700987	ACH-H2N-DR-CH-0018	CC	Green Man Road	Junction Visibility DMRB 2.15m Junction Visibility Desirable Min. 1.13m Junction Visibility Absolute Min. 0.90m	Articulated vehicle (16.5m)	LEFT TURN OUT OF ACCESS ONTO GREEN MAN ROAD HEADING EAST / VEHICLE HEADING WEST ON GREEN MAN ROAD LEFT TURN INTO ACCESS/ VEHICLE HEADING EAST ON GREEN MAN ROAD RIGHT TURN INTO ACCESS	23/11/2024	NO	N/A	Vegetation clearance to provide adequate visibility for the access	OVERHEAD CABLE 150m to the west of the access	2	60	80m Absolute Minimum Visibility splay acceptable			F	04/04/2025
60700987	ACH-H2N-DR-CH-0019	CC	Green Man Road (east)	Junction Visibility DMRB 2.15m Junction Visibility Desirable Min. 1.13m Junction Visibility Absolute Min. 0.90m	Articulated vehicle (16.5m)	LEFT TURN OUT OF ACCESS ONTO GREEN MAN ROAD HEADING WEST / RIGHT TURN INTO ACCESS/ VEHICLE HEADING WEST ON GREEN MAN ROAD LEFT TURN INTO ACCESS / HEADING EAST ON GREEN MAN ROAD RIGHT TURN INTO ACCESS	13/05/2025	NO	N/A	Vegetation clearance to provide adequate visibility for the access	N/A	2	60	Drawing 0018 shows Heath Lane not Green Man Road (east) ? Please advise			F	04/04/2025
60700987	ACH-H2N-DR-CH-0020	PS	Haddington Lane (North)	Junction Visibility DMRB 2.15m Junction Visibility Desirable Min. 1.13m Junction Visibility Absolute Min. 0.90m	Articulated vehicle (16.5m)	LEFT TURN OUT OF ACCESS ONTO HADDINGTON LANE HEADING NORTH / RIGHT TURN INTO ACCESS/ VEHICLE HEADING SOUTH ON HADDINGTON LANE LEFT TURN INTO ACCESS	23/11/2024	NO	N/A	Vegetation clearance/ hedgework removal required to provide adequate visibility for the access	N/A	11	31	Clear to Absolute Minimum Splays (131m)			F	04/04/2025
60700987	ACH-H2N-DR-CH-0021	PS Operational Access	Clay Lane (Track)	Junction Visibility DMRB 2.15m Junction Visibility Desirable Min. 1.13m Junction Visibility Absolute Min. 0.90m	D632 Fire Appliance (6.680m)	LEFT TURN OUT OF ACCESS ONTO CLAY LANE HEADING WEST / TURNING RIGHT ONTO CLAY LANE HEADING EAST / VEHICLE HEADING EAST ON CLAY LANE RIGHT TURN INTO ACCESS/ VEHICLE HEADING WEST ON CLAY LANE LEFT TURN INTO ACCESS	23/11/2024	NO	FOOTPATH TOH/7/2	Vegetation clearance to provide adequate visibility for the access	N/A			No comment - Clay Lane (track) is not public highway			F	04/04/2025
60700987	ACH-H2N-DR-CH-0022	PS Operational Access	Fosse Lane	Junction Visibility DMRB 2.15m Junction Visibility Desirable Min. 1.13m Junction Visibility Absolute Min. 0.90m	D632 Fire Appliance (6.680m)	LEFT TURN OUT OF ACCESS ONTO FOSSE LANE HEADING NORTH / TURNING RIGHT ONTO HADDINGTON LANE HEADING SOUTH / VEHICLE HEADING NORTH ON HADDINGTON LANE LEFT TURN INTO ACCESS/ VEHICLE HEADING SOUTH ON HADDINGTON LANE RIGHT TURN INTO ACCESS	23/11/2024	NO	N/A	Vegetation clearance/ hedgework removal required to provide adequate visibility for the access	N/A			Existing farm access - no requirement to improve splays for small number of operational vehicles (similar to existing farm traffic).			F	04/04/2025
60700987	ACH-H2N-DR-CH-0023	PS Operational Access	Haddington Lane	Junction Visibility DMRB 2.15m Junction Visibility Desirable Min. 1.13m Junction Visibility Absolute Min. 0.90m	D632 Fire Appliance (6.680m)	RIGHT TURN OUT OF ACCESS ONTO HADDINGTON LANE HEADING NORTH / LEFT TURN INTO ACCESS/ VEHICLE HEADING SOUTH ON HADDINGTON LANE RIGHT TURN INTO ACCESS	23/11/2024	NO	N/A	Vegetation clearance/ hedgework removal required to provide adequate visibility for the access	N/A			Existing farm access - no requirement to improve splays for small number of operational vehicles (similar to existing farm traffic).			F	04/04/2025
60700987	ACH-H2N-DR-CH-0024	PS Operational Access	Moor Lane (North)	Junction Visibility DMRB 2.15m Junction Visibility Desirable Min. 1.13m Junction Visibility Absolute Min. 0.90m	D632 Fire Appliance (6.680m)	LEFT TURN OUT OF ACCESS ONTO MOOR LANE HEADING EAST / RIGHT TURN INTO ACCESS/ VEHICLE HEADING WEST ON MOOR LANE HEADING WEST / HEADING WEST ON MOOR LANE LEFT TURN INTO ACCESS	23/11/2024	NO	FOOTPATH THA/ 2/1; 3/1	Vegetation clearance required to provide adequate visibility for the access	Existing junction footprint to be retained			Existing farm access - no requirement to improve splays for small number of operational vehicles (similar to existing farm traffic).			F	04/04/2025
60700987	ACH-H2N-DR-CH-0025	PS Operational Access	Fen Lane (West)	Junction Visibility DMRB 2.15m Junction Visibility Desirable Min. 1.13m Junction Visibility Absolute Min. 0.90m	D632 Fire Appliance (6.680m)	LEFT TURN OUT OF ACCESS ONTO FEN LANE HEADING EAST / RIGHT TURN INTO ACCESS/ VEHICLE HEADING WEST ON FEN LANE HEADING WEST / HEADING WEST ON FEN LANE RIGHT TURN INTO ACCESS	23/11/2024	NO	N/A	Vegetation clearance required to provide adequate visibility for the access	N/A			Access suitable for operational traffic			F	04/04/2025
60700987	ACH-H2N-DR-CH-0026	PS Operational Access	Fen Lane (East)	Junction Visibility DMRB 2.15m Junction Visibility Desirable Min. 1.13m Junction Visibility Absolute Min. 0.90m	D632 Fire Appliance (6.680m)	LEFT TURN OUT OF ACCESS ONTO FEN LANE HEADING EAST / RIGHT TURN INTO ACCESS/ VEHICLE HEADING WEST ON FEN LANE HEADING WEST / HEADING EAST ON FEN LANE LEFT TURN INTO ACCESS	23/11/2024	NO	N/A	Vegetation clearance required to provide adequate visibility for the access	N/A			Access suitable for operational traffic			F	04/04/2025
60700987	ACH-H2N-DR-CH-0027	PS Operational Access	Clay Lane (Norton Disney)	Junction Visibility DMRB 2.15m Junction Visibility Desirable Min. 1.13m Junction Visibility Absolute Min. 0.90m	D632 Fire Appliance (6.680m)	LEFT TURN OUT OF ACCESS ONTO CLAY LANE HEADING EAST / RIGHT TURN INTO ACCESS/ VEHICLE HEADING EAST ON CLAY LANE LEFT TURN INTO ACCESS	23/11/2024	NO	N/A	Vegetation clearance required to provide adequate visibility for the access	N/A			Access suitable for operational traffic			F	04/04/2025
60700987	ACH-H2N-DR-CH-0028	PS Emergency Access ONLY	Morton Lane	Junction Visibility DMRB 2.15m Junction Visibility Desirable Min. 1.13m Junction Visibility Absolute Min. 0.90m	D632 Fire Appliance (6.680m)	HEADING NORTH ON MORTON LANE	23/11/2024	NO	BRIDLEWAY TOH/21/2	NO	N/A			No comment - Morton Lane is not public highway			F	04/04/2025
60700987	ACH-H2N-DR-CH-0029	PS Emergency Access ONLY	Bassingham Road (West)	Junction Visibility DMRB 2.15m Junction Visibility Desirable Min. 1.13m Junction Visibility Absolute Min. 0.90m	D632 Fire Appliance (6.680m)	LEFT TURN OUT OF ACCESS ONTO BASSINGHAM ROAD HEADING NORTH / RIGHT TURN INTO ACCESS/ VEHICLE HEADING SOUTH ON BASSINGHAM ROAD RIGHT TURN INTO ACCESS	23/11/2024	NO	N/A	Vegetation clearance/ hedgework removal required to provide adequate visibility for the access	N/A			Existing farm access - no requirement to improve splays emergency vehicle			F	04/04/2025
0700987	ACH-H2N-DR-CH-0030	PS Emergency Access ONLY	Aubourn Moor	Junction Visibility DMRB 2.15m Junction Visibility Desirable Min. 1.13m Junction Visibility Absolute Min. 0.90m	D632 Fire Appliance (6.680m)	LEFT TURN OUT OF ACCESS ONTO AUBOURN MOOR HEADING WEST / RIGHT TURN INTO ACCESS/ VEHICLE HEADING WEST ON AUBOURN MOOR HEADING EAST / VEHICLE HEADING EAST ON AUBOURN MOOR RIGHT TURN INTO ACCESS	23/11/2024	NO	N/A	Vegetation clearance to provide adequate visibility for the access	N/A			No comment - Aubourn Moor Lane is not public highway			F	04/04/2025

# Annex B Proposed Site Access Layouts, Visibility Splays and Swept Paths (Principal Site and Cable Corridor)

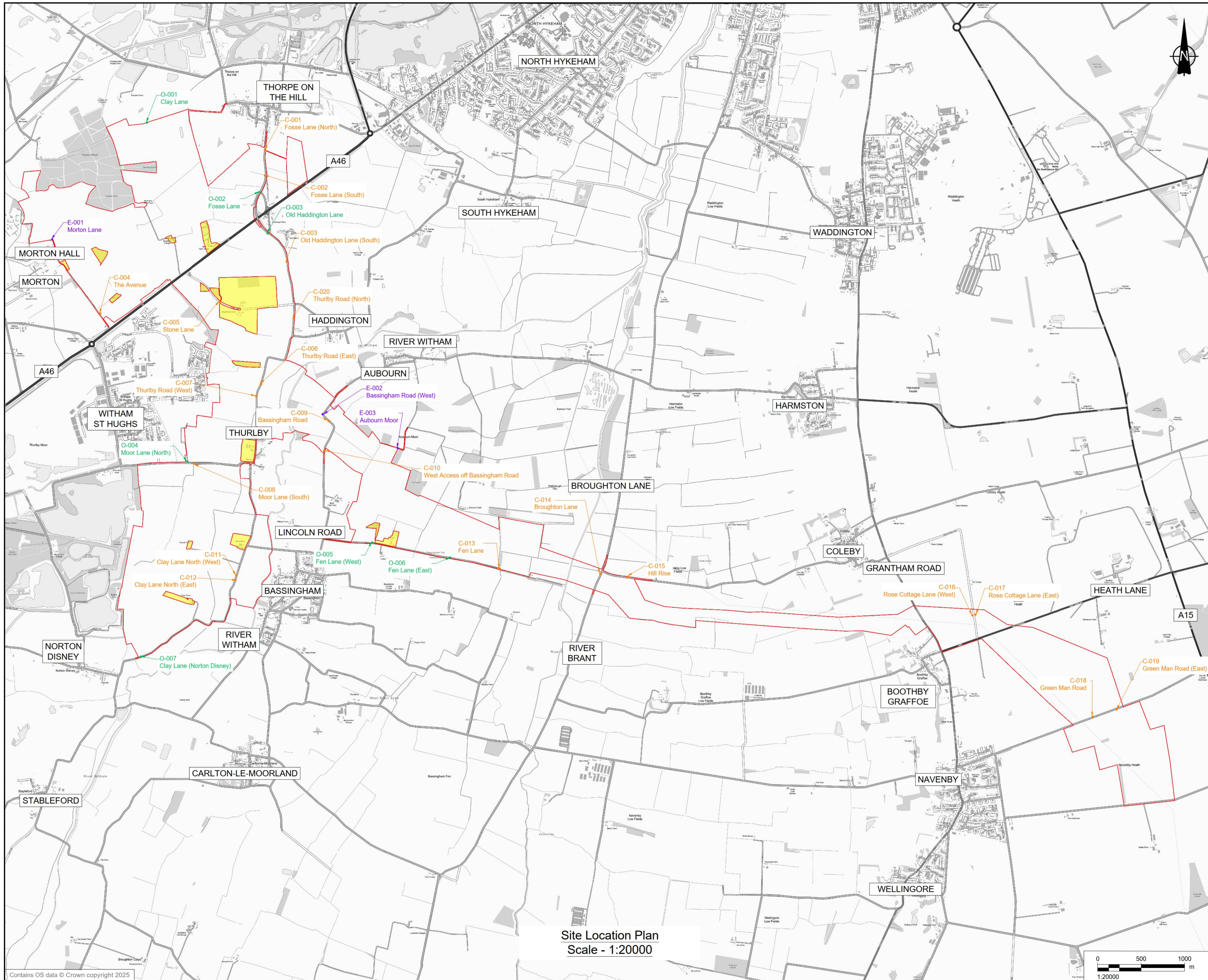

This drawing has been prepared for the use of AECOM's client. It may not be used, modified, reproduced or relied upon by third parties, except as agreed by AECOM or as required by law. AECOM accepts no responsibility, and denies any liability whatsoever, to any party that uses or relies on this drawing without AECOM's express written consent. Do not scale this document.



**PROJECT**  
 Fosse Green Energy

**CLIENT**  
 Fosse Green Energy Ltd

**CONSULTANT**  
 AECOM

**LEGEND**

DCO SITE BOUNDARY	
LAND NOT INCLUDED IN THE DCO SITE BOUNDARY	
CONSTRUCTION ACCESS	
OPERATIONAL ACCESS	
EMERGENCY ACCESS	

Site Location Plan  
 Scale - 1:20000

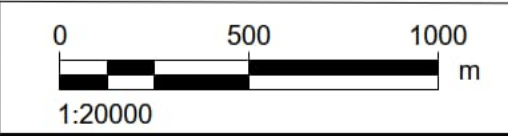

**ISSUE/REVISION**

NO	DATE	DESCRIPTION
P02	03/09/2025	OS MAP UPDATED
P01	17/07/2025	DCO SUBMISSION
J/R	DATE	DESCRIPTION

**LEGISLATION**  
 Regulation 5(2)(k) Infrastructure Planning  
 (Applications: Prescribed Forms and Procedure) Regulations 2009

**ISSUE PURPOSE**  
 DCO SUBMISSION

FIGURE NUMBER	REV.
SITE LOCATION PLAN	02
<b>DOCUMENT REFERENCE</b>	

EN10154/APP/7.18

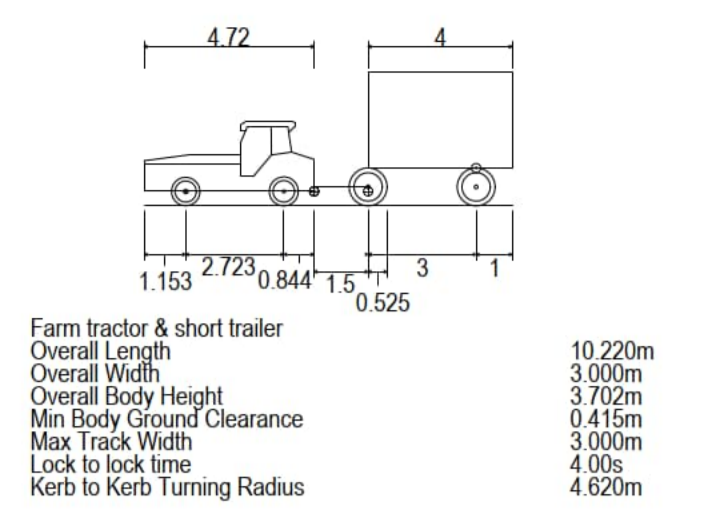
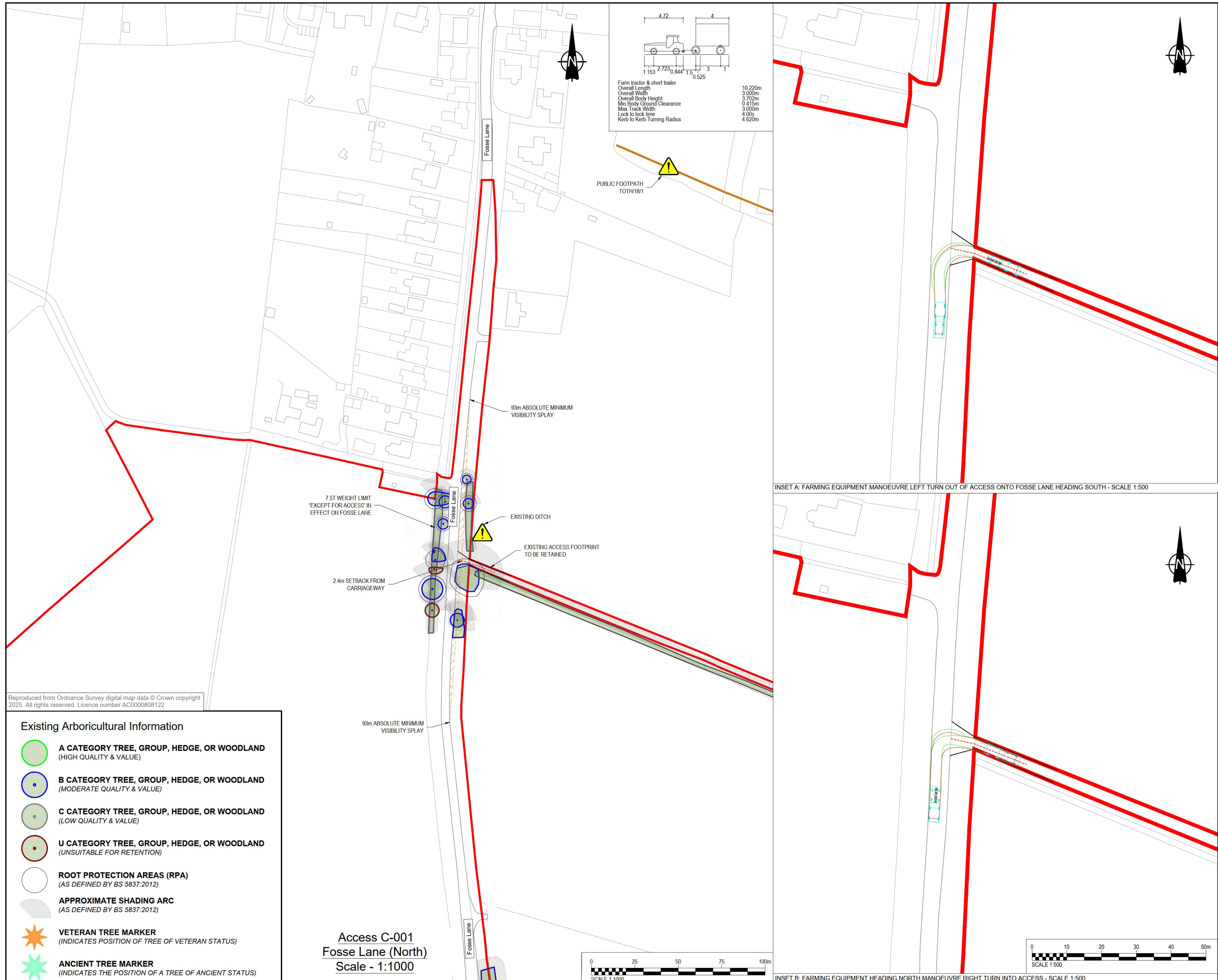

INSET A: FARMING EQUIPMENT MANOEUVRE LEFT TURN OUT OF ACCESS ONTO FOSSE LANE HEADING SOUTH - SCALE 1:500

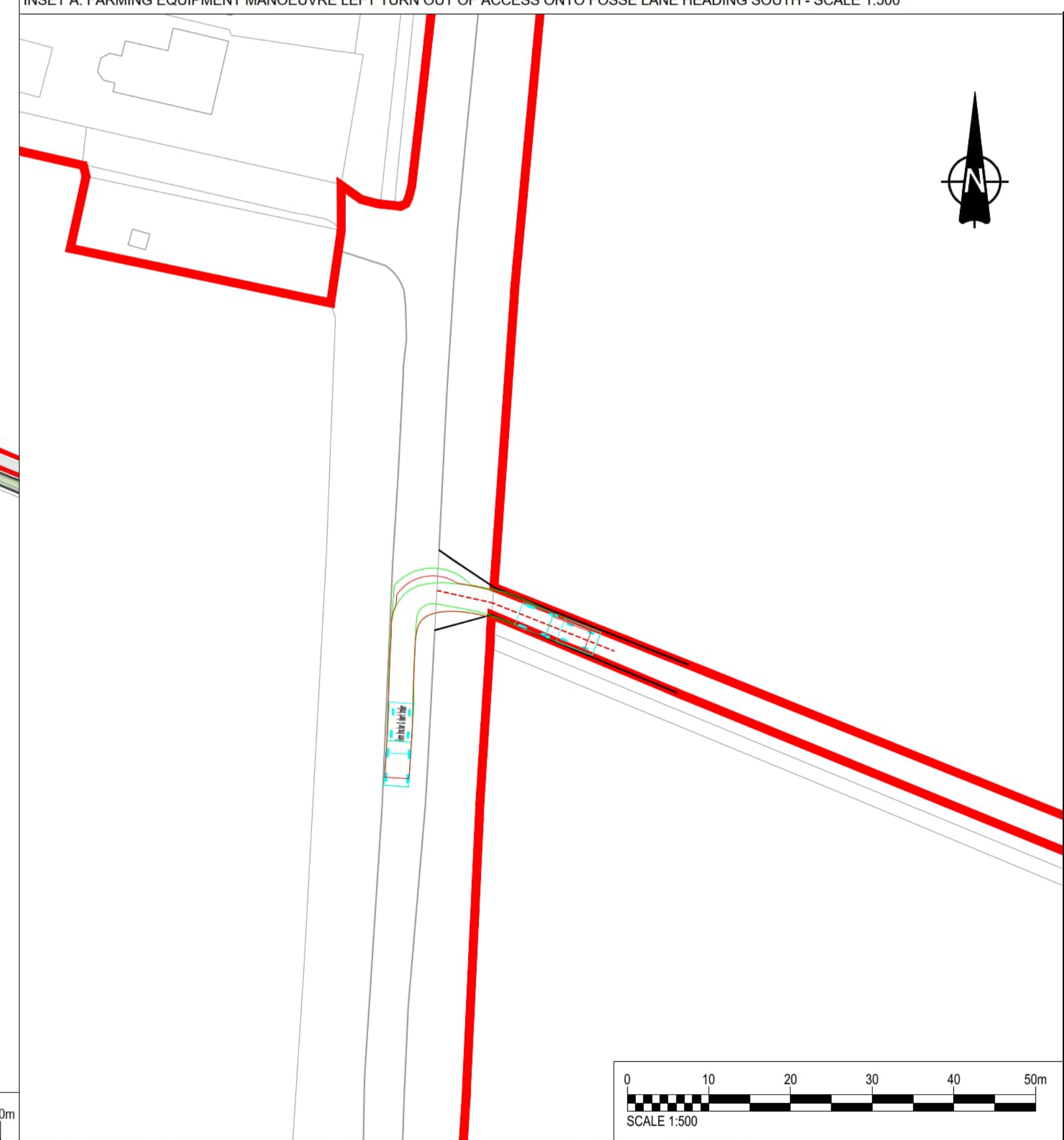

INSET B: FARMING EQUIPMENT HEADING NORTH MANOEUVRE RIGHT TURN INTO ACCESS - SCALE 1:500

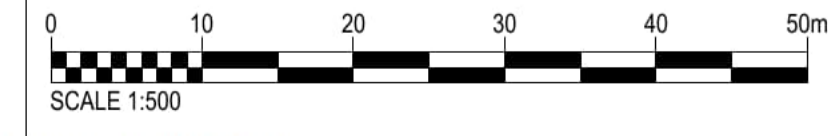
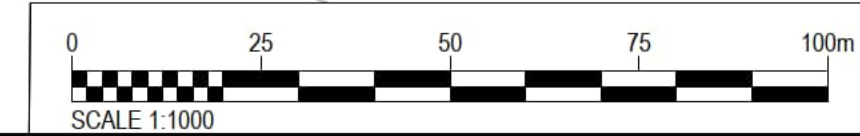

**Existing Arboricultural Information**

- A CATEGORY TREE, GROUP, HEDGE, OR WOODLAND** (HIGH QUALITY & VALUE)
- B CATEGORY TREE, GROUP, HEDGE, OR WOODLAND** (MODERATE QUALITY & VALUE)
- C CATEGORY TREE, GROUP, HEDGE, OR WOODLAND** (LOW QUALITY & VALUE)
- U CATEGORY TREE, GROUP, HEDGE, OR WOODLAND** (UNSUITABLE FOR RETENTION)
- ROOT PROTECTION AREAS (RPA)** (AS DEFINED BY BS 5837:2012)
- APPROXIMATE SHADING ARC** (AS DEFINED BY BS 5837:2012)
- VETERAN TREE MARKER** (INDICATES POSITION OF TREE OF VETERAN STATUS)
- ANCIENT TREE MARKER** (INDICATES THE POSITION OF A TREE OF ANCIENT STATUS)

**Access C-001**  
**Fosse Lane (North)**  
**Scale - 1:1000**



**PROJECT**  
**Fosse Green Energy**

**CLIENT**  
**Fosse Green Energy Ltd**

**CONSULTANT**  
**AECOM**

- NOTES**
- This drawing is to be read in conjunction with all other relevant documentation.
  - Do not scale from this drawing, use only printed dimensions.
  - All dimensions in meters, all chainages, levels and coordinates are in meters unless defined otherwise.
  - This drawing is to be read in conjunction with the project Health & Safety File for any identified potential risks.
  - Vegetation to be removed denotes any vegetation features (such as hedgerows) that need to be removed to provide the required junction visibility. Any verge grassland is not to be removed but managed by the relevant maintainer to a low height so as to not impact upon junction visibility.
  - Vehicle tracking shown is indicative only, and represents approximate vehicle size & arrangement for the design vehicle shown.
  - Junction visibility for the access is based upon visibility parameters derived using 85th Percentile Speed Survey Data received on 1st December 2023.
  - These plans should also be read in conjunction with ES Volume 6.2 Appendix 10-H Arboricultural Impact Assessment, for details on hedgerow removal and tree protection

- LEGEND**
- Extent of Access Footprint
  - DCO Site Boundary
  - Existing Public Rights of Way
  - Vehicle body
  - Vehicle body path
  - Vehicle load
  - Vehicle load path
  - Vehicle wheels path
  - Edge of road
  - Land not included in the DCO Site Boundary
  - Junction Visibility Absolute Min.
  - Vegetation to be removed Absolute Min. Vis Splay
  - Junction Visibility DMRB Min.
  - Vegetation to be removed DMRB Min. Vis Splay
  - Indicative Hedgerow Removal Absolute Min. Vis Splay
  - Indicative Hedgerow Removal for Bellmouth Access
  - Approximate Structure Footprint
  - Health and Safety Risk Identifier

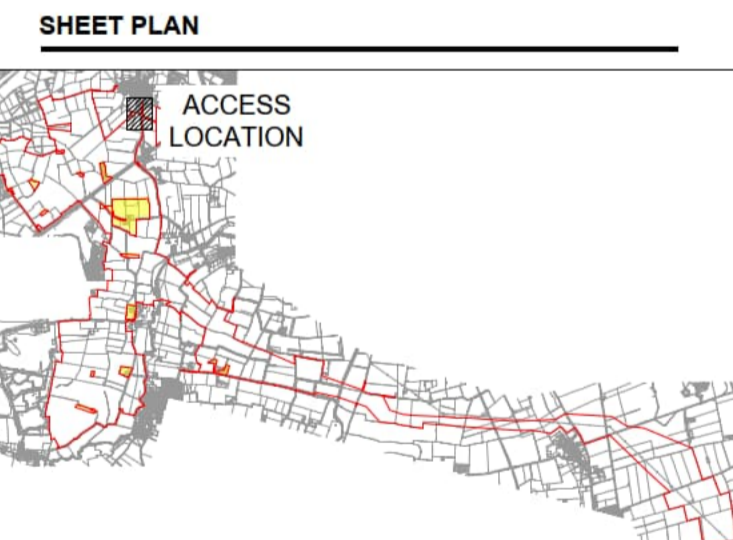

**ISSUE/REVISION**

NO.	DATE	DESCRIPTION
P01	17/07/2025	DCO SUBMISSION

**LEGISLATION**  
 Regulation 5(2)(k) Infrastructure Planning (Applications: Prescribed Forms and Procedure) Regulations 2009

**ISSUE PURPOSE**  
 DCO SUBMISSION

**FIGURE TITLE**

FIGURE TITLE	REV.
ACCESS C-001	01

**DOCUMENT REFERENCE**  
 EN10154/APP/7.18

This drawing has been prepared for the use of AECOM's client. It may not be used, modified, reproduced or relied upon by third parties, except as agreed by AECOM or as required by law. AECOM accepts no responsibility, and denies any liability whatsoever, to any party that uses or relies on this drawing without AECOM's express written consent. Do not scale this document.



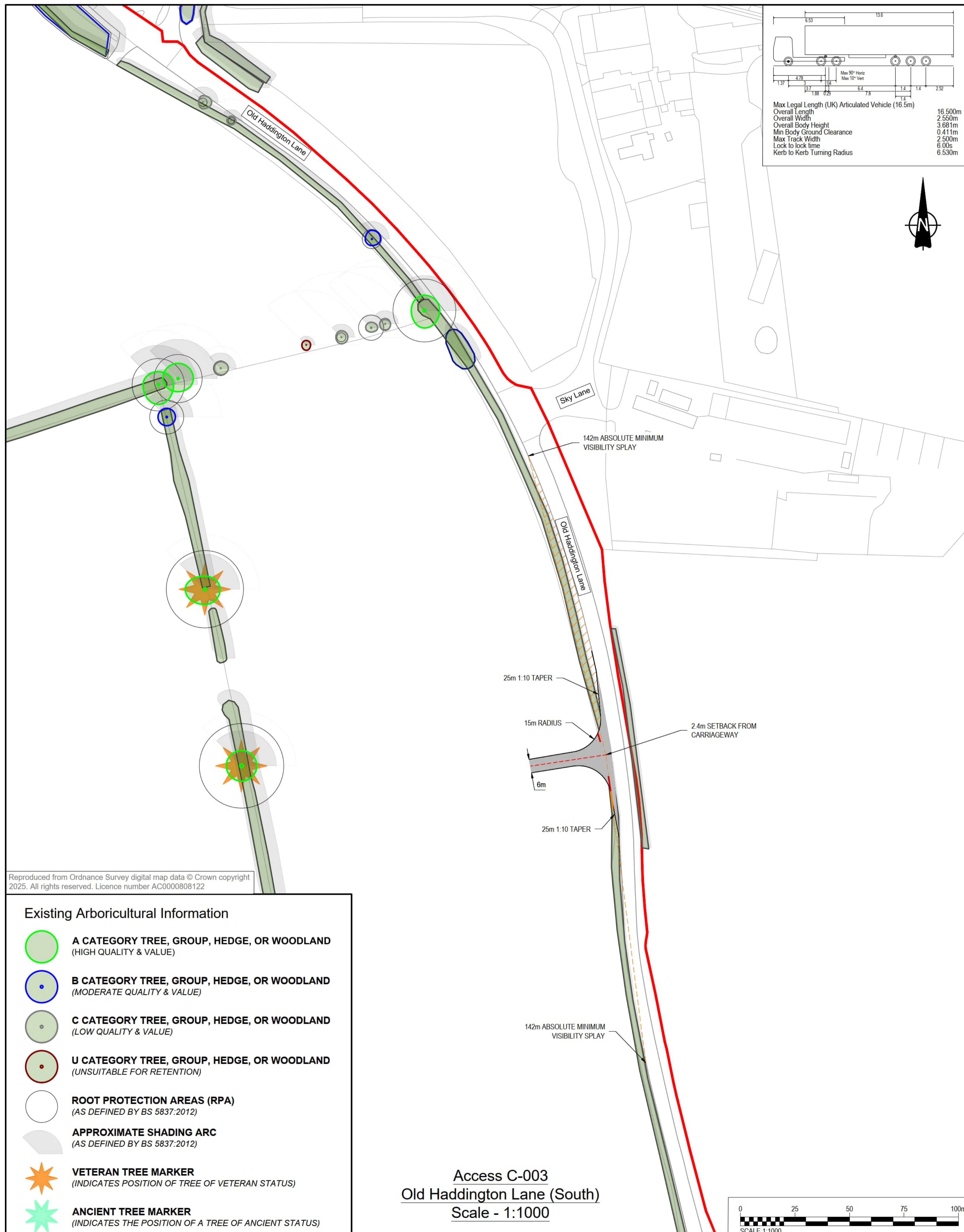

Reproduced from Ordnance Survey digital map data © Crown copyright 2025. All rights reserved. Licence number AC0000808122

### Existing Arboricultural Information

- A CATEGORY TREE, GROUP, HEDGE, OR WOODLAND**  
(HIGH QUALITY & VALUE)
- B CATEGORY TREE, GROUP, HEDGE, OR WOODLAND**  
(MODERATE QUALITY & VALUE)
- C CATEGORY TREE, GROUP, HEDGE, OR WOODLAND**  
(LOW QUALITY & VALUE)
- U CATEGORY TREE, GROUP, HEDGE, OR WOODLAND**  
(UNSUITABLE FOR RETENTION)
- ROOT PROTECTION AREAS (RPA)**  
(AS DEFINED BY BS 5837:2012)
- APPROXIMATE SHADING ARC**  
(AS DEFINED BY BS 5837:2012)
- VETERAN TREE MARKER**  
(INDICATES POSITION OF TREE OF VETERAN STATUS)
- ANCIENT TREE MARKER**  
(INDICATES THE POSITION OF A TREE OF ANCIENT STATUS)

Access C-003  
 Old Haddington Lane (South)  
 Scale - 1:1000

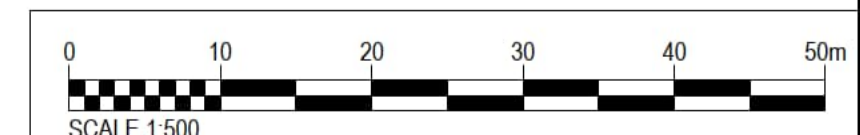
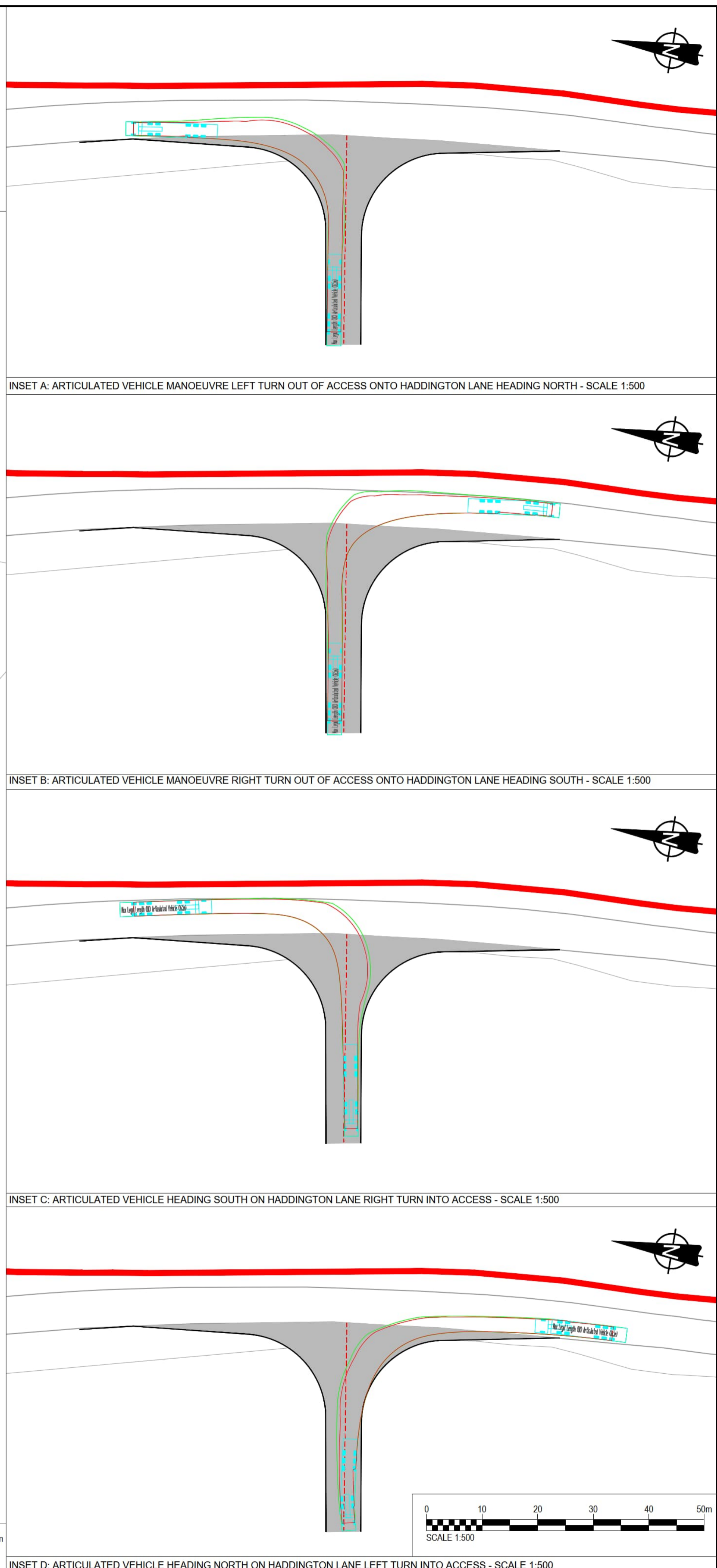
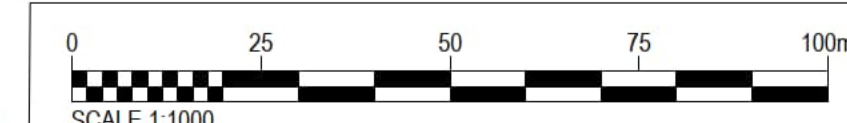

This drawing has been prepared for the use of AECOM's client. It may not be used, modified, reproduced or relied upon by third parties, except as agreed by AECOM or as required by law. AECOM accepts no responsibility, and denies any liability whatsoever, to any party that uses or relies on this drawing without AECOM's express written consent. Do not scale this document.

**PROJECT**  
 Fosse Green Energy

**CLIENT**  
 Fosse Green Energy Ltd

**CONSULTANT**  
 AECOM

**NOTES**

- This drawing is to be read in conjunction with all other relevant documentation.
- Do not scale from this drawing, use only printed dimensions.
- All dimensions in meters, all chainages, levels and coordinates are in meters unless defined otherwise.
- This drawing is to be read in conjunction with the project Health & Safety File for any identified potential risks.
- Vegetation to be removed denotes any vegetation features (such as hedgerows) that need to be removed to provide the required junction visibility. Any verge grassland is not to be removed but managed by the relevant maintainer to a low height so as to not impact upon junction visibility.
- Vehicle tracking shown is indicative only, and represents approximate vehicle size & arrangement for the design vehicle shown.
- Junction visibility for the access is based upon visibility parameters derived using 85th Percentile Speed Survey Data received on 1st December 2023.
- These plans should also be read in conjunction with ES Volume 6.2 Appendix 10-H Arboricultural Impact Assessment, for details on hedgerow removal and tree protection

**LEGEND**

- Extent of Access Footprint
- DCO Site Boundary
- Existing Public Rights of Way
- Vehicle body
- Vehicle body path
- Vehicle load
- Vehicle load path
- Vehicle wheels path
- Edge of road
- Land not included in the DCO Site Boundary
- Junction Visibility Absolute Min.
- Junction Visibility DMRB Min.
- Vegetation to be removed DMRB Min. Vis Splay
- Indicative Hedgerow Removal Absolute Min. Vis Splay
- Indicative Hedgerow Removal for Bellmouth Access
- Approximate Structure Footprint
- Health and Safety Risk Identifier

**SHEET PLAN**

**ISSUE/REVISION**

NO.	DATE	DESCRIPTION
P01	17/07/2025	DCO SUBMISSION

**LEGISLATION**  
 Regulation 5(2)(k) Infrastructure Planning (Applications: Prescribed Forms and Procedure) Regulations 2009

**ISSUE PURPOSE**  
 DCO SUBMISSION

**FIGURE TITLE**      **REV.**

ACCESS C-003      01

**DOCUMENT REFERENCE**  
 EN010154/APP/7.18

ISO A1 594mm x 841mm  
 Project No.: 60700987  
 Drawn: GT  
 Checked: MEK  
 Approved: JH  
 Date: 17/07/2025  
 Last saved by: TOBIN/G/2025/07-17  
 Last Plotter: 2025-07-17  
 Filename: C:\USER\STAYLOR\AECOM\FOSSE GREEN ENERGY PROJECT (AECOM) - GENERAL\900\_CAD\_GIS\913\_HIGHWAYS\DRAWINGS (CAD)\ACCESS DRAWINGS DCO\60700987-ACM-HGN-DR-CH-0004.DWG

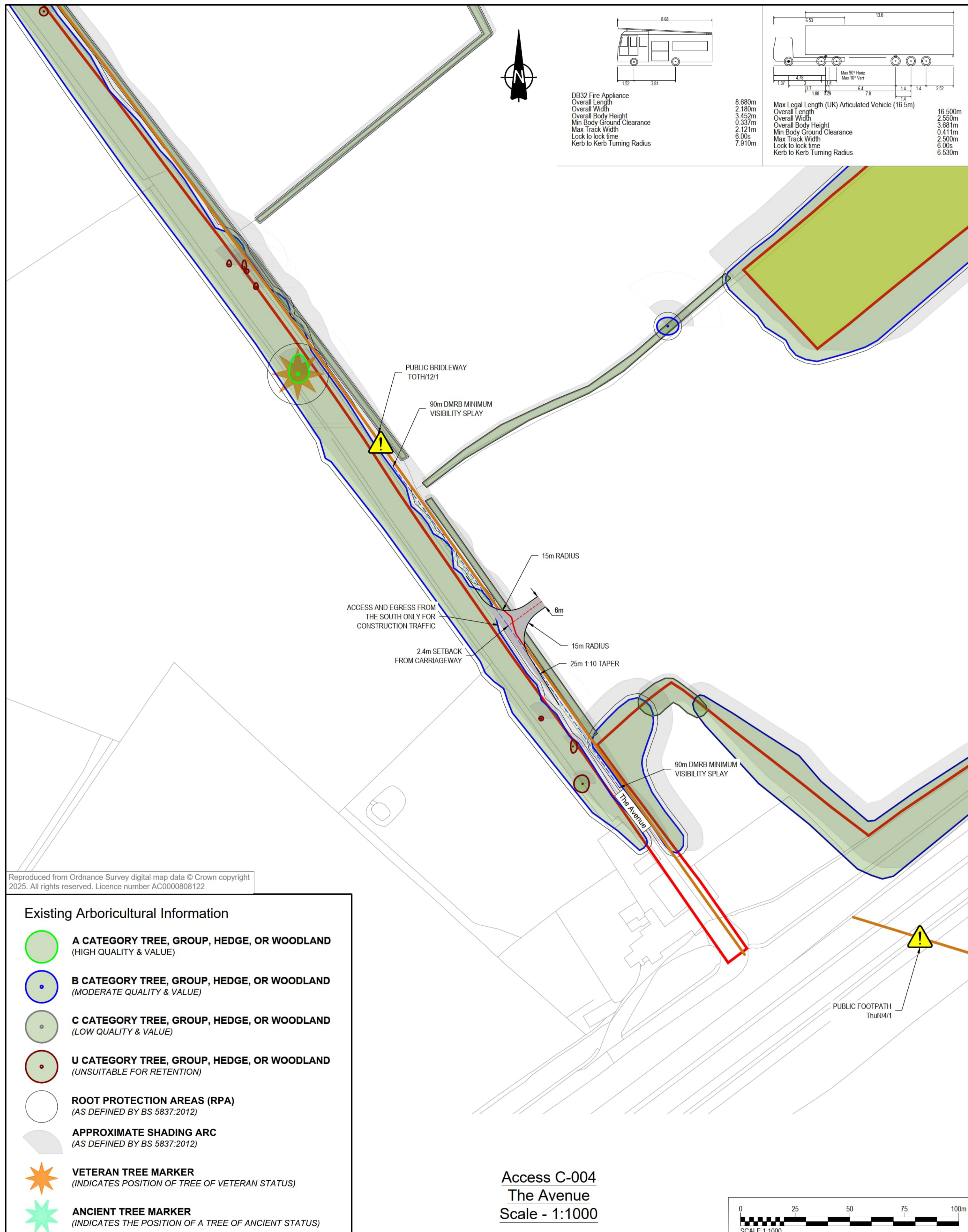

Reproduced from Ordnance Survey digital map data © Crown copyright 2025. All rights reserved. Licence number AC0000808122

**Existing Arboricultural Information**

- A CATEGORY TREE, GROUP, HEDGE, OR WOODLAND** (HIGH QUALITY & VALUE)
- B CATEGORY TREE, GROUP, HEDGE, OR WOODLAND** (MODERATE QUALITY & VALUE)
- C CATEGORY TREE, GROUP, HEDGE, OR WOODLAND** (LOW QUALITY & VALUE)
- U CATEGORY TREE, GROUP, HEDGE, OR WOODLAND** (UNSUITABLE FOR RETENTION)
- ROOT PROTECTION AREAS (RPA)** (AS DEFINED BY BS 5837:2012)
- APPROXIMATE SHADING ARC** (AS DEFINED BY BS 5837:2012)
- VETERAN TREE MARKER** (INDICATES POSITION OF TREE OF VETERAN STATUS)
- ANCIENT TREE MARKER** (INDICATES THE POSITION OF A TREE OF ANCIENT STATUS)

EGRESS MOVEMENTS TO BE BANKSPERSON CONTROLLED TO ENSURE THAT NO EGRESS MOVEMENT IS UNDERTAKEN AT THE SAME TIME AS ARRIVING CONSTRUCTION TRAFFIC.

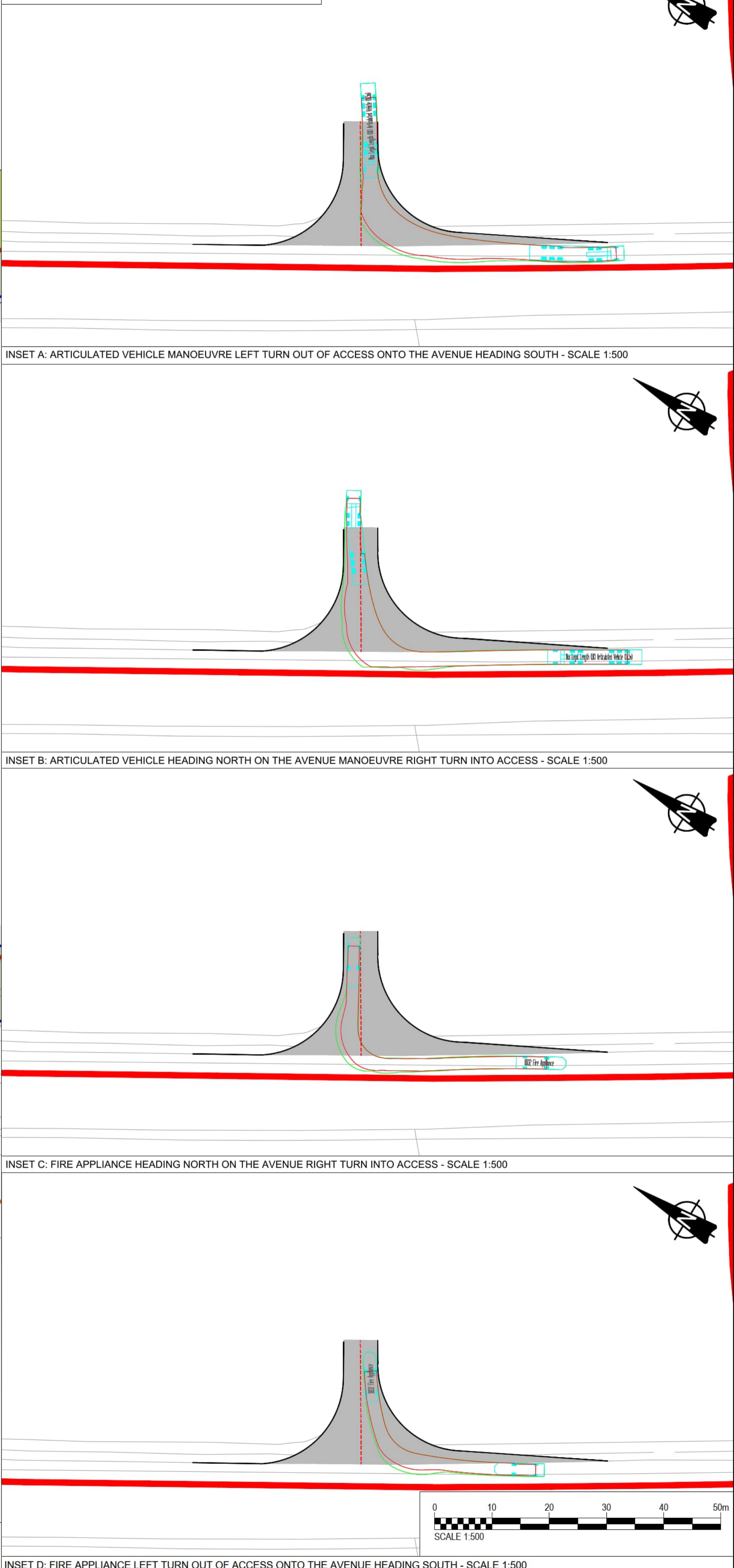

**PROJECT**  
 Fosse Green Energy

**CLIENT**  
 Fosse Green Energy Ltd

**CONSULTANT**  
 AECOM

- NOTES**
- This drawing is to be read in conjunction with all other relevant documentation.
  - Do not scale from this drawing, use only printed dimensions.
  - All dimensions in meters, all chainages, levels and coordinates are in meters unless defined otherwise.
  - This drawing is to be read in conjunction with the project Health & Safety File for any identified potential risks.
  - Vegetation to be removed denotes any vegetation features (such as hedgerows) that need to be removed to provide the required junction visibility. Any verge grassland is not to be removed but managed by the relevant maintainer to a low height so as to not impact upon junction visibility.
  - Vehicle tracking shown is indicative only, and represents approximate vehicle size & arrangement for the design vehicle shown.
  - Junction Visibility for the access is based upon DMRB CD109 Table 2.10.
  - These plans should also be read in conjunction with ES Volume 6.2 Appendix 10-H Arboricultural Impact Assessment, for details on hedgerow removal and tree protection

- LEGEND**
- Extent of Access Footprint
  - DCO Site Boundary
  - Existing Public Rights of Way
  - Vehicle body
  - Vehicle body path
  - Vehicle load
  - Vehicle load path
  - Vehicle wheels path
  - Edge of road
  - Land not included in the DCO Site Boundary
  - Junction Visibility Absolute Min.
  - Vegetation to be removed Absolute Min. Vis Splay
  - Junction Visibility DMRB Min.
  - Vegetation to be removed DMRB Min. Vis Splay
  - Indicative Hedgerow Removal Absolute Min. Vis Splay
  - Indicative Hedgerow Removal for Bellmouth Access
  - Approximate Structure Footprint
  - Health and Safety Risk Identifier



**ISSUE/REVISION**

NO	DATE	DESCRIPTION
P01	17/07/2025	DCO SUBMISSION

**LEGISLATION**  
 Regulation 5(2)(k) Infrastructure Planning (Applications: Prescribed Forms and Procedure) Regulations 2009

**ISSUE PURPOSE**  
 DCO SUBMISSION

FIGURE TITLE	REV.
ACCESS C-004	01

**DOCUMENT REFERENCE**  
 EN10154/APP/7.18

This drawing has been prepared for the use of AECOM's client. It may not be used, modified, reproduced or relied upon by third parties, except as agreed by AECOM, or as required by law. AECOM accepts no responsibility, and denies any liability whatsoever, to any party that uses or relies on this drawing without AECOM's express written consent. Do not scale this document.

- NOTES**
- This drawing is to be read in conjunction with all other relevant documentation.
  - Do not scale from this drawing, use only printed dimensions.
  - All dimensions in meters, all chainages, levels and coordinates are in meters unless defined otherwise.
  - This drawing is to be read in conjunction with the project Health & Safety File for any identified potential risks.
  - Vegetation to be removed denotes any vegetation features (such as hedgerows) that need to be removed to provide the required junction visibility. Any verge grassland is not to be removed but managed by the relevant maintainer to a low height so as to not impact upon junction visibility.
  - Vehicle tracking shown is indicative only, and represents approximate vehicle size & arrangement for the design vehicle shown.
  - Junction Visibility for the access is based upon DMRB CD109 Table 2.10.
  - These plans should also be read in conjunction with ES Volume 6.2 Appendix 10-H Arboricultural Impact Assessment, for details on hedgerow removal and tree protection.

- LEGEND**
- Extent of Access Footprint
  - DCO Site Boundary
  - Existing Public Rights of Way
  - Vehicle body
  - Vehicle body path
  - Vehicle load
  - Vehicle load path
  - Vehicle wheels path
  - Edge of road
  - Land not included in the DCO Site Boundary
  - Junction Visibility Absolute Min.
  - Vegetation to be removed Absolute Min. Vis Splay
  - Junction Visibility DMRB Min.
  - Vegetation to be removed DMRB Min. Vis Splay
  - Indicative Hedgerow Removal Absolute Min. Vis Splay
  - Indicative Hedgerow Removal for Bellmouth Access
  - Approximate Structure Footprint
  - Health and Safety Risk Identifier

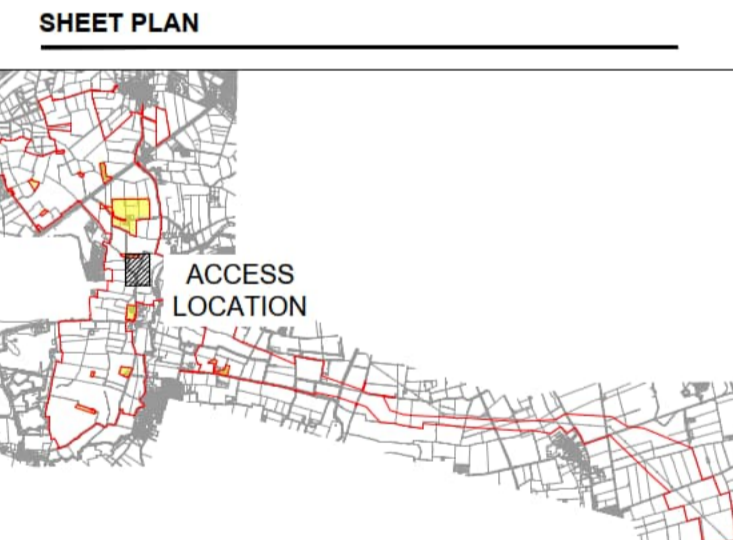

**ISSUE/REVISION**

NO.	DATE	DESCRIPTION
P01	17/07/2025	DCO SUBMISSION

**LEGISLATION**  
Regulation 5(2)(k) Infrastructure Planning (Applications: Prescribed Forms and Procedure) Regulations 2009

**ISSUE PURPOSE**  
DCO SUBMISSION

FIGURE TITLE	REV.
ACCESS C-005	01

**DOCUMENT REFERENCE**  
EN010154/APP/7.18

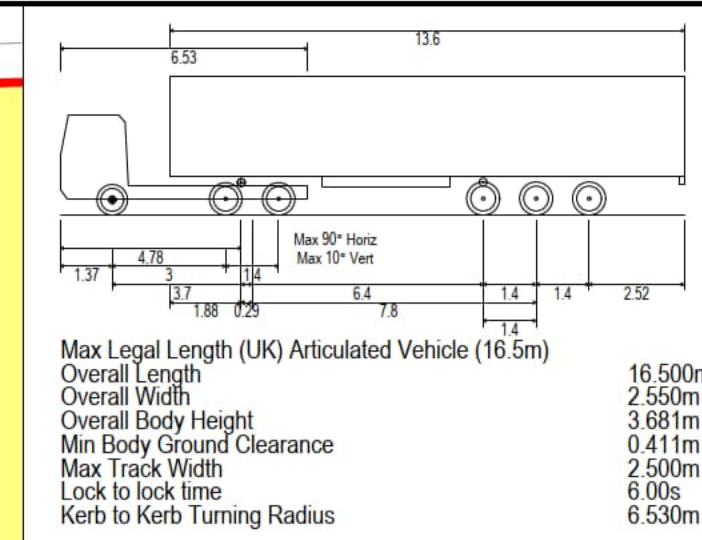
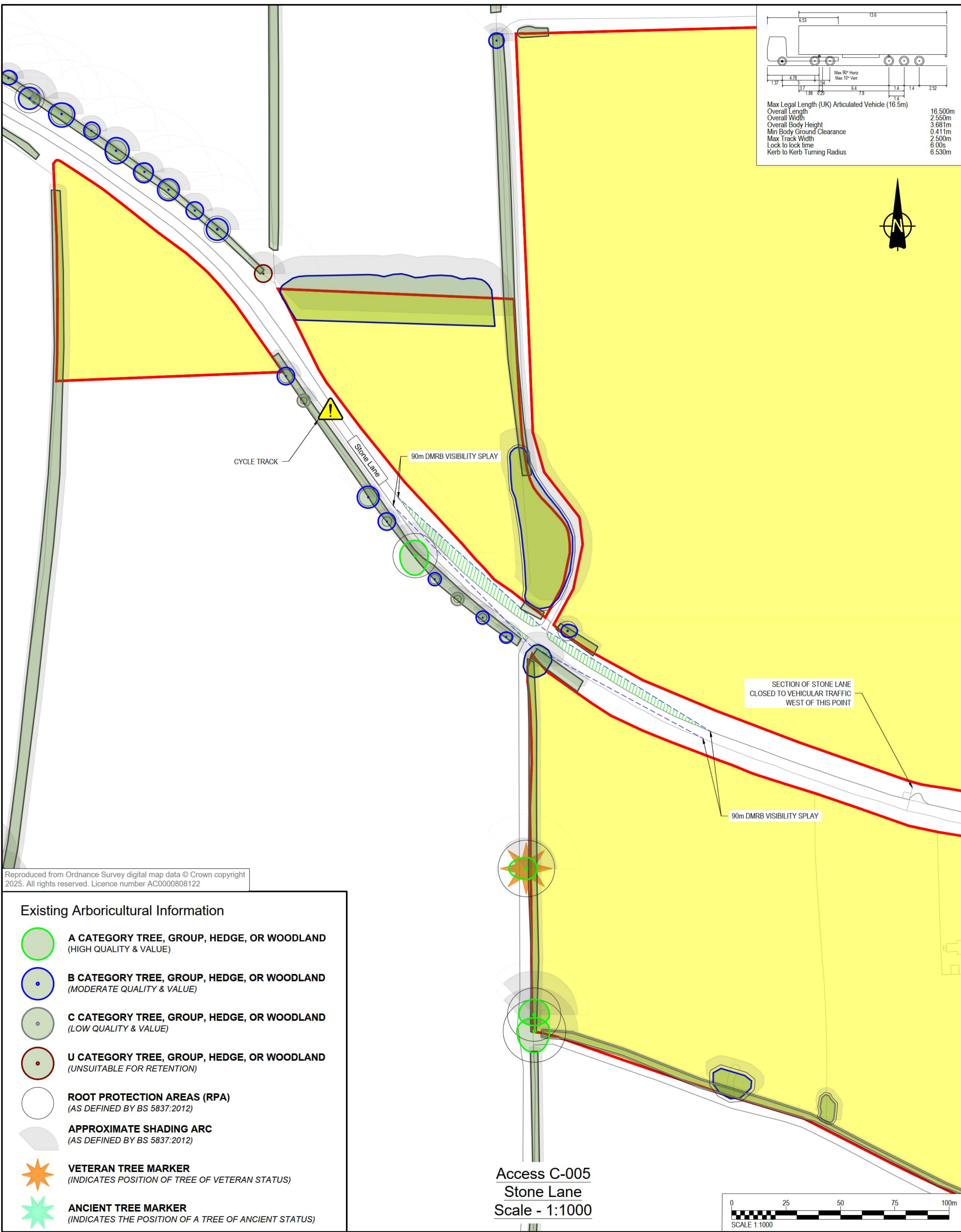

EGRESS MOVEMENTS TO BE BANKSPERSON CONTROLLED TO ENSURE THAT NO EGRESS MOVEMENT IS UNDERTAKEN AT THE SAME TIME AS ARRIVING CONSTRUCTION TRAFFIC.

INSET A: ARTICULATED VEHICLE CROSSING STONE LANE HEADING SOUTH - SCALE 1:500

INSET B: ARTICULATED VEHICLE CROSSING STONE LANE HEADING NORTH - SCALE 1:500

Reproduced from Ordnance Survey digital map data © Crown copyright 2025. All rights reserved. Licence number AC0000808122

**Existing Arboricultural Information**

- A CATEGORY TREE, GROUP, HEDGE, OR WOODLAND**  
(HIGH QUALITY & VALUE)
- B CATEGORY TREE, GROUP, HEDGE, OR WOODLAND**  
(MODERATE QUALITY & VALUE)
- C CATEGORY TREE, GROUP, HEDGE, OR WOODLAND**  
(LOW QUALITY & VALUE)
- U CATEGORY TREE, GROUP, HEDGE, OR WOODLAND**  
(UNSUITABLE FOR RETENTION)
- ROOT PROTECTION AREAS (RPA)**  
(AS DEFINED BY BS 5837:2012)
- APPROXIMATE SHADING ARC**  
(AS DEFINED BY BS 5837:2012)
- VETERAN TREE MARKER**  
(INDICATES POSITION OF TREE OF VETERAN STATUS)
- ANCIENT TREE MARKER**  
(INDICATES THE POSITION OF A TREE OF ANCIENT STATUS)

This drawing has been prepared for the use of AECOM's client. It may not be used, modified, reproduced or relied upon by third parties, except as agreed by AECOM or as required by law. AECOM accepts no responsibility, and denies any liability whatsoever, to any party that uses or relies on this drawing without AECOM's express written consent. Do not scale this document.

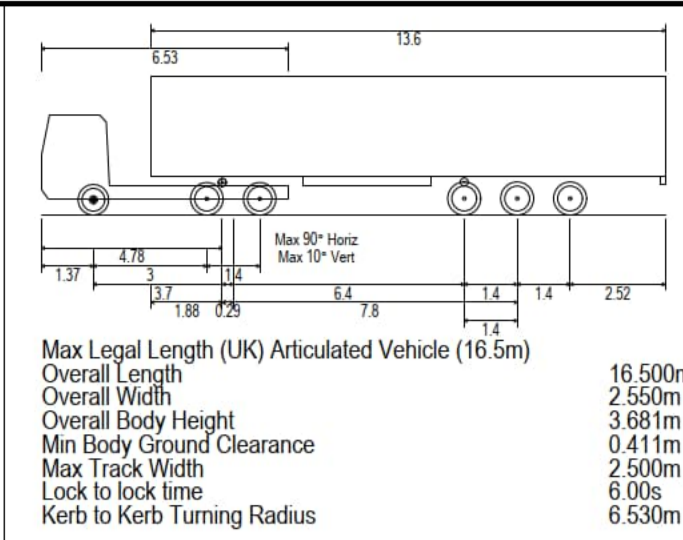
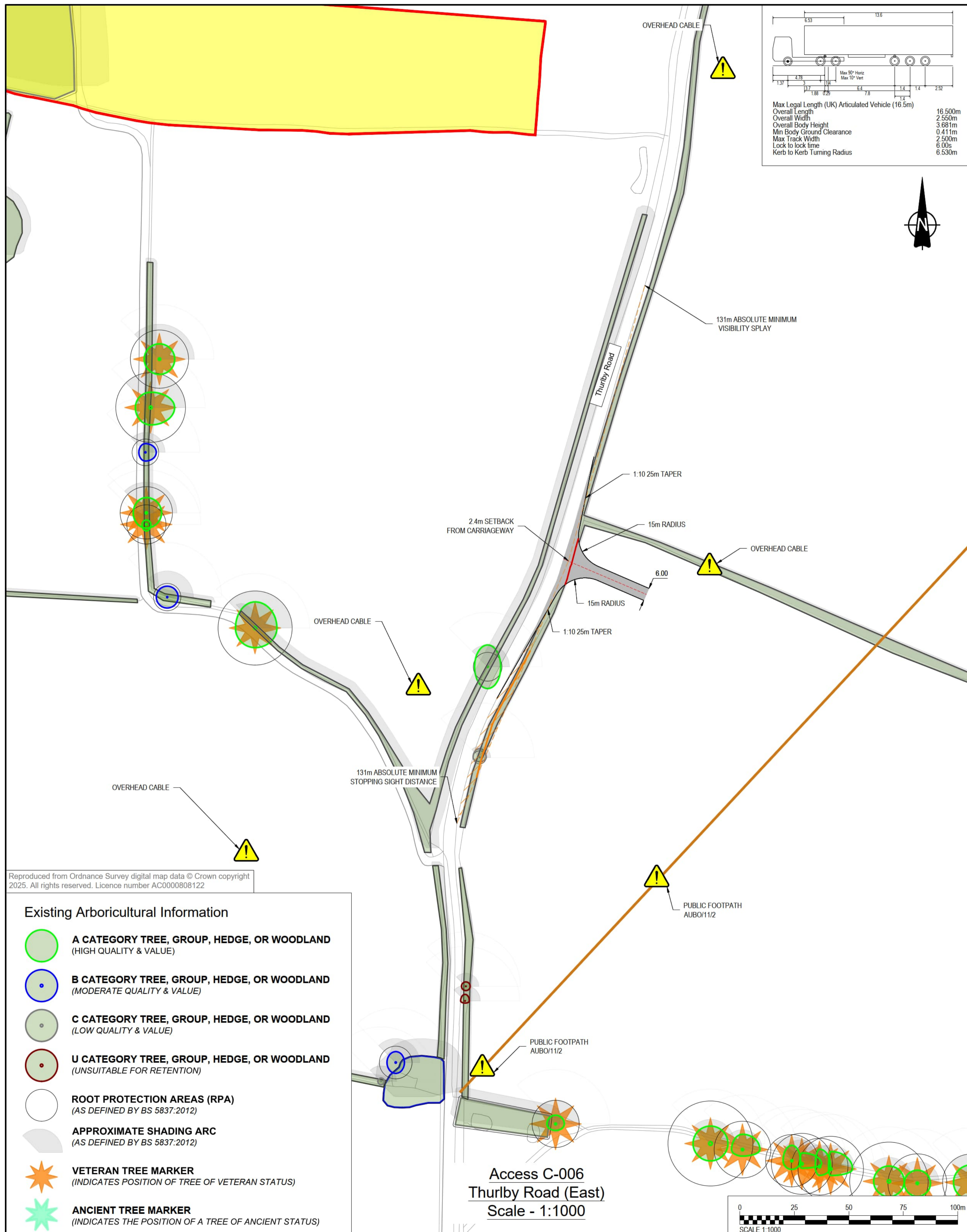

EGRESS MOVEMENTS TO BE BANKSPERSON CONTROLLED TO ENSURE THAT NO EGRESS MOVEMENT IS UNDERTAKEN AT THE SAME TIME AS ARRIVING CONSTRUCTION TRAFFIC.

INSET A: ARTICULATED VEHICLE LEFT TURN ONTO HADDINGTON LANE HEADING SOUTH - SCALE 1:500

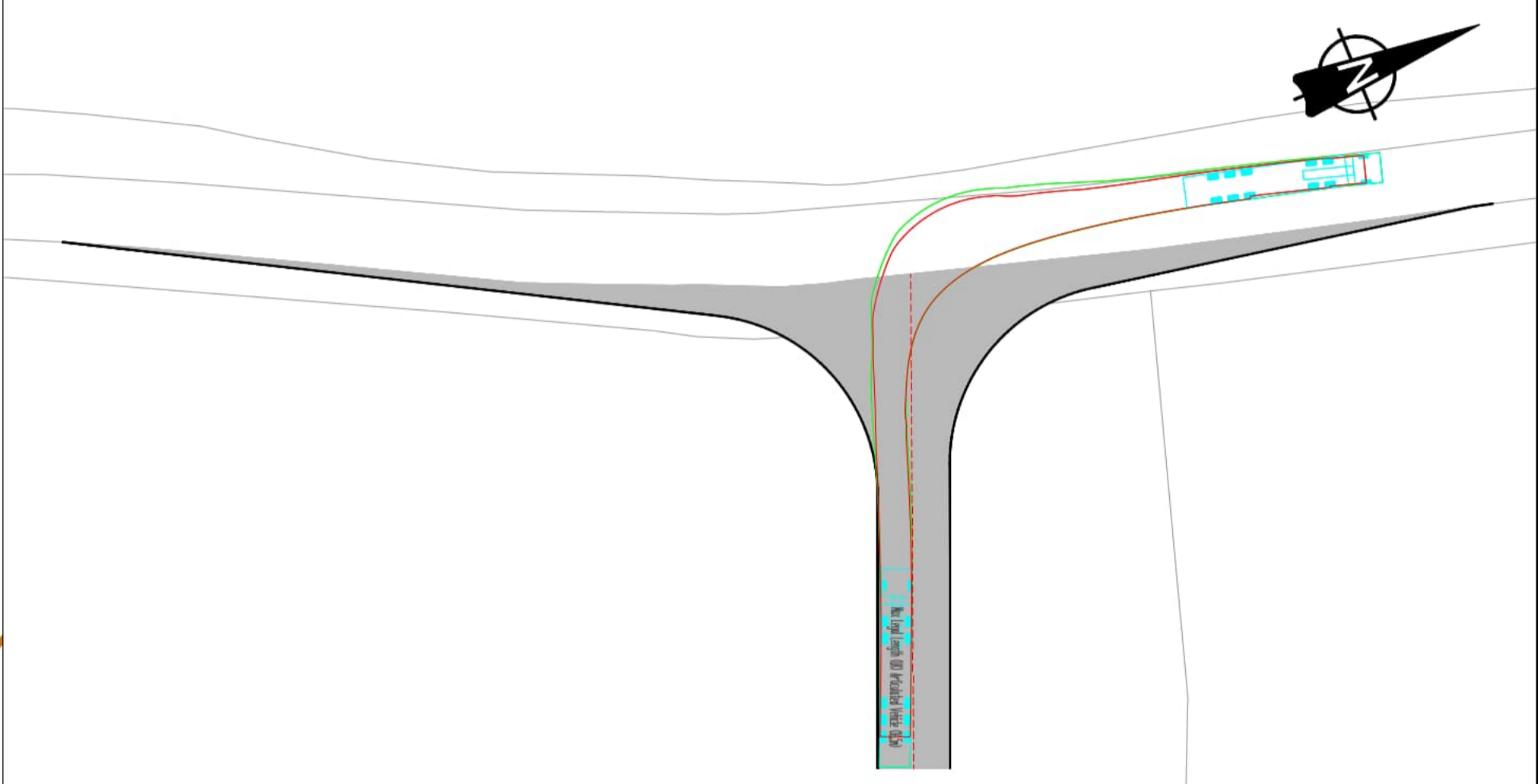

INSET B: ARTICULATED VEHICLE RIGHT TURN ONTO HADDINGTON LANE HEADING NORTH - SCALE 1:500

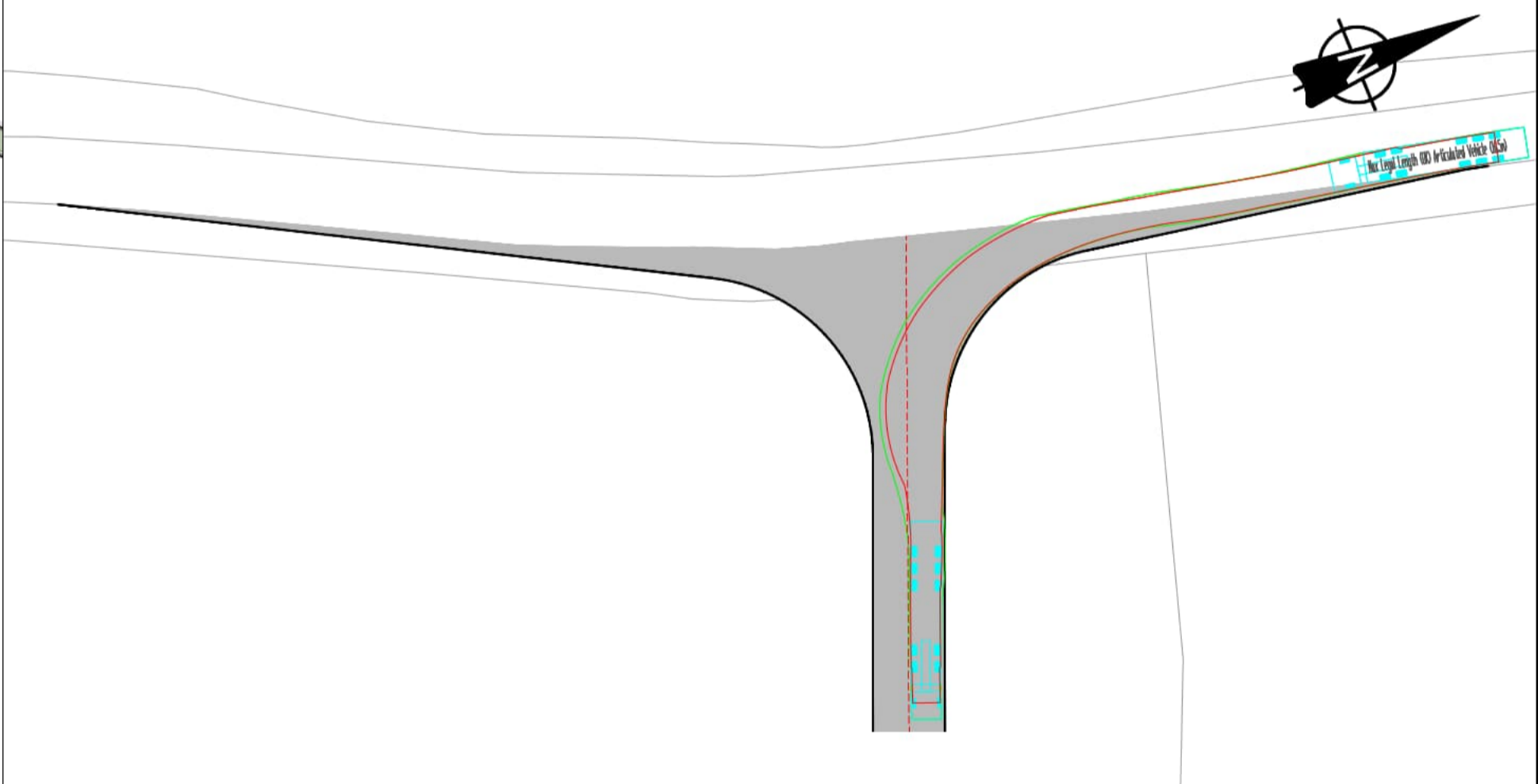

INSET C: ARTICULATED VEHICLE HEADING SOUTH ON HADDINGTON LANE LEFT TURN INTO ACCESS - SCALE 1:500

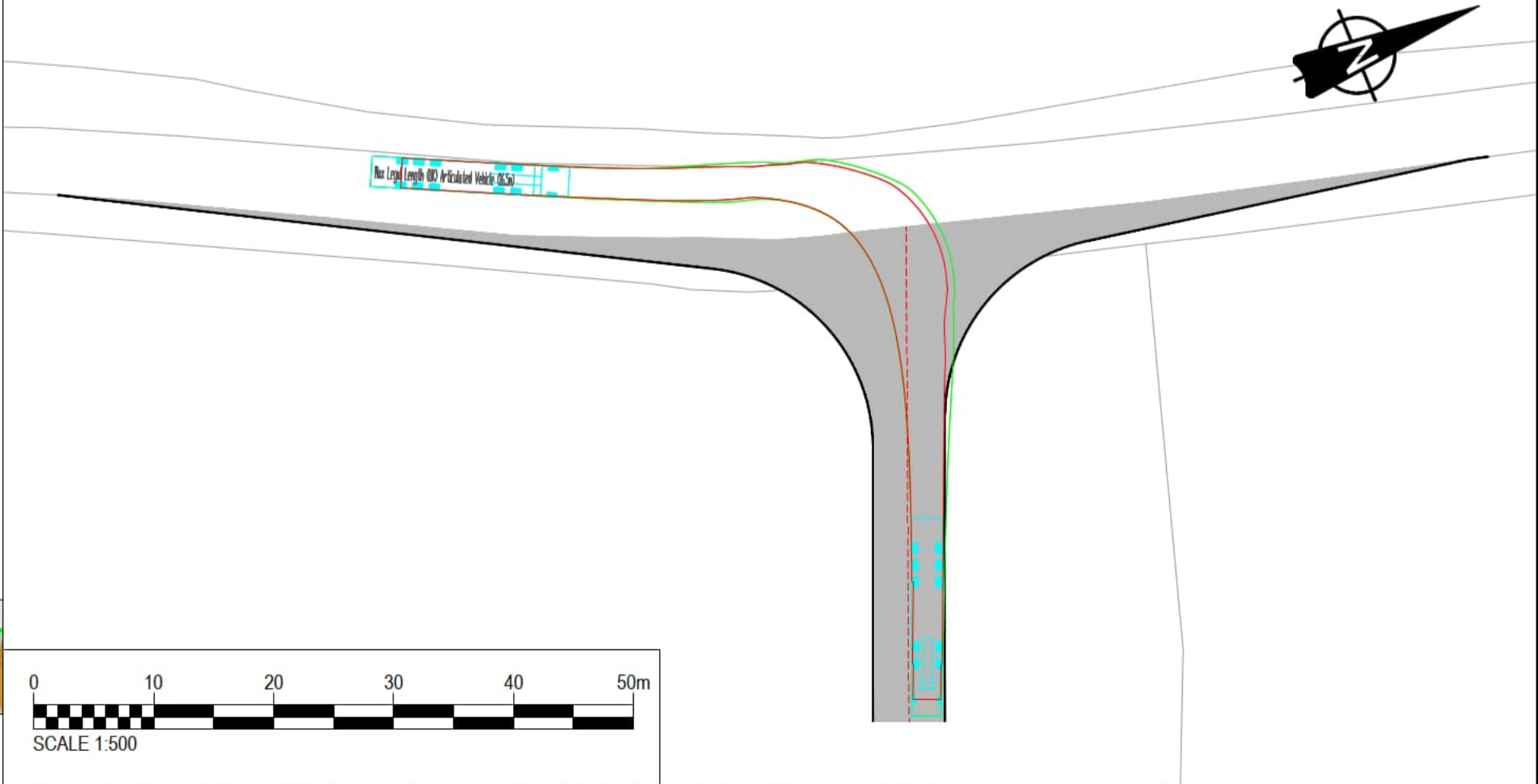

INSET D: ARTICULATED VEHICLE HEADING NORTH ON HADDINGTON LANE RIGHT TURN INTO ACCESS - SCALE 1:500

This drawing has been prepared for the use of AECOM's client. It may not be used, modified, reproduced or relied upon by third parties, except as agreed by AECOM or as required by law. AECOM accepts no responsibility, and denies any liability whatsoever, to any party that uses or relies on this drawing without AECOM's express written consent. Do not scale this document.



**PROJECT**  
 Fosse Green Energy

**CLIENT**  
 Fosse Green Energy Ltd

**CONSULTANT**  
 AECOM

- NOTES**
- This drawing is to be read in conjunction with all other relevant documentation.
  - Do not scale from this drawing, use only printed dimensions.
  - All dimensions in meters, all chainages, levels and coordinates are in meters unless defined otherwise.
  - This drawing is to be read in conjunction with the project Health & Safety File for any identified potential risks.
  - Vegetation to be removed denotes any vegetation features (such as hedgerows) that need to be removed to provide the required junction visibility. Any verge grassland is not to be removed but managed by the relevant maintainer to a low height so as to not impact upon junction visibility.
  - Vehicle tracking shown is indicative only, and represents approximate vehicle size & arrangement for the design vehicle shown.
  - Junction visibility for the access is based upon visibility parameters derived using 85th Percentile Speed Survey Data received on 1st December 2023.
  - These plans should also be read in conjunction with ES Volume 6.2 Appendix 10-H Arboricultural Impact Assessment, for details on hedgerow removal and tree protection

- LEGEND**
- Extent of Access Footprint
  - DCO Site Boundary
  - Existing Public Rights of Way
  - Vehicle body
  - Vehicle body path
  - Vehicle load
  - Vehicle load path
  - Vehicle wheels path
  - Edge of road
  - Land not included in the DCO Site Boundary
  - Junction Visibility Absolute Min.
  - Vegetation to be removed Absolute Min. Vis Splay
  - Junction Visibility DMRB Min.
  - Vegetation to be removed DMRB Min. Vis Splay
  - Indicative Hedgerow Removal Absolute Min. Vis Splay
  - Indicative Hedgerow Removal for Bellmouth Access
  - Approximate Structure Footprint
  - Health and Safety Risk Identifier

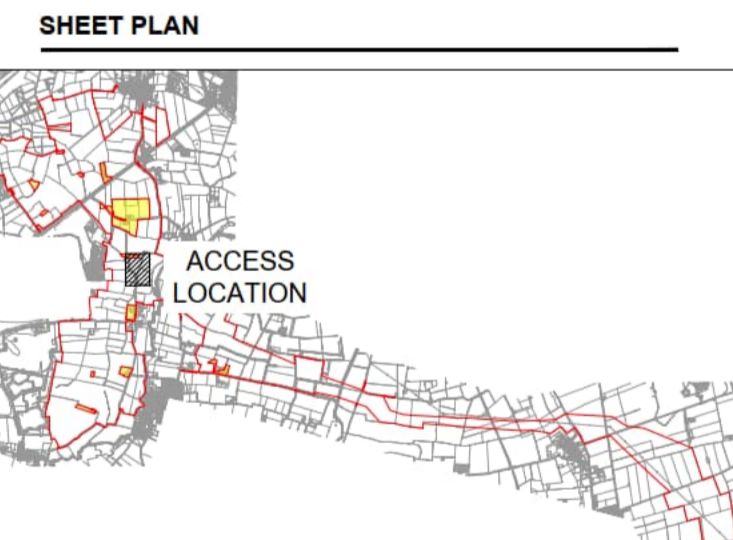

**ISSUE/REVISION**

NO.	DATE	DESCRIPTION
P01	17/07/2025	DCO SUBMISSION

**LEGISLATION**  
 Regulation 5(2)(k) Infrastructure Planning (Applications: Prescribed Forms and Procedure) Regulations 2009

**ISSUE PURPOSE**  
 DCO SUBMISSION

**FIGURE TITLE**

FIGURE TITLE	REV.
ACCESS C-006	01

**DOCUMENT REFERENCE**  
 EN10154/APP/7.18

ISO A1 594mm x 841mm  
 Project No.: 60700987  
 Drawn: GT  
 Checked: MEK  
 Approved: JH  
 Date: 17/07/2025  
 Project Name: C:\USERS\T\BING\2025-07-17 - Last Plotted: 2025-07-17  
 Filename: C:\USERS\T\BING\2025-07-17 - FOSSE GREEN ENERGY PROJECT - AECOM\900\_CAD\_GIS\913\_HIGHWAYS\DRAWINGS (CAD)\ACCESS DRAWINGS DCO\60700987-ACM-HGN-DR-CH-0007 DWG

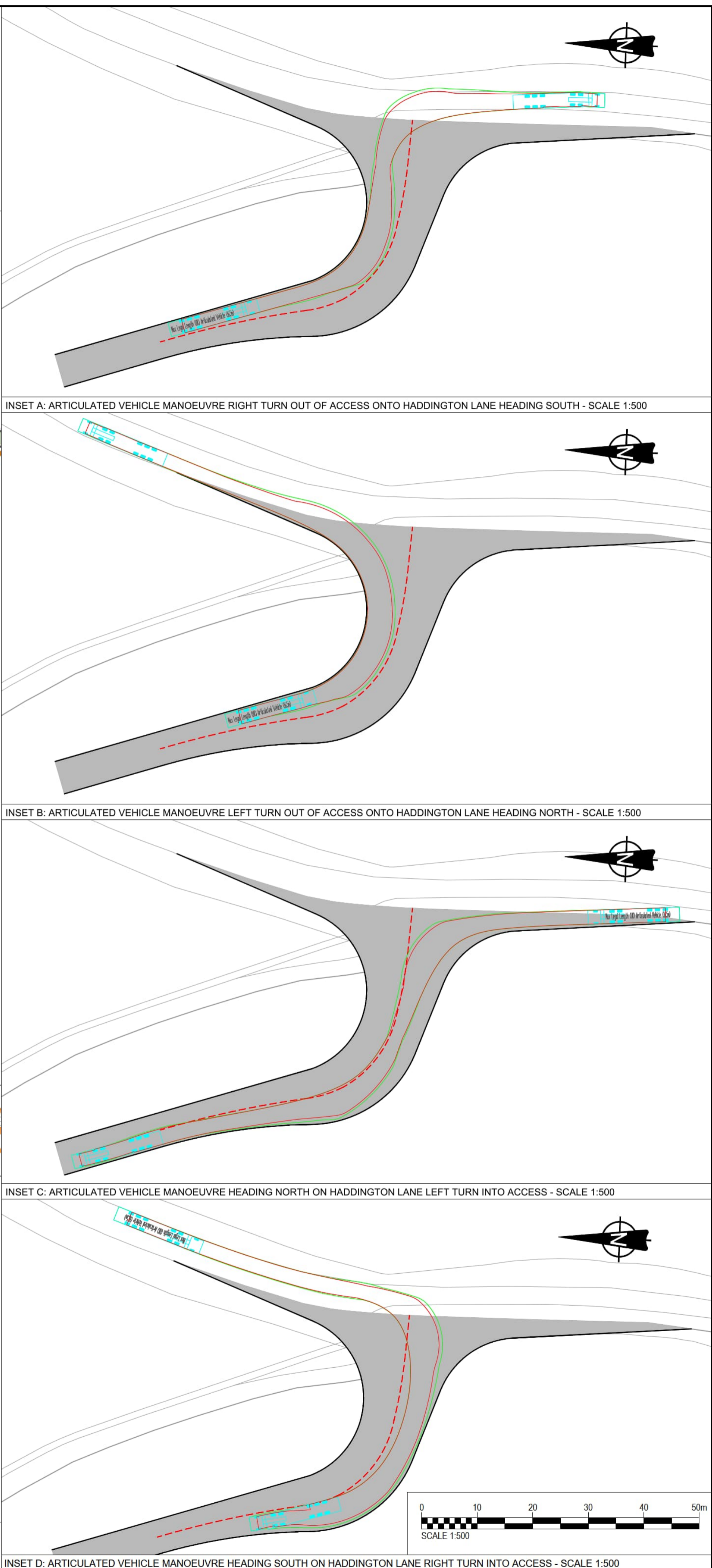
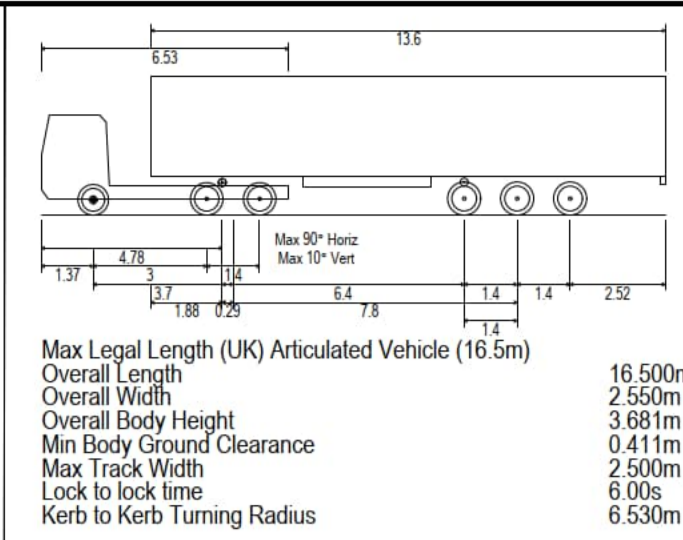
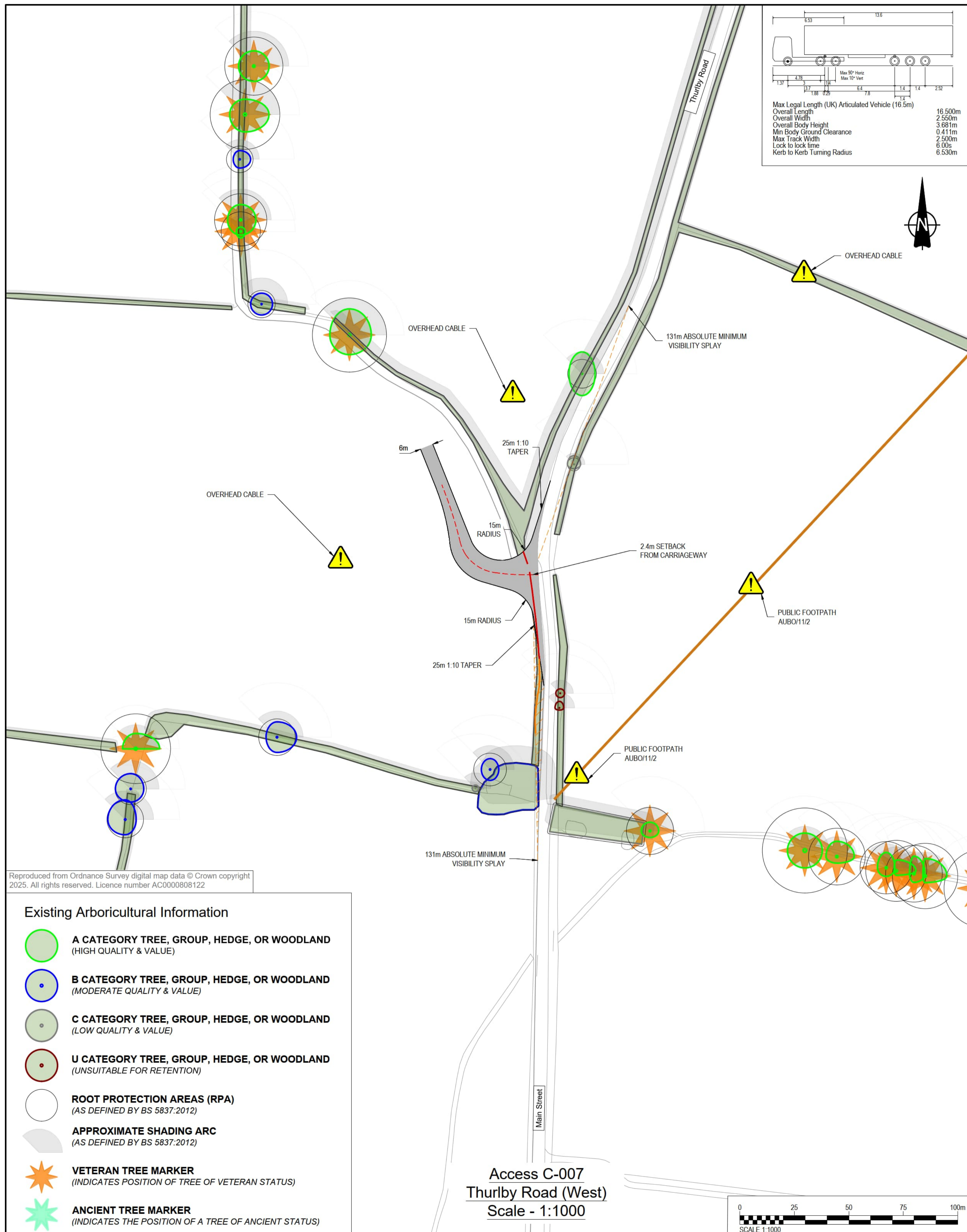

Reproduced from Ordnance Survey digital map data © Crown copyright 2025. All rights reserved. Licence number AC0000808122

### Existing Arboricultural Information

- A CATEGORY TREE, GROUP, HEDGE, OR WOODLAND**  
(HIGH QUALITY & VALUE)
- B CATEGORY TREE, GROUP, HEDGE, OR WOODLAND**  
(MODERATE QUALITY & VALUE)
- C CATEGORY TREE, GROUP, HEDGE, OR WOODLAND**  
(LOW QUALITY & VALUE)
- U CATEGORY TREE, GROUP, HEDGE, OR WOODLAND**  
(UNSUITABLE FOR RETENTION)
- ROOT PROTECTION AREAS (RPA)**  
(AS DEFINED BY BS 5837:2012)
- APPROXIMATE SHADING ARC**  
(AS DEFINED BY BS 5837:2012)
- VETERAN TREE MARKER**  
(INDICATES POSITION OF TREE OF VETERAN STATUS)
- ANCIENT TREE MARKER**  
(INDICATES THE POSITION OF A TREE OF ANCIENT STATUS)



**PROJECT**  
 Fosse Green Energy

**CLIENT**  
 Fosse Green Energy Ltd

**CONSULTANT**  
 AECOM

- NOTES**
- This drawing is to be read in conjunction with all other relevant documentation.
  - Do not scale from this drawing, use only printed dimensions.
  - All dimensions in meters, all chainages, levels and coordinates are in meters unless defined otherwise.
  - This drawing is to be read in conjunction with the project Health & Safety File for any identified potential risks.
  - Vegetation to be removed denotes any vegetation features (such as hedgerows) that need to be removed to provide the required junction visibility. Any verge grassland is not to be removed but managed by the relevant maintainer to a low height so as to not impact upon junction visibility.
  - Vehicle tracking shown is indicative only, and represents approximate vehicle size & arrangement for the design vehicle shown.
  - Junction visibility for the access is based upon visibility parameters derived using 85th Percentile Speed Survey Data received on 1st December 2023.
  - These plans should also be read in conjunction with ES Volume 6.2 Appendix 10-H Arboricultural Impact Assessment, for details on hedgerow removal and tree protection

- LEGEND**
- Extent of Access Footprint
  - DCO Site Boundary
  - Existing Public Rights of Way
  - Vehicle body
  - Vehicle body path
  - Vehicle load
  - Vehicle load path
  - Vehicle wheels path
  - Edge of road
  - Land not included in the DCO Site Boundary
  - Junction Visibility Absolute Min.
  - Junction Visibility DMRB Min.
  - Vegetation to be removed DMRB Min. Vis Splay
  - Indicative Hedgerow Removal Absolute Min. Vis Splay
  - Indicative Hedgerow Removal for Bellmouth Access
  - Approximate Structure Footprint
  - Health and Safety Risk Identifier

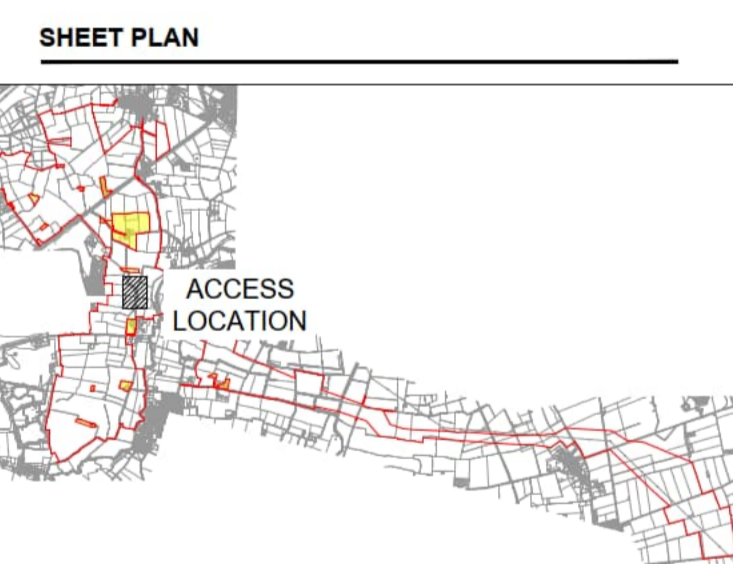

**ISSUE/REVISION**

NO.	DATE	DESCRIPTION
P01	17/07/2025	DCO SUBMISSION
I/R	DATE	DESCRIPTION

**LEGISLATION**  
 Regulation 5(2)(k) Infrastructure Planning (Applications: Prescribed Forms and Procedure) Regulations 2009

**ISSUE PURPOSE**  
 DCO SUBMISSION

FIGURE TITLE	REV.
ACCESS C-007	01

**DOCUMENT REFERENCE**  
 EN10154/APP/7.18

This drawing has been prepared for the use of AECOM's client. It may not be used, modified, reproduced or relied upon by third parties, except as agreed by AECOM or as required by law. AECOM accepts no responsibility, and denies any liability whatsoever, to any party that uses or relies on this drawing without AECOM's express written consent. Do not scale this document.

- NOTES**
- This drawing is to be read in conjunction with all other relevant documentation. Do not scale from this drawing, use only printed dimensions.
  - All dimensions in meters, all chainages, levels and coordinates are in meters unless defined otherwise.
  - This drawing is to be read in conjunction with the project Health & Safety File for any identified potential risks.
  - Vegetation to be removed denotes any vegetation features (such as hedgerows) that need to be removed to provide the required junction visibility. Any verge grassland is not to be removed but managed by the relevant maintainer to a low height so as to not impact upon junction visibility.
  - Vehicle tracking shown is indicative only, and represents approximate vehicle size & arrangement for the design vehicle shown.
  - Junction visibility for the access is based upon visibility parameters derived using 85th Percentile Speed Survey Data received on 1st December 2023.
  - These plans should also be read in conjunction with ES Volume 6.2 Appendix 10-H Arboricultural Impact Assessment, for details on hedgerow removal and tree protection

- LEGEND**
- Extent of Access Footprint
  - DCO Site Boundary
  - Existing Public Rights of Way
  - Vehicle body
  - Vehicle body path
  - Vehicle load
  - Vehicle load path
  - Vehicle wheels path
  - Edge of road
  - Land not included in the DCO Site Boundary
  - Junction Visibility Absolute Min.
  - Vegetation to be removed Absolute Min. Vis Splay
  - Junction Visibility DMRB Min.
  - Vegetation to be removed DMRB Min. Vis Splay
  - Indicative Hedgerow Removal Absolute Min. Vis Splay
  - Indicative Hedgerow Removal for Bellmouth Access
  - Approximate Structure Footprint
  - Health and Safety Risk Identifier

**SHEET PLAN**



**ISSUE/REVISION**

NO.	DATE	DESCRIPTION
P01	17/07/2025	DCO SUBMISSION
I/R	DATE	DESCRIPTION

**LEGISLATION**  
Regulation 5(2)(k) Infrastructure Planning (Applications: Prescribed Forms and Procedure) Regulations 2009

**ISSUE PURPOSE**  
DCO SUBMISSION

FIGURE TITLE	REV.
ACCESS C-008	01

**DOCUMENT REFERENCE**  
EN010154/APP/7.18

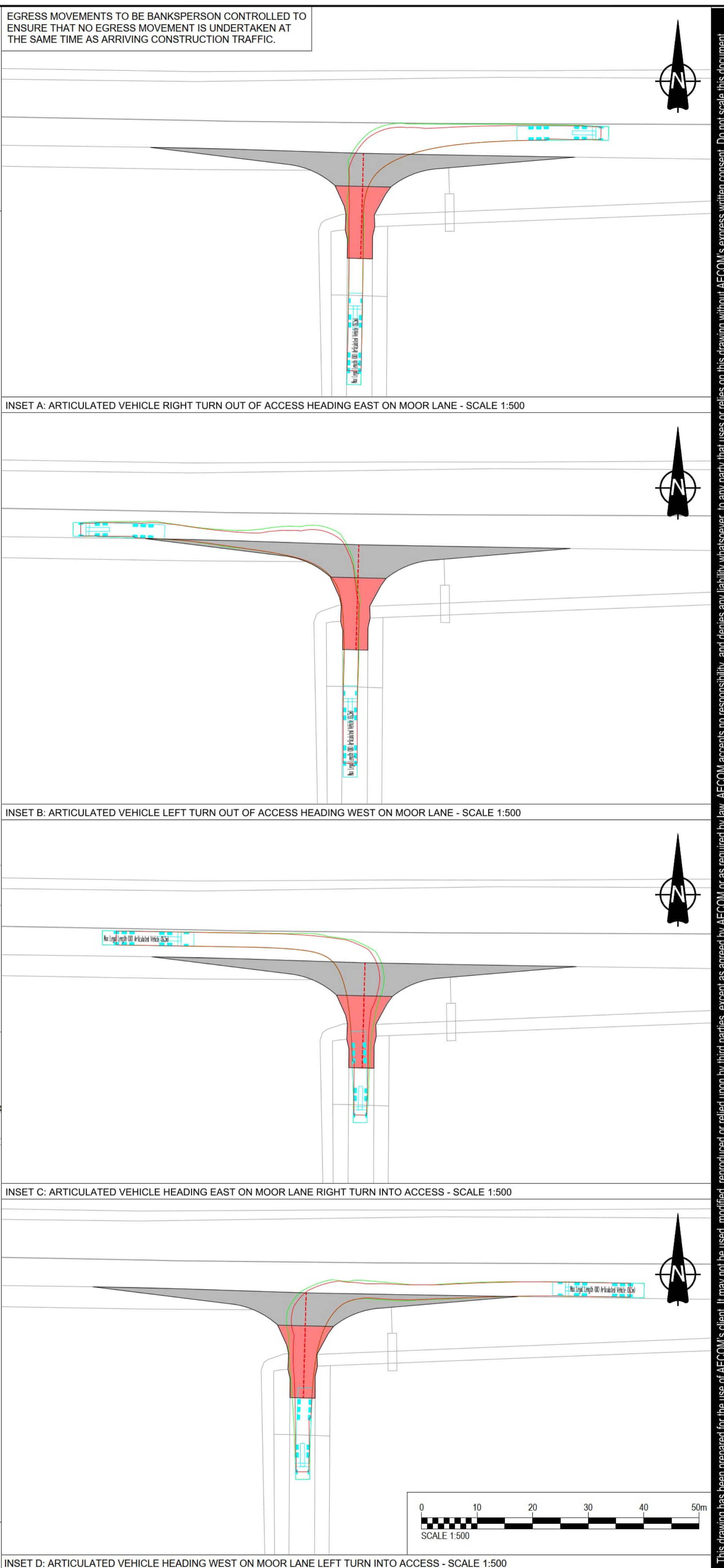
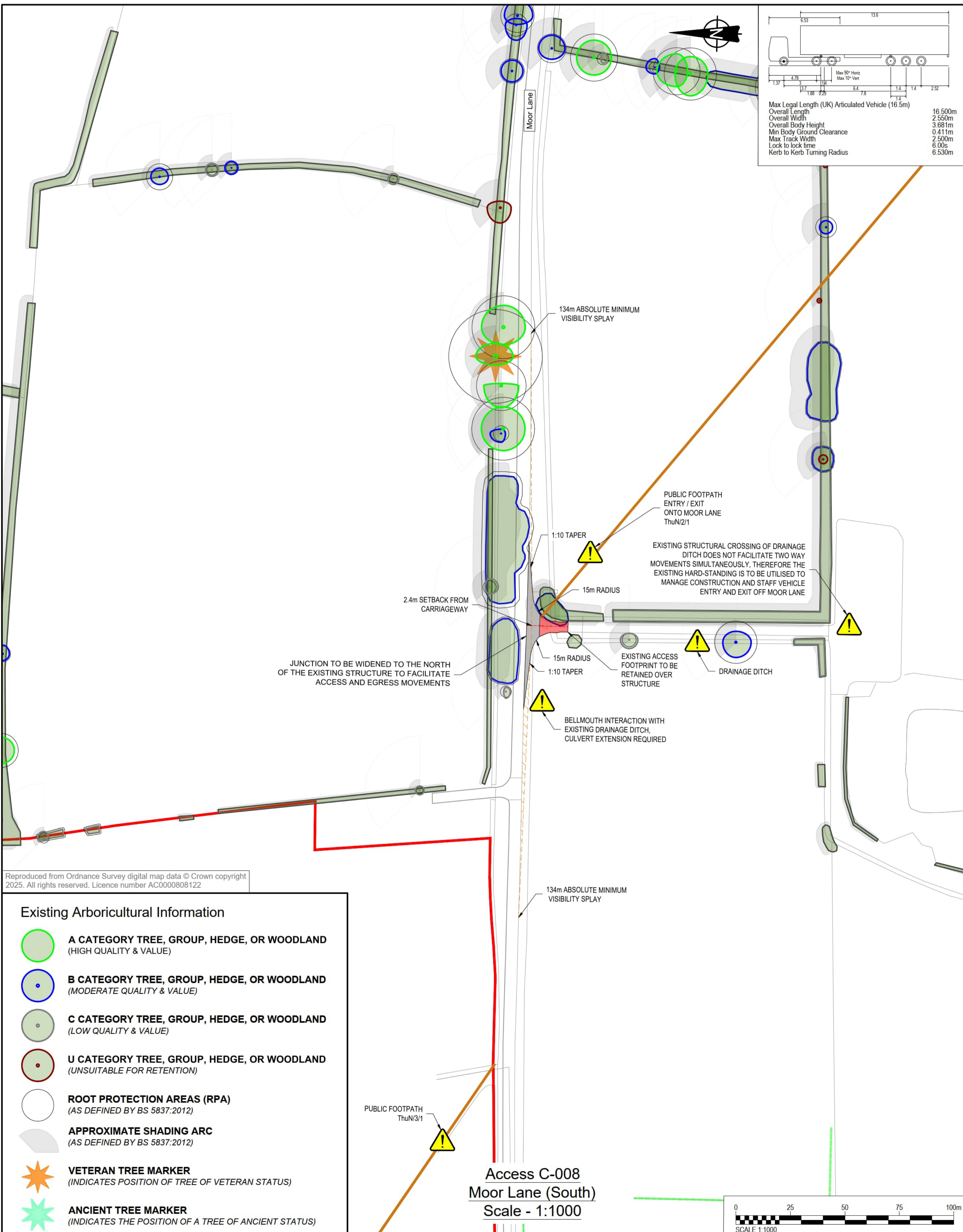

Max Legal Length (UK) Articulated Vehicle (16.5m)

Overall Length	16.500m
Overall Width	2.550m
Overall Body Height	3.681m
Min Body Ground Clearance	0.411m
Max Track Width	2.500m
Lock to lock time	6.00s
Kerb to Kerb Turning Radius	6.530m

Reproduced from Ordnance Survey digital map data © Crown copyright 2025. All rights reserved. Licence number AC0000808122

**Existing Arboricultural Information**

- **A CATEGORY TREE, GROUP, HEDGE, OR WOODLAND** (HIGH QUALITY & VALUE)
- **B CATEGORY TREE, GROUP, HEDGE, OR WOODLAND** (MODERATE QUALITY & VALUE)
- **C CATEGORY TREE, GROUP, HEDGE, OR WOODLAND** (LOW QUALITY & VALUE)
- **U CATEGORY TREE, GROUP, HEDGE, OR WOODLAND** (UNSUITABLE FOR RETENTION)
- ROOT PROTECTION AREAS (RPA)** (AS DEFINED BY BS 5837:2012)
- APPROXIMATE SHADING ARC** (AS DEFINED BY BS 5837:2012)
- ★ **VETERAN TREE MARKER** (INDICATES POSITION OF TREE OF VETERAN STATUS)
- ★ **ANCIENT TREE MARKER** (INDICATES THE POSITION OF A TREE OF ANCIENT STATUS)

This drawing has been prepared for the use of AECOM's client. It may not be used, modified, reproduced or relied upon by third parties, except as agreed by AECOM or as required by law. AECOM accepts no responsibility, and denies any liability whatsoever, to any party that uses or relies on this drawing without AECOM's express written consent. Do not scale this document.

- NOTES**
- This drawing is to be read in conjunction with all other relevant documentation.
  - Do not scale from this drawing, use only printed dimensions.
  - All dimensions in meters, all chainages, levels and coordinates are in meters unless defined otherwise.
  - This drawing is to be read in conjunction with the project Health & Safety File for any identified potential risks.
  - Vegetation to be removed denotes any vegetation features (such as hedgerows) that need to be removed to provide the required junction visibility. Any verge grassland is not to be removed but managed by the relevant maintainer to a low height so as to not impact upon junction visibility.
  - Vehicle tracking shown is indicative only, and represents approximate vehicle size & arrangement for the design vehicle shown.
  - Junction visibility for the access is based upon visibility parameters derived using 85th Percentile Speed Survey Data received on 1st December 2023.
  - These plans should also be read in conjunction with ES Volume 6.2 Appendix 10-H Arboicultural Impact Assessment, for details on hedgerow removal and tree protection.

- LEGEND**
- Extent of Access Footprint
  - DCO Site Boundary
  - Existing Public Rights of Way
  - Vehicle body
  - Vehicle body path
  - Vehicle load
  - Vehicle load path
  - Vehicle wheels path
  - Edge of road
  - Land not included in the DCO Boundary
  - Junction Visibility Absolute Min.
  - Vegetation to be removed Absolute Min. Vis Splay
  - Junction Visibility DMRB Min.
  - Vegetation to be removed DMRB Min. Vis Splay
  - Indicative Hedgerow Removal Absolute Min. Vis Splay
  - Indicative Hedgerow Removal for Bellmouth Access
  - Approximate Structure Footprint
  - Health and Safety Risk Identifier

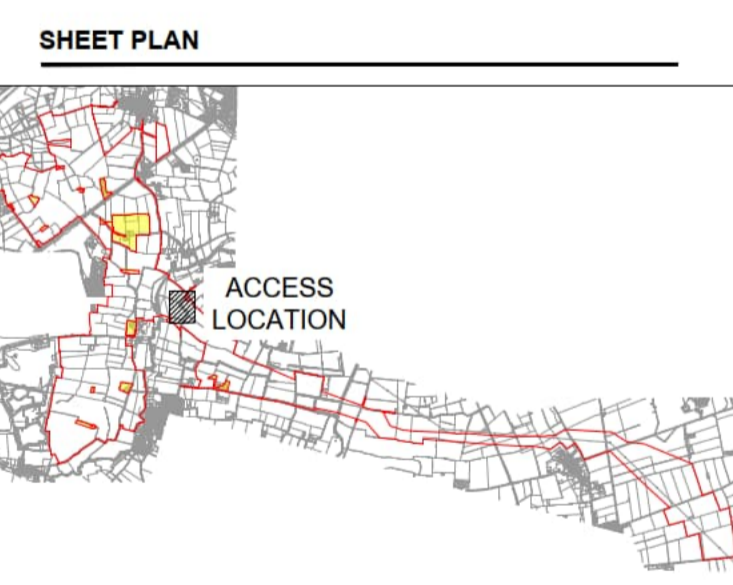

**ISSUE/REVISION**

NO.	DATE	DESCRIPTION
P01	17/07/2025	DCO SUBMISSION

**LEGISLATION**  
 Regulation 5(2)(k) Infrastructure Planning (Applications: Prescribed Forms and Procedure) Regulations 2009

**ISSUE PURPOSE**  
 DCO SUBMISSION

FIGURE TITLE	REV.
ACCESS C-009	01

**DOCUMENT REFERENCE**  
 EN010154/APP/7.18

EGRESS MOVEMENTS TO BE BANKSPERSON CONTROLLED TO ENSURE THAT NO EGRESS MOVEMENT IS UNDERTAKEN AT THE SAME TIME AS ARRIVING CONSTRUCTION TRAFFIC.

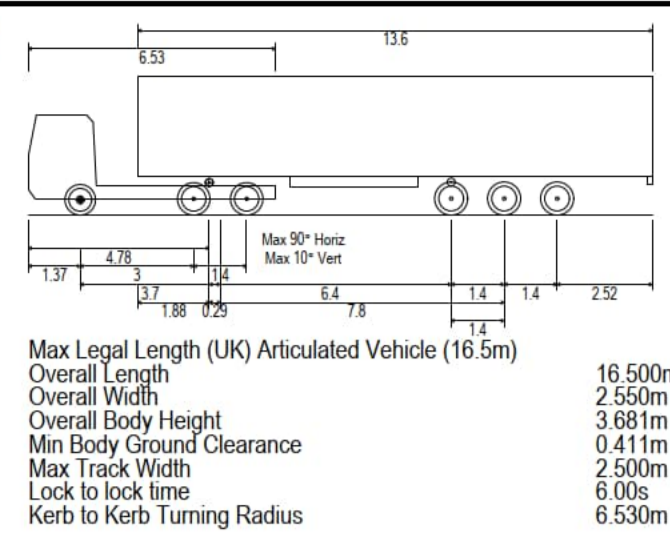

INSET A: ARTICULATED VEHICLE MANOEUVRE LEFT TURN OUT OF ACCESS ONTO BASSINGHAM ROAD HEADING EAST - SCALE 1:500

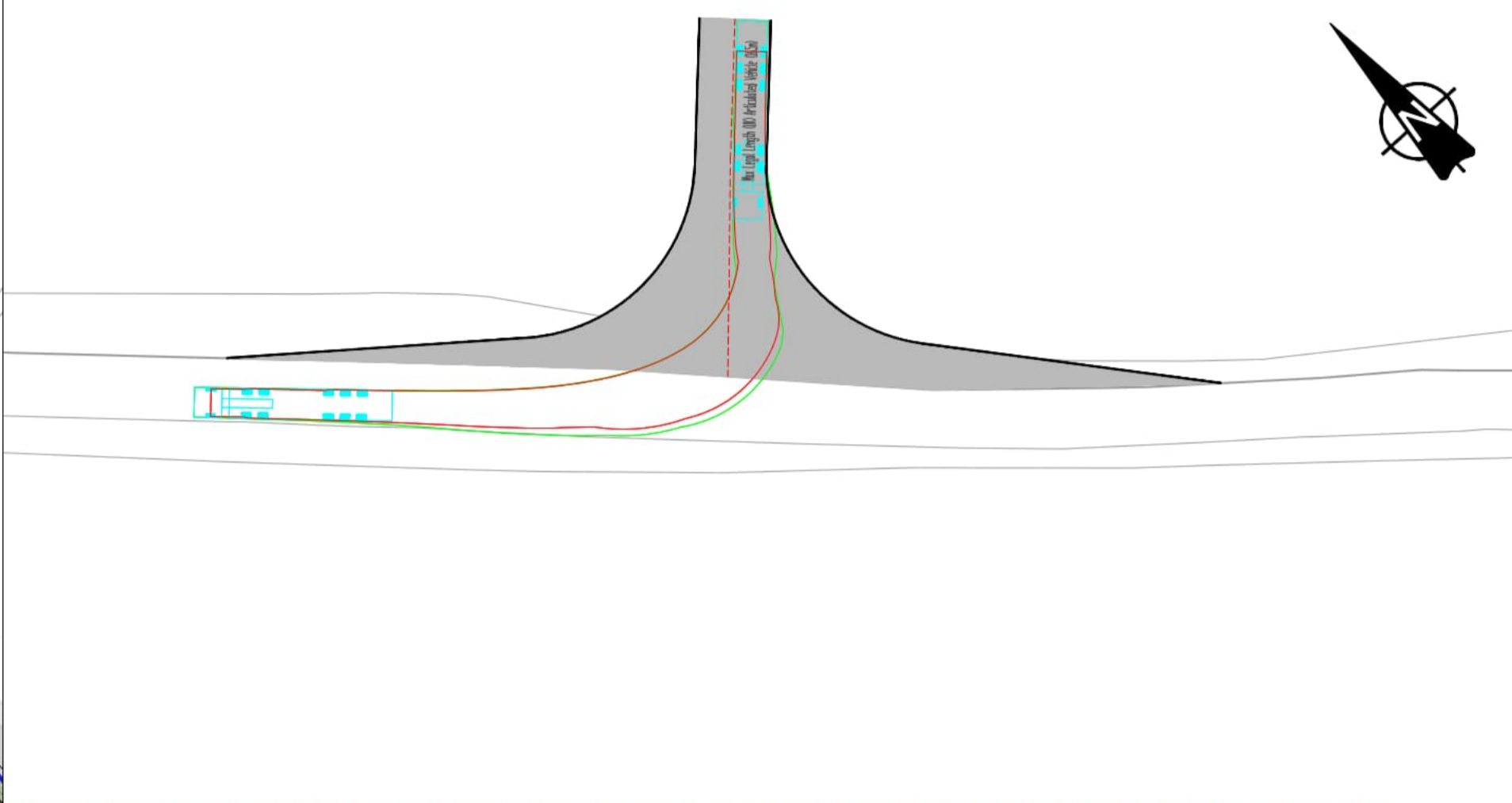

INSET B: ARTICULATED VEHICLE MANOEUVRE RIGHT TURN OUT OF ACCESS ONTO BASSINGHAM ROAD HEADING WEST - SCALE 1:500

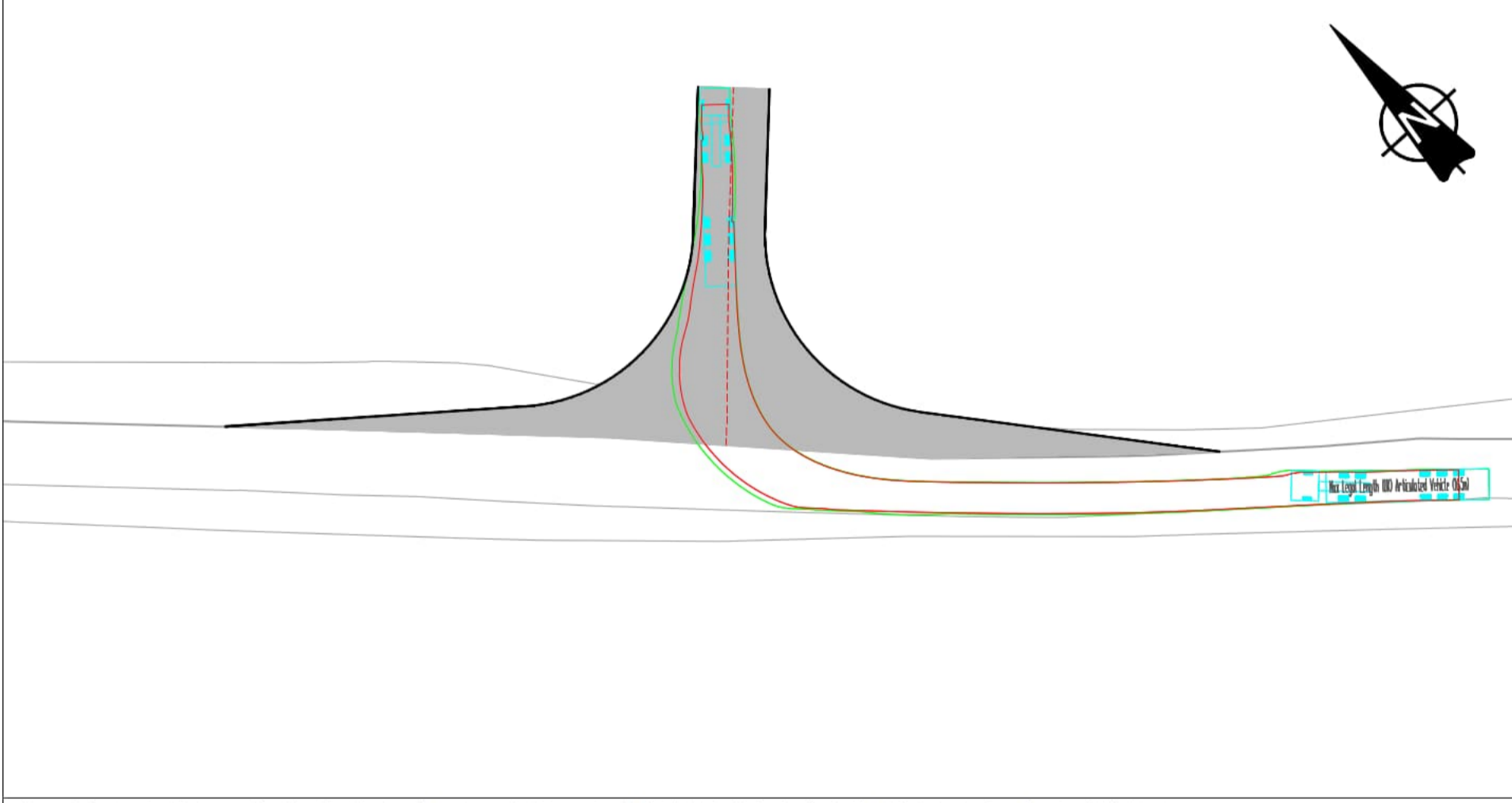

INSET C: ARTICULATED VEHICLE HEADING WEST ON BASSINGHAM ROAD RIGHT TURN INTO ACCESS - SCALE 1:500

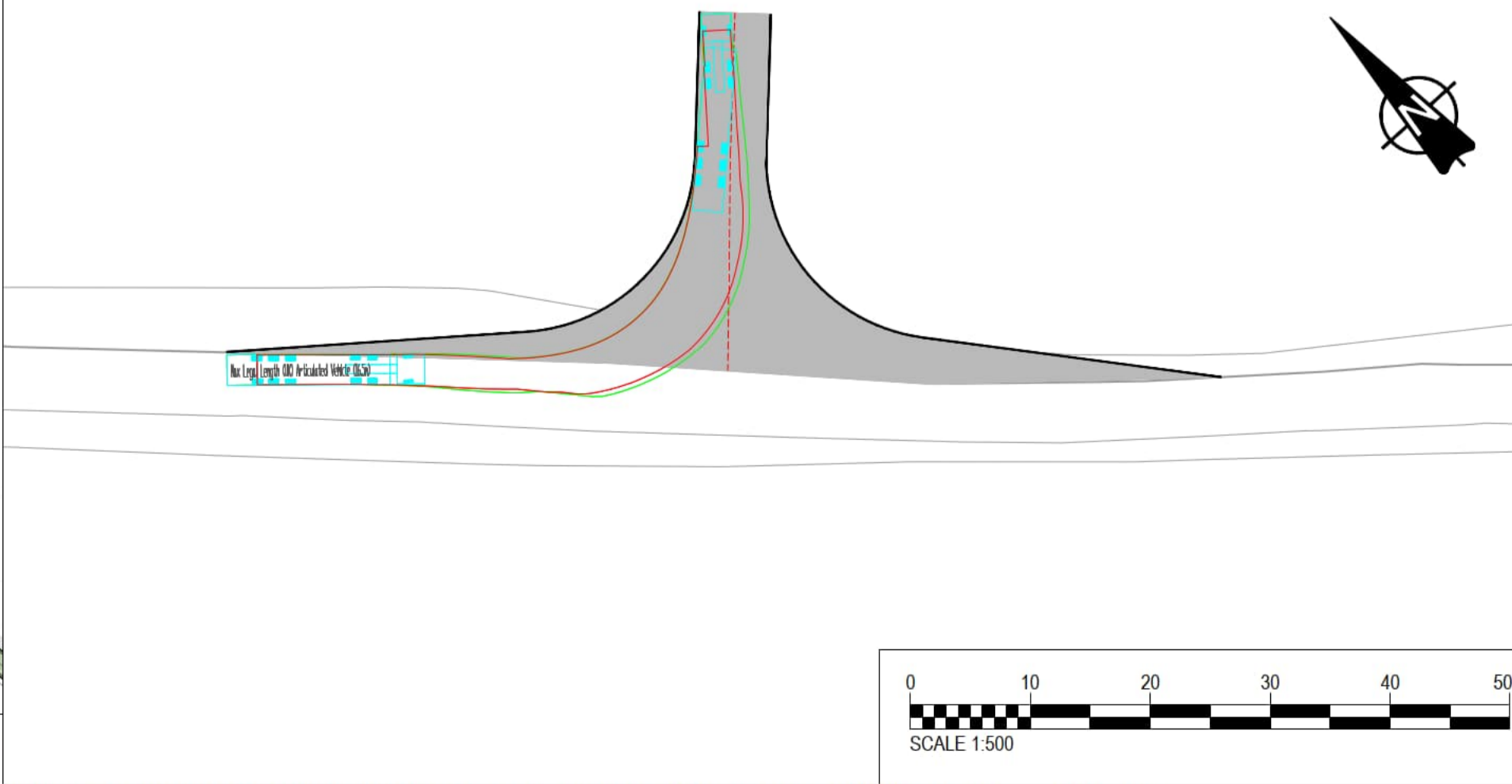

INSET D: ARTICULATED VEHICLE HEADING EAST ON BASSINGHAM ROAD LEFT TURN INTO ACCESS - SCALE 1:500

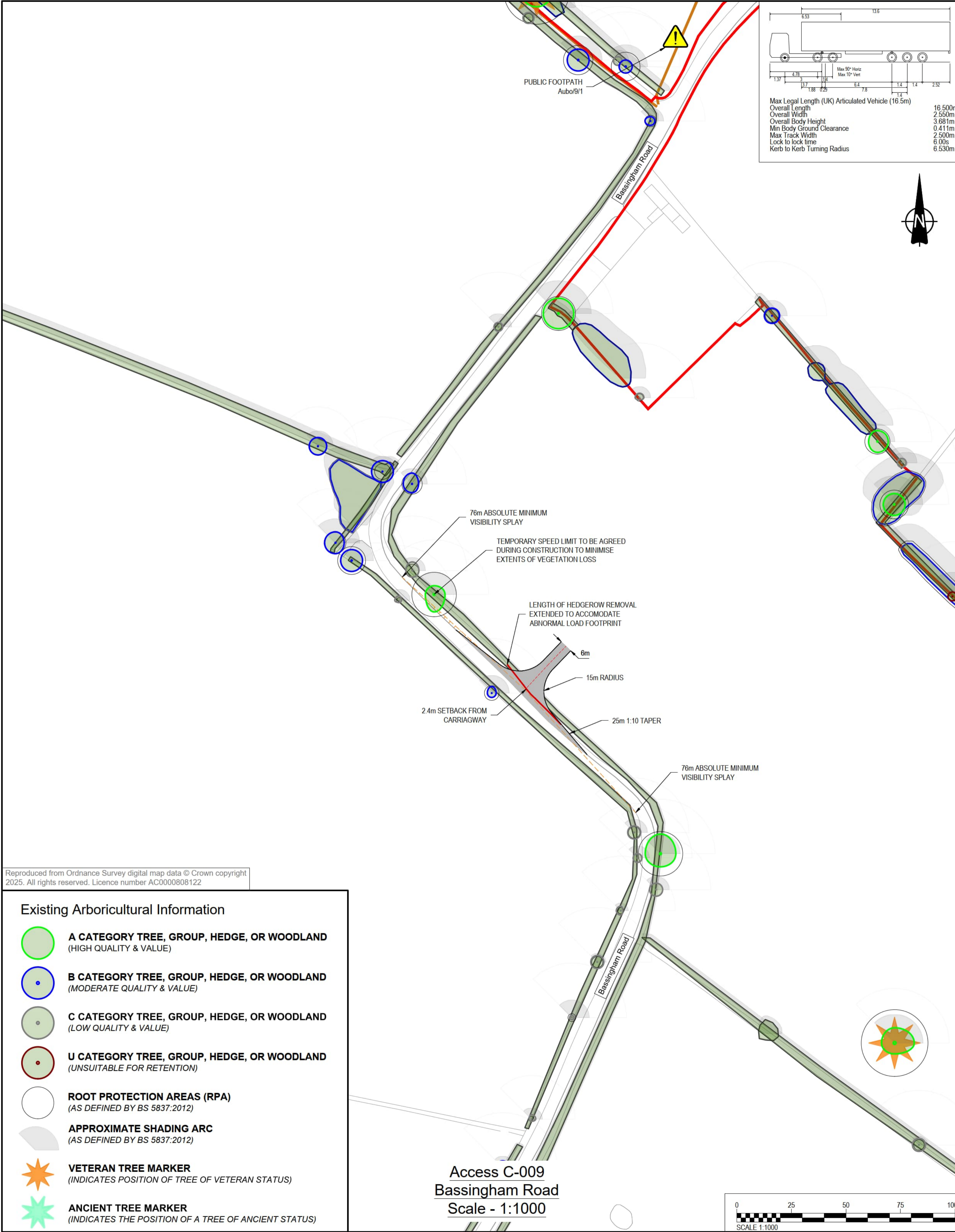

Reproduced from Ordnance Survey digital map data © Crown copyright 2025. All rights reserved. Licence number AC0000808122

**Existing Arboicultural Information**

- A CATEGORY TREE, GROUP, HEDGE, OR WOODLAND** (HIGH QUALITY & VALUE)
- B CATEGORY TREE, GROUP, HEDGE, OR WOODLAND** (MODERATE QUALITY & VALUE)
- C CATEGORY TREE, GROUP, HEDGE, OR WOODLAND** (LOW QUALITY & VALUE)
- U CATEGORY TREE, GROUP, HEDGE, OR WOODLAND** (UNSUITABLE FOR RETENTION)
- ROOT PROTECTION AREAS (RPA)** (AS DEFINED BY BS 5837:2012)
- APPROXIMATE SHADING ARC** (AS DEFINED BY BS 5837:2012)
- VETERAN TREE MARKER** (INDICATES POSITION OF TREE OF VETERAN STATUS)
- ANCIENT TREE MARKER** (INDICATES THE POSITION OF A TREE OF ANCIENT STATUS)

**Access C-009**  
 Basingham Road  
 Scale - 1:1000

This drawing has been prepared for the use of AECOM's client. It may not be used, modified, reproduced or relied upon by third parties, except as agreed by AECOM or as required by law. AECOM accepts no responsibility, and denies any liability whatsoever, to any party that uses or relies on this drawing without AECOM's express written consent. Do not scale this document.

- NOTES**
- This drawing is to be read in conjunction with all other relevant documentation.
  - Do not scale from this drawing, use only printed dimensions.
  - All dimensions in meters, all chainages, levels and coordinates are in meters unless defined otherwise.
  - This drawing is to be read in conjunction with the project Health & Safety File for any identified potential risks.
  - Vegetation to be removed denotes any vegetation features (such as hedgerows) that need to be removed to provide the required junction visibility. Any verge grassland is not to be removed but managed by the relevant maintainer to a low height so as to not impact upon junction visibility.
  - Vehicle tracking shown is indicative only, and represents approximate vehicle size & arrangement for the design vehicle shown.
  - Junction visibility for the access is based upon visibility parameters derived using 85th Percentile Speed Survey Data received on 1st December 2023.
  - These plans should also be read in conjunction with ES Volume 6.2 Appendix 10-H Arboricultural Impact Assessment, for details on hedgerow removal and tree protection

- LEGEND**
- Extent of Access Footprint
  - DCO Site Boundary
  - Existing Public Rights of Way
  - Vehicle body
  - Vehicle body path
  - Vehicle load
  - Vehicle load path
  - Vehicle wheels path
  - Edge of road
  - Land not included in the DCO Site Boundary
  - Junction Visibility Absolute Min.
  - Vegetation to be removed Absolute Min. Vis Splay
  - Junction Visibility DMRB Min.
  - Vegetation to be removed DMRB Min. Vis Splay
  - Indicative Hedgerow Removal Absolute Min. Vis Splay
  - Indicative Hedgerow Removal for Bellmouth Access
  - Approximate Structure Footprint
  - Health and Safety Risk Identifier

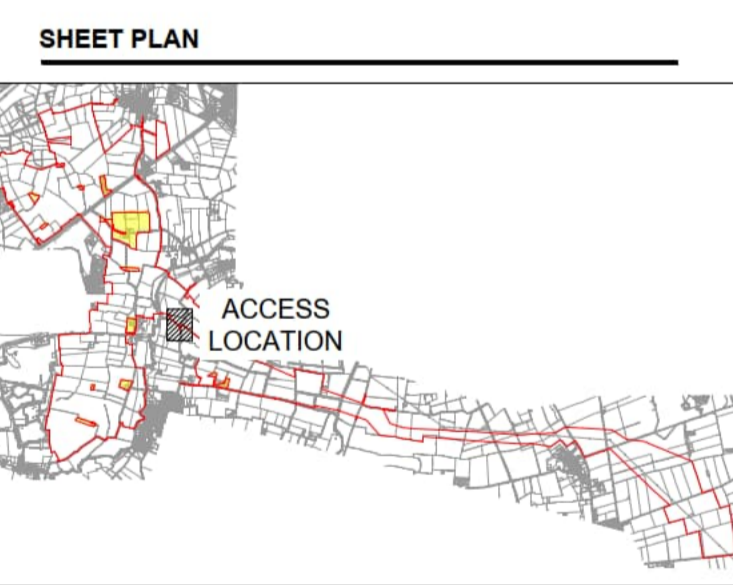

**ISSUE/REVISION**

NO	DATE	DESCRIPTION
P01	17/07/2025	DCO SUBMISSION

**LEGISLATION**  
 Regulation 5(2)(k) Infrastructure Planning (Applications: Prescribed Forms and Procedure) Regulations 2009

**ISSUE PURPOSE**  
 DCO SUBMISSION

**FIGURE TITLE**

FIGURE TITLE	REV.
ACCESS C-010	01

**DOCUMENT REFERENCE**  
 EN10154/APP/7.18

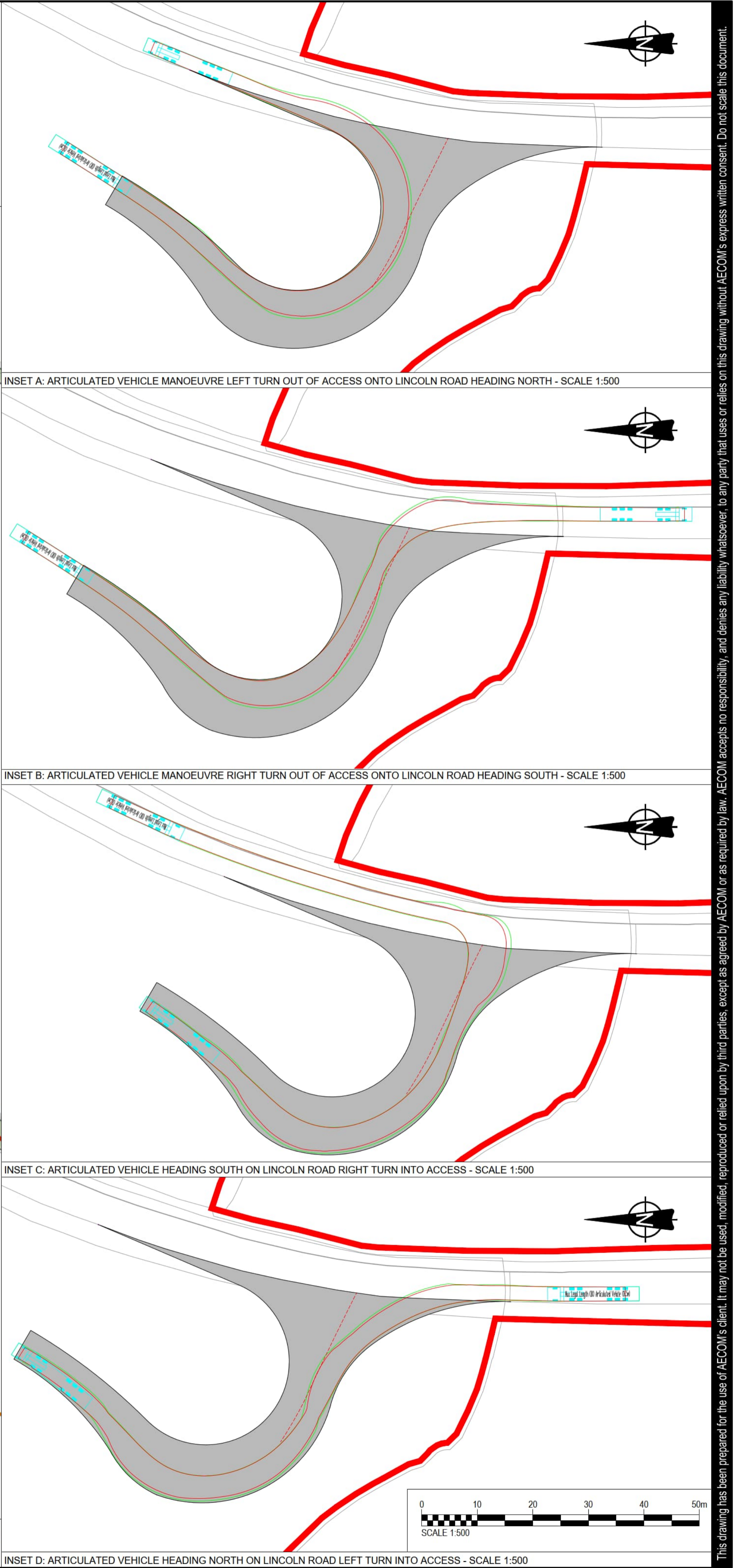
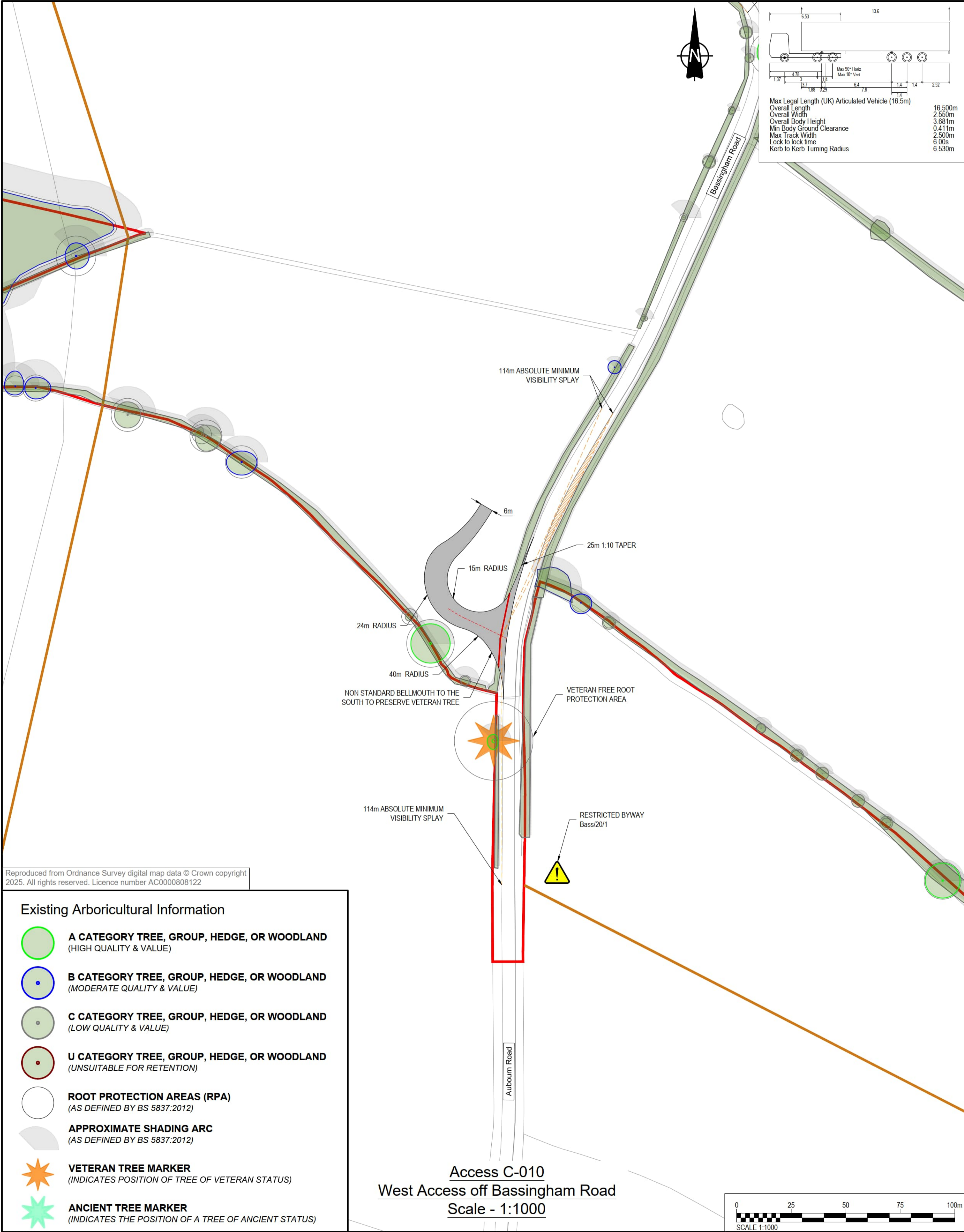

**Existing Arboricultural Information**

- A CATEGORY TREE, GROUP, HEDGE, OR WOODLAND (HIGH QUALITY & VALUE)**
- B CATEGORY TREE, GROUP, HEDGE, OR WOODLAND (MODERATE QUALITY & VALUE)**
- C CATEGORY TREE, GROUP, HEDGE, OR WOODLAND (LOW QUALITY & VALUE)**
- U CATEGORY TREE, GROUP, HEDGE, OR WOODLAND (UNSUITABLE FOR RETENTION)**
- ROOT PROTECTION AREAS (RPA) (AS DEFINED BY BS 5837:2012)**
- APPROXIMATE SHADING ARC (AS DEFINED BY BS 5837:2012)**
- VETERAN TREE MARKER (INDICATES POSITION OF TREE OF VETERAN STATUS)**
- ANCIENT TREE MARKER (INDICATES THE POSITION OF A TREE OF ANCIENT STATUS)**

**Access C-010**  
 West Access off Bassingham Road  
 Scale - 1:1000

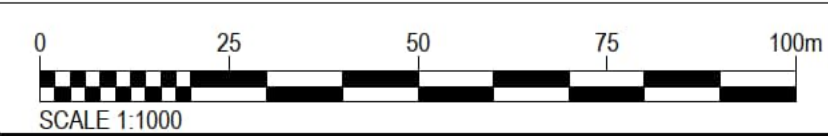

This drawing has been prepared for the use of AECOM's client. It may not be used, modified, reproduced or relied upon by third parties, except as agreed by AECOM or as required by law. AECOM accepts no responsibility, and denies any liability whatsoever, to any party that uses or relies on this drawing without AECOM's express written consent. Do not scale this document.

- NOTES**
1. This drawing is to be read in conjunction with all other relevant documentation.
  2. Do not scale from this drawing, use only printed dimensions.
  3. All dimensions in meters, all chainages, levels and coordinates are in meters unless defined otherwise.
  4. This drawing is to be read in conjunction with the project Health & Safety File for any identified potential risks.
  5. Vegetation to be removed denotes any vegetation features (such as hedgerows) that need to be removed to provide the required junction visibility. Any verge grassland is not to be removed but managed by the relevant maintainer to a low height so as to not impact upon junction visibility.
  6. Vehicle tracking shown is indicative only, and represents approximate vehicle size & arrangement for the design vehicle shown.
  7. Junction visibility for the access is based upon visibility parameters derived using 85th Percentile Speed Survey Data received on 1st December 2023.
  8. These plans should also be read in conjunction with ES Volume 6.2 Appendix 10-H Arboricultural Impact Assessment, for details on hedgerow removal and tree protection.

- LEGEND**
- Extent of Access Footprint
  - DCO Site Boundary
  - Existing Public Rights of Way
  - Vehicle body
  - Vehicle body path
  - Vehicle load
  - Vehicle load path
  - Vehicle wheels path
  - Edge of road
  - Land not included in the DCO Site Boundary
  - Junction Visibility Absolute Min.
  - Vegetation to be removed Absolute Min. Vis Splay
  - Junction Visibility DMRB Min.
  - Vegetation to be removed DMRB Min. Vis Splay
  - Indicative Hedgerow Removal Absolute Min. Vis Splay
  - Indicative Hedgerow Removal for Bellmouth Access
  - Approximate Structure Footprint
  - Health and Safety Risk Identifier

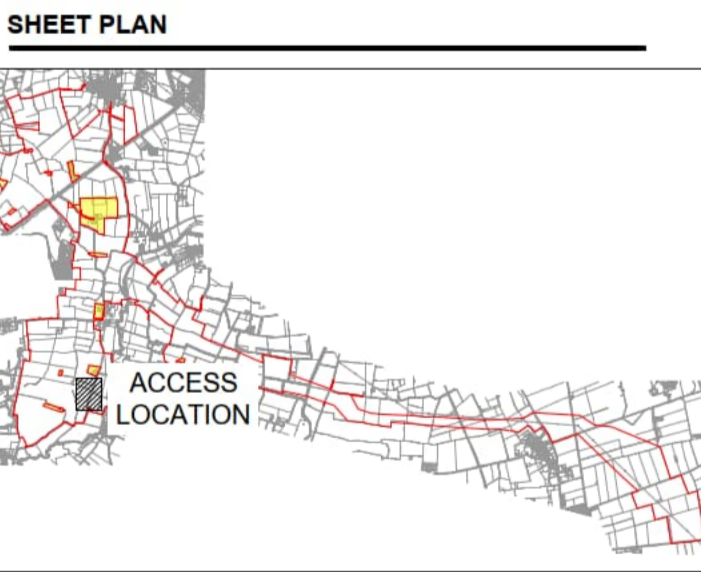

**ISSUE/REVISION**

NO	DATE	DESCRIPTION
P01	17/07/2025	DCO SUBMISSION

**LEGISLATION**  
 Regulation 5(2)(k) Infrastructure Planning (Applications: Prescribed Forms and Procedure) Regulations 2009

**ISSUE PURPOSE**  
 DCO SUBMISSION

FIGURE TITLE	REV.
ACCESS C-011	01

**DOCUMENT REFERENCE**  
 EN010154/APP/7.18

EGRESS MOVEMENTS TO BE BANKSPERSON CONTROLLED TO ENSURE THAT NO EGRESS MOVEMENT IS UNDERTAKEN AT THE SAME TIME AS ARRIVING CONSTRUCTION TRAFFIC.

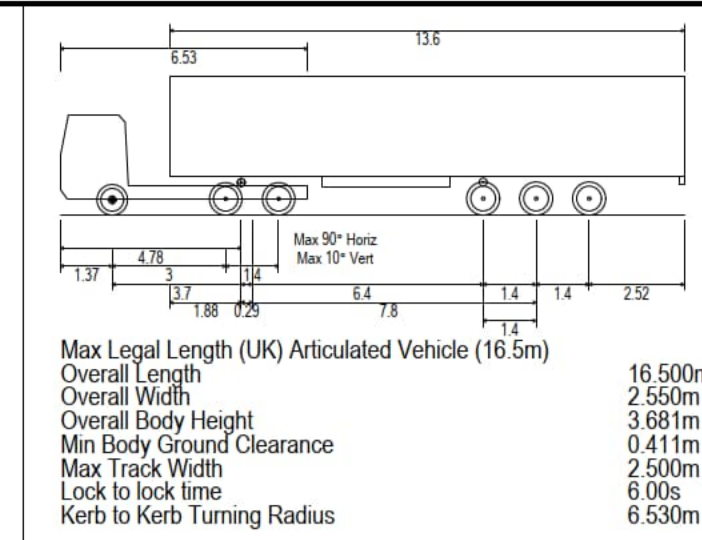

INSET A: ARTICULATED VEHICLE MANOEUVRE LEFT TURN OUT OF ACCESS ONTO CLAY LANE HEADING NORTH - SCALE 1:500

INSET B: ARTICULATED VEHICLE MANOEUVRE RIGHT TURN OUT OF ACCESS ONTO CLAY LANE HEADING SOUTH - SCALE 1:500

INSET C: ARTICULATED VEHICLE HEADING SOUTH ON CLAY LANE RIGHT TURN INTO ACCESS - SCALE 1:500

INSET D: ARTICULATED VEHICLE HEADING NORTH ON CLAY LANE LEFT TURN INTO ACCESS - SCALE 1:500

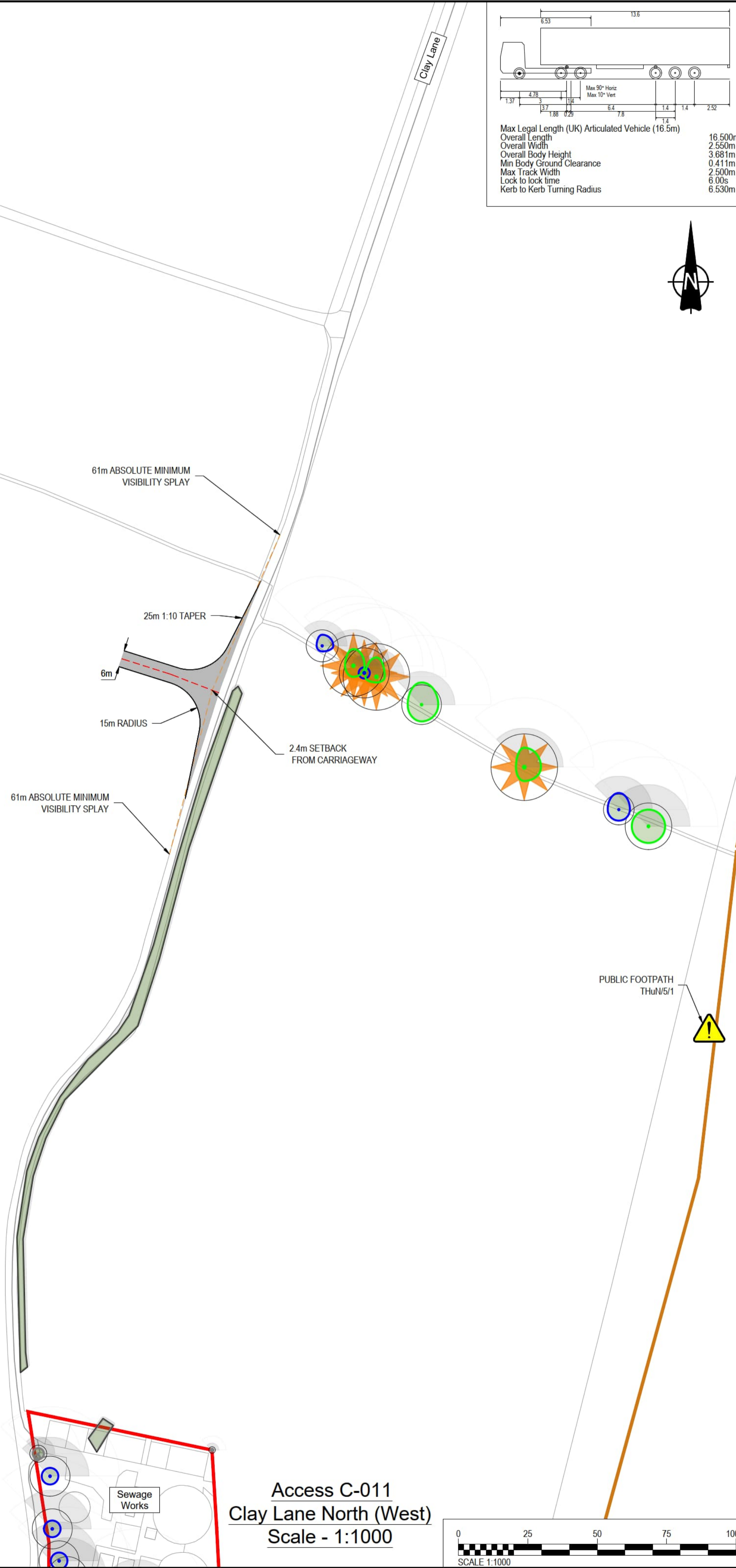

Reproduced from Ordnance Survey digital map data © Crown copyright 2025. All rights reserved. Licence number AC0000808122

**Existing Arboricultural Information**

- A CATEGORY TREE, GROUP, HEDGE, OR WOODLAND** (HIGH QUALITY & VALUE)
- B CATEGORY TREE, GROUP, HEDGE, OR WOODLAND** (MODERATE QUALITY & VALUE)
- C CATEGORY TREE, GROUP, HEDGE, OR WOODLAND** (LOW QUALITY & VALUE)
- U CATEGORY TREE, GROUP, HEDGE, OR WOODLAND** (UNSUITABLE FOR RETENTION)
- ROOT PROTECTION AREAS (RPA)** (AS DEFINED BY BS 5837:2012)
- APPROXIMATE SHADING ARC** (AS DEFINED BY BS 5837:2012)
- VETERAN TREE MARKER** (INDICATES POSITION OF TREE OF VETERAN STATUS)
- ANCIENT TREE MARKER** (INDICATES THE POSITION OF A TREE OF ANCIENT STATUS)

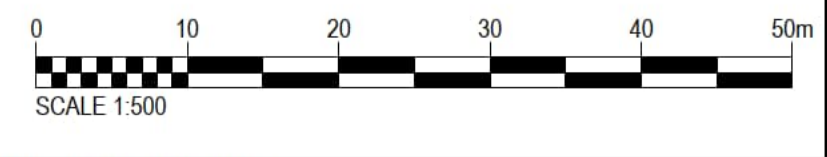
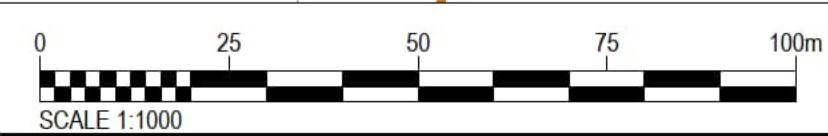



- NOTES**
- This drawing is to be read in conjunction with all other relevant documentation.
  - Do not scale from this drawing, use only printed dimensions.
  - All dimensions in meters, all chainages, levels and coordinates are in meters unless defined otherwise.
  - This drawing is to be read in conjunction with the project Health & Safety File for any identified potential risks.
  - Vegetation to be removed denotes any vegetation features (such as hedgerows) that need to be removed to provide the required junction visibility. Any verge grassland is not to be removed but managed by the relevant maintainer to a low height so as to not impact upon junction visibility.
  - Vehicle tracking shown is indicative only, and represents approximate vehicle size & arrangement for the design vehicle shown.
  - These plans should also be read in conjunction with ES Volume 6.2 Appendix 10-H Arboricultural Impact Assessment, for details on hedgerow removal and tree protection.
  - Junction Visibility for the access is based on upon visibility parameters derived using 85th Percentile Speed Survey Data received on 1st December 2023.

- LEGEND**
- Extent of Access Footprint
  - DCO Site Boundary
  - Existing Public Rights of Way
  - Vehicle body
  - Vehicle body path
  - Vehicle load
  - Vehicle load path
  - Vehicle wheels path
  - Edge of road
  - Land not included in the DCO Site Boundary
  - Junction Visibility Absolute Min.
  - Vegetation to be removed Absolute Min. Vis Splay
  - Junction Visibility DMRB Min.
  - Vegetation to be removed DMRB Min. Vis Splay
  - Indicative Hedgerow Removal Absolute Min. Vis Splay
  - Indicative Hedgerow Removal for Bellmouth Access
  - Approximate Structure Footprint
  - Health and Safety Risk Identifier

**SHEET PLAN**

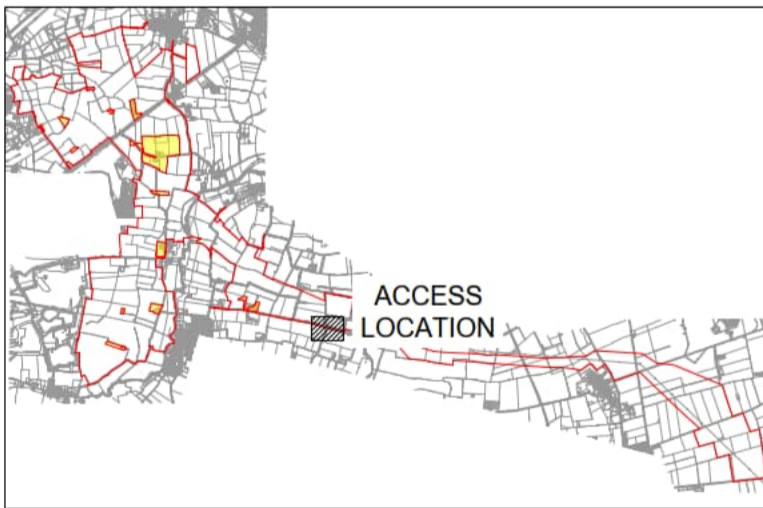

**ISSUE/REVISION**

NO	DATE	DESCRIPTION
P01	17/07/2025	DCO SUBMISSION

**LEGISLATION**

Regulation 5(2)(k) Infrastructure Planning (Applications: Prescribed Forms and Procedure) Regulations 2009

**ISSUE PURPOSE**

DCO SUBMISSION

FIGURE TITLE	REV.
ACCESS C-013	01

**DOCUMENT REFERENCE**

EN010154/APP/7.18

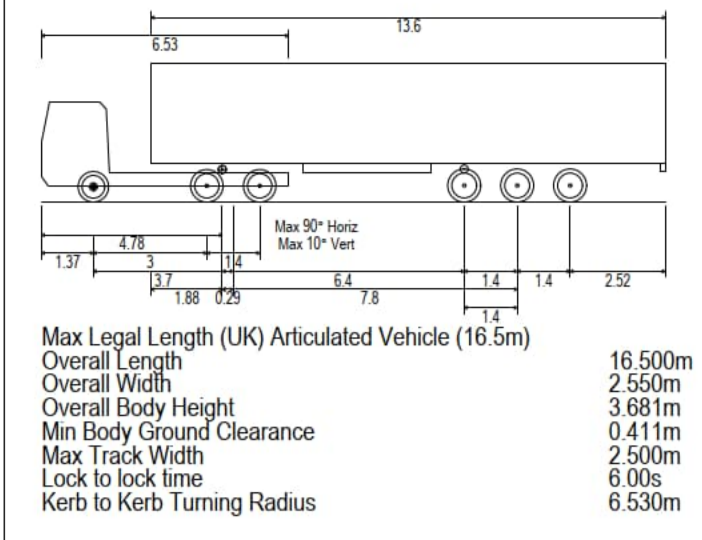
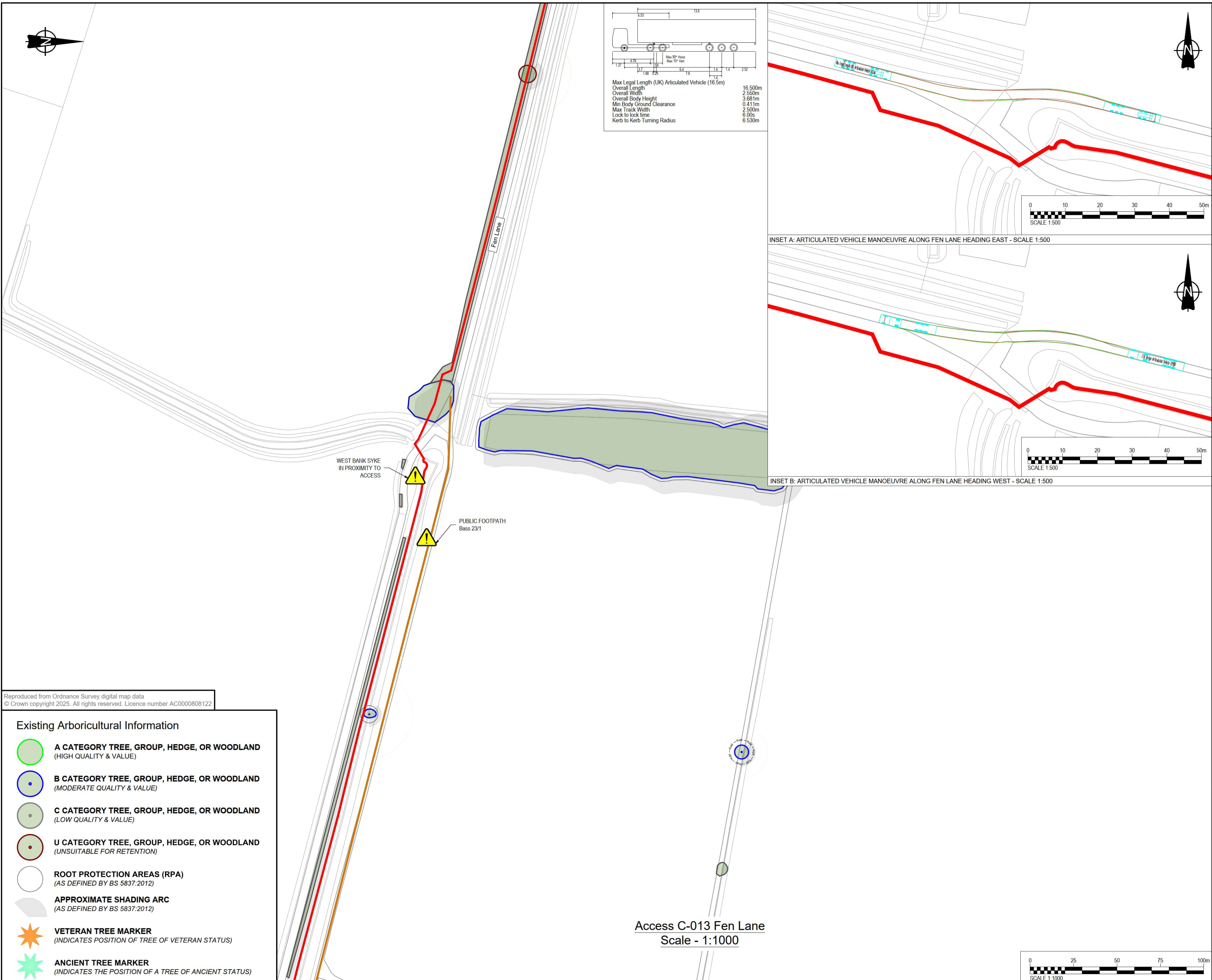

INSET A: ARTICULATED VEHICLE MANOEUVRE ALONG FEN LANE HEADING EAST - SCALE 1:500

INSET B: ARTICULATED VEHICLE MANOEUVRE ALONG FEN LANE HEADING WEST - SCALE 1:500









Access C-013 Fen Lane  
 Scale - 1:1000

Reproduced from Ordnance Survey digital map data  
 © Crown copyright 2025. All rights reserved. Licence number AC0000808122

**Existing Arboricultural Information**

- A CATEGORY TREE, GROUP, HEDGE, OR WOODLAND**  
 (HIGH QUALITY & VALUE)
- B CATEGORY TREE, GROUP, HEDGE, OR WOODLAND**  
 (MODERATE QUALITY & VALUE)
- C CATEGORY TREE, GROUP, HEDGE, OR WOODLAND**  
 (LOW QUALITY & VALUE)
- U CATEGORY TREE, GROUP, HEDGE, OR WOODLAND**  
 (UNSUITABLE FOR RETENTION)
- ROOT PROTECTION AREAS (RPA)**  
 (AS DEFINED BY BS 5837:2012)
- APPROXIMATE SHADING ARC**  
 (AS DEFINED BY BS 5837:2012)
- VETERAN TREE MARKER**  
 (INDICATES POSITION OF TREE OF VETERAN STATUS)
- ANCIENT TREE MARKER**  
 (INDICATES THE POSITION OF A TREE OF ANCIENT STATUS)

**Existing Arboricultural Information**

-  **A CATEGORY TREE, GROUP, HEDGE, OR WOODLAND**  
(HIGH QUALITY & VALUE)
-  **B CATEGORY TREE, GROUP, HEDGE, OR WOODLAND**  
(MODERATE QUALITY & VALUE)
-  **C CATEGORY TREE, GROUP, HEDGE, OR WOODLAND**  
(LOW QUALITY & VALUE)
-  **U CATEGORY TREE, GROUP, HEDGE, OR WOODLAND**  
(UNSUITABLE FOR RETENTION)
-  **ROOT PROTECTION AREAS (RPA)**  
(AS DEFINED BY BS 5837:2012)
-  **APPROXIMATE SHADING ARC**  
(AS DEFINED BY BS 5837:2012)
-  **VETERAN TREE MARKER**  
(INDICATES POSITION OF TREE OF VETERAN STATUS)
-  **ANCIENT TREE MARKER**  
(INDICATES THE POSITION OF A TREE OF ANCIENT STATUS)

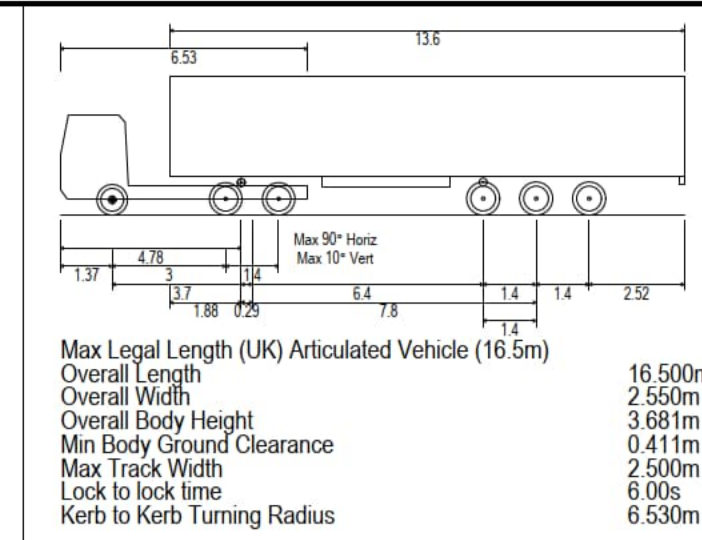

EGRESS MOVEMENTS TO BE BANKSPERSON CONTROLLED TO ENSURE THAT NO EGRESS MOVEMENT IS UNDERTAKEN AT THE SAME TIME AS ARRIVING CONSTRUCTION TRAFFIC.

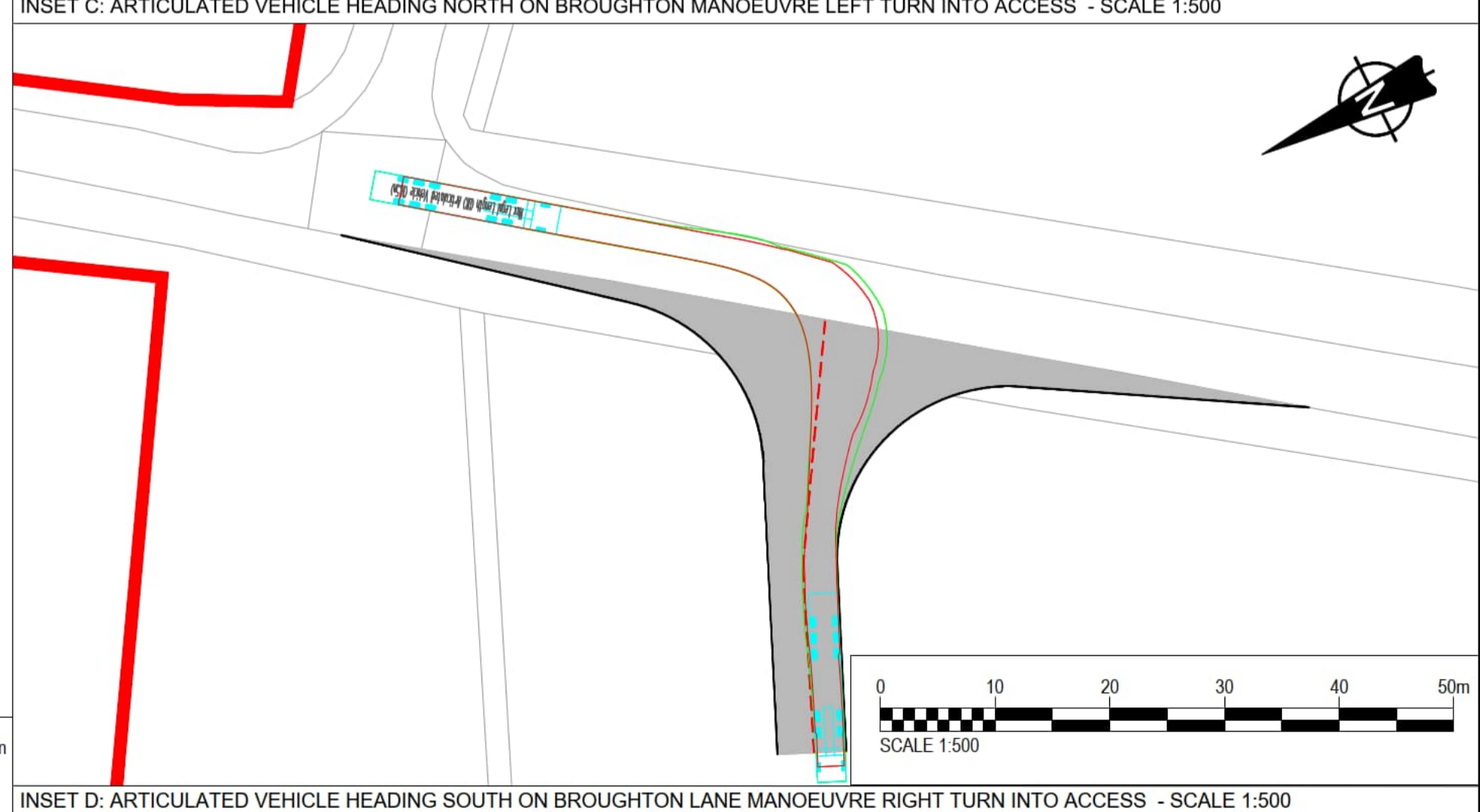
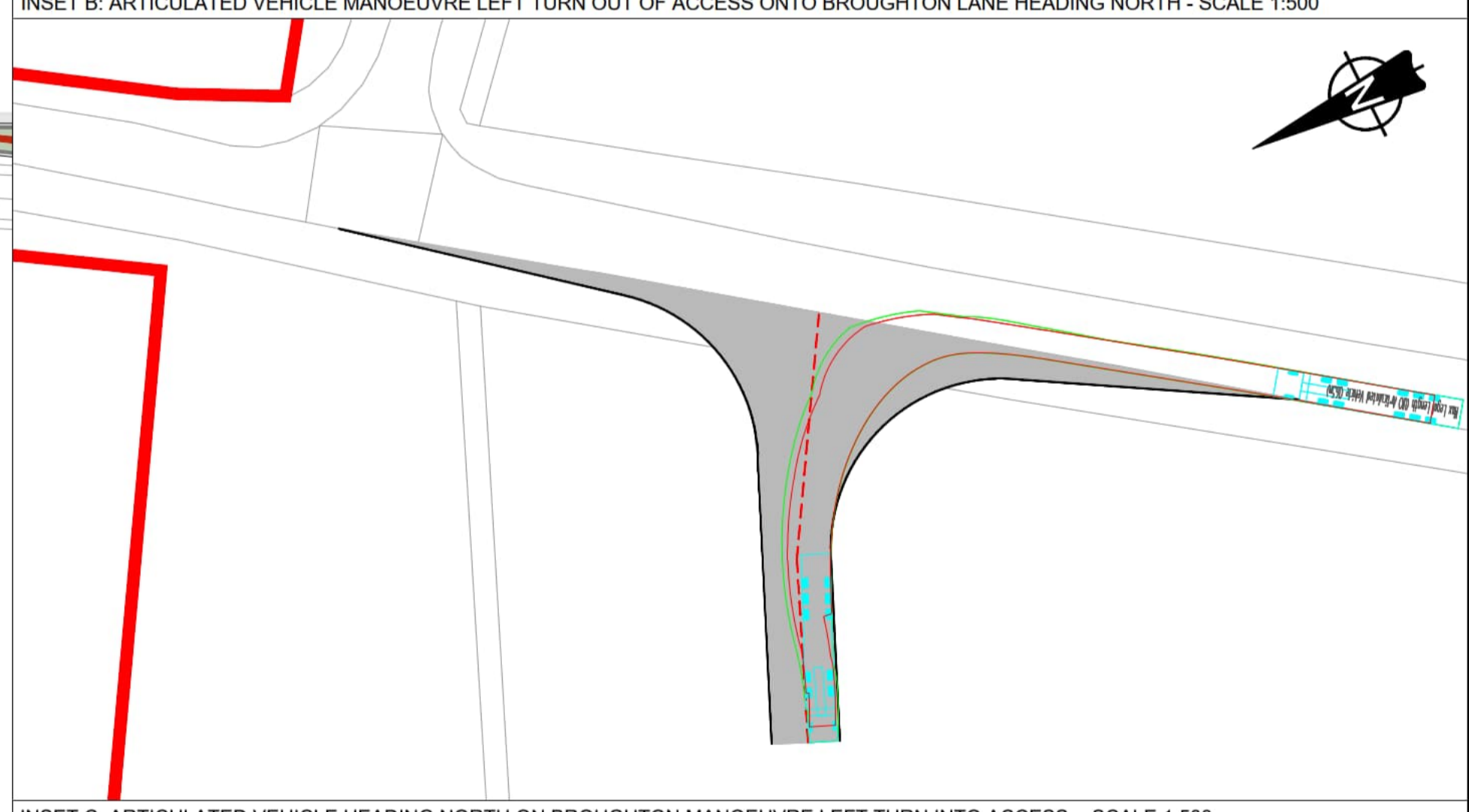
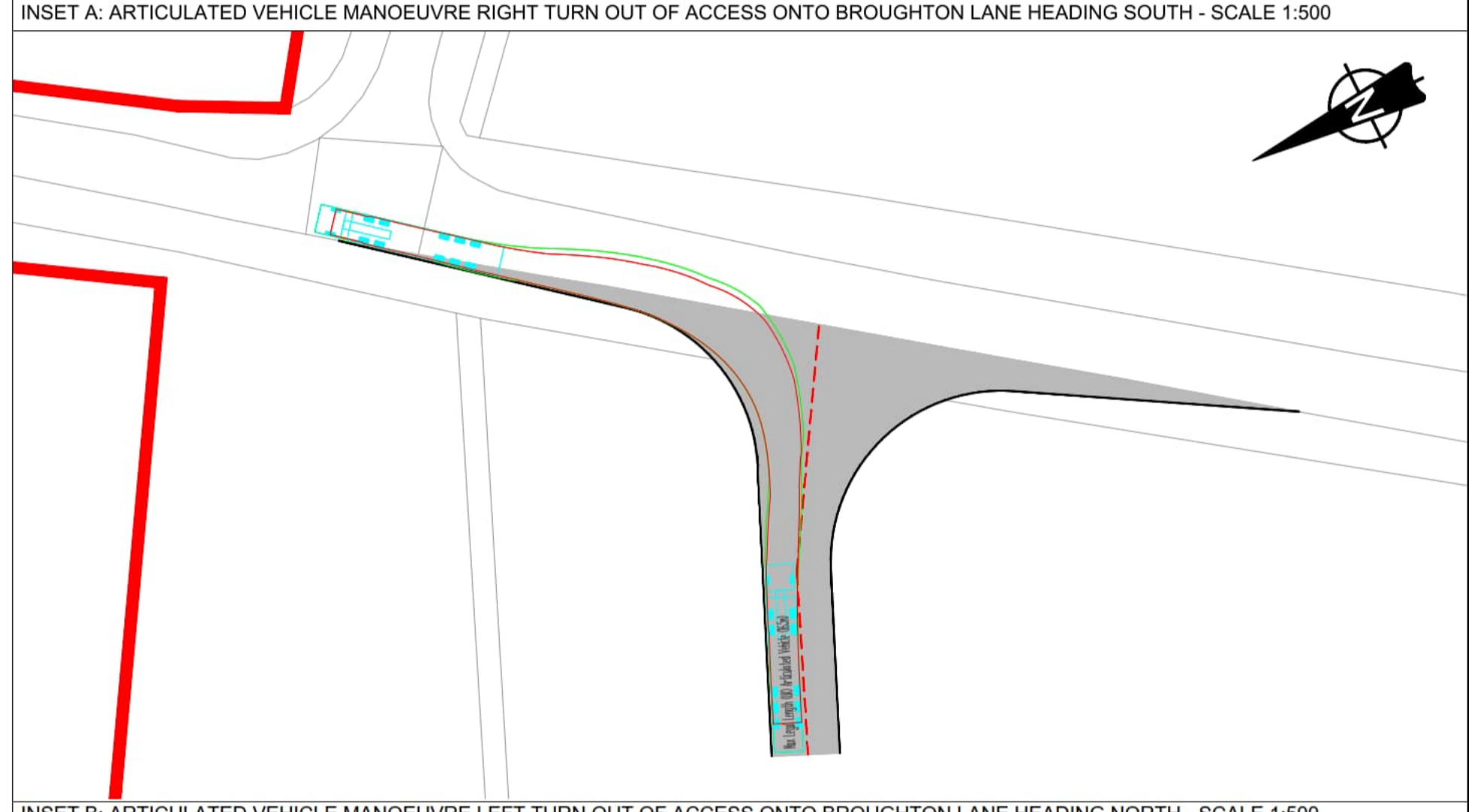
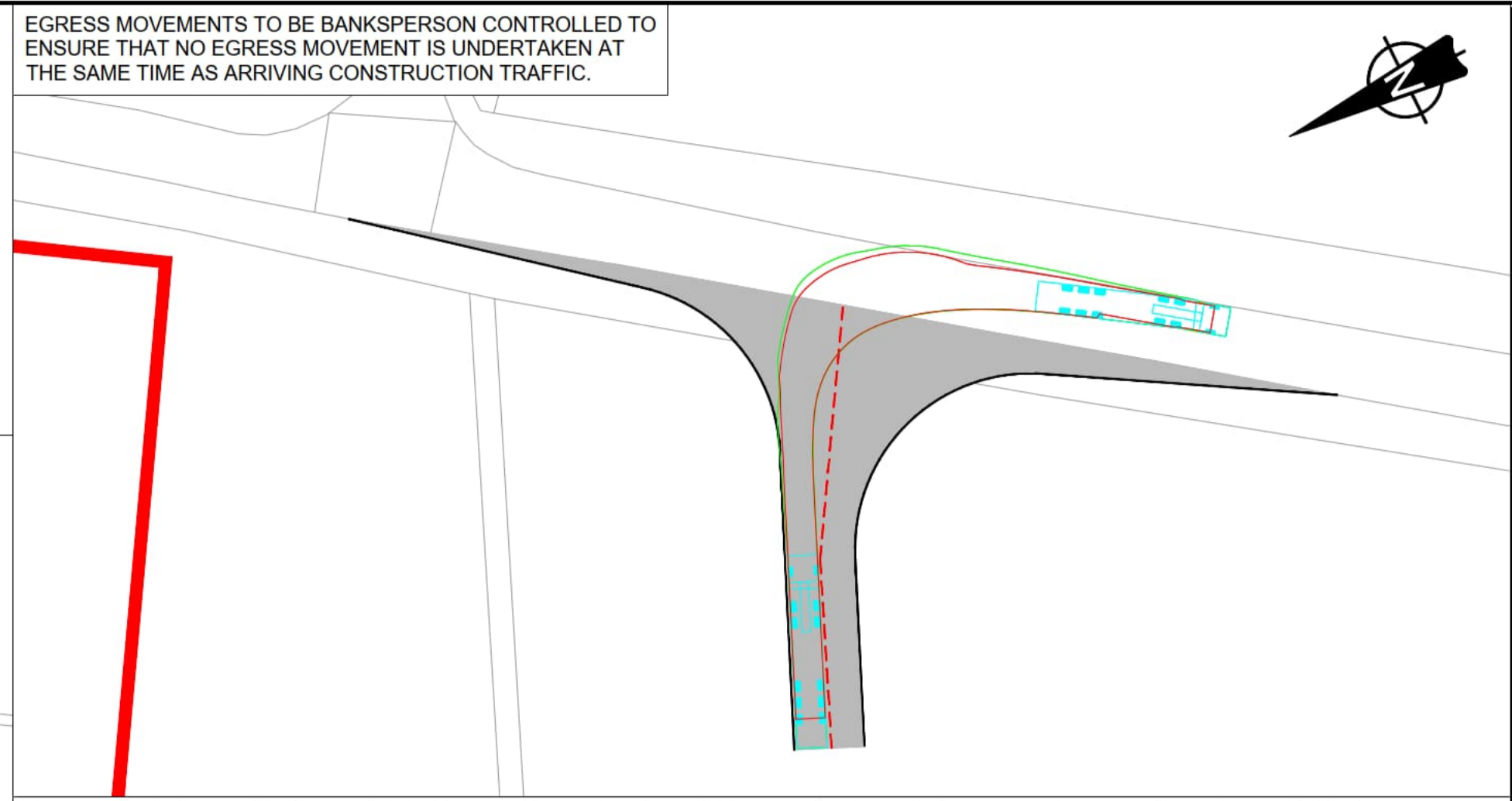
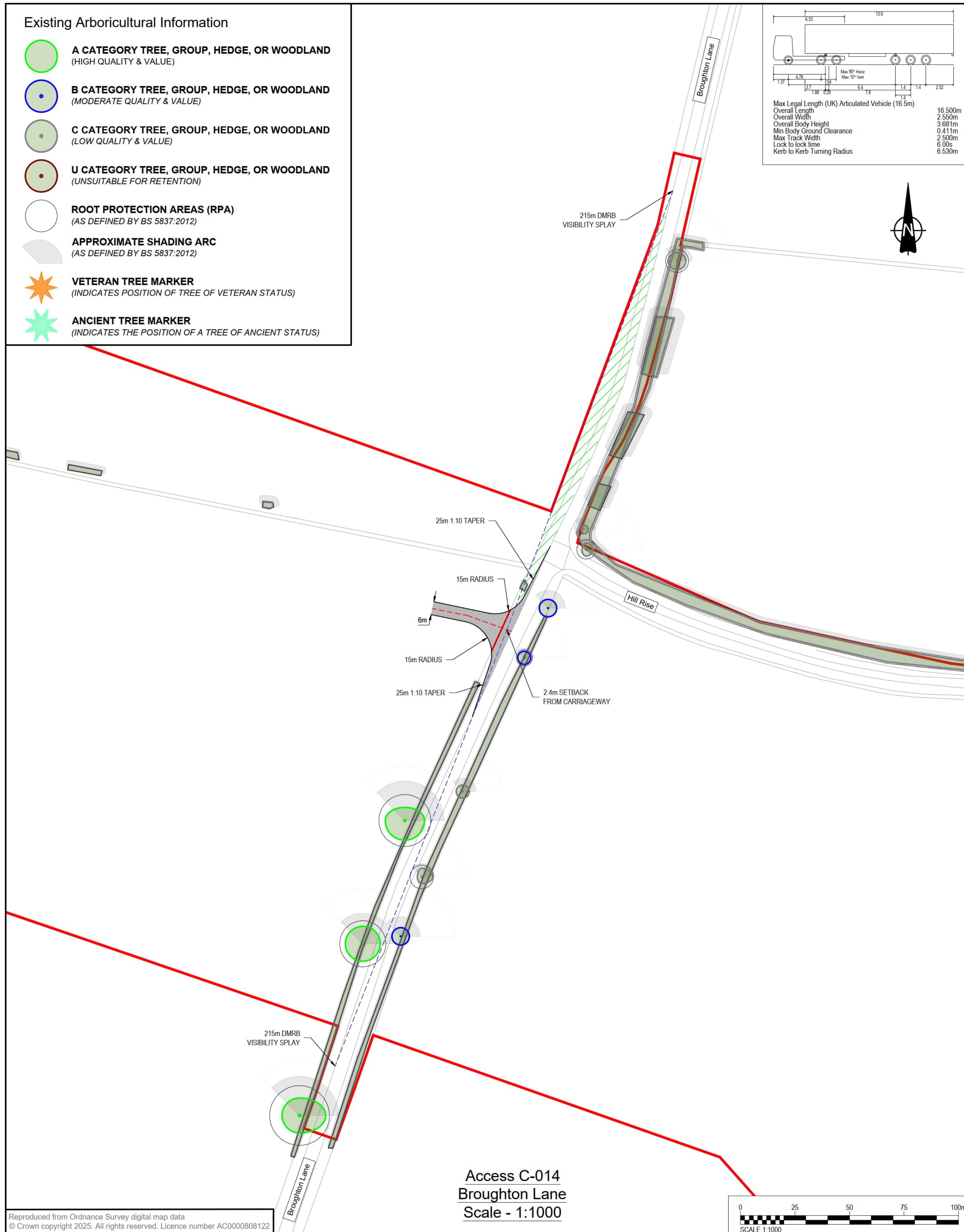

**PROJECT**  
Fosse Green Energy

**CLIENT**  
Fosse Green Energy Ltd

**CONSULTANT**  
AECOM

- NOTES**
- This drawing is to be read in conjunction with all other relevant documentation.
  - Do not scale from this drawing, use only printed dimensions.
  - All dimensions in meters, all chainages, levels and coordinates are in meters unless defined otherwise.
  - This drawing is to be read in conjunction with the project Health & Safety File for any identified potential risks.
  - Vegetation to be removed denotes any vegetation features (such as hedgerows) that need to be removed to provide the required junction visibility. Any verge grassland is not to be removed but managed by the relevant maintainer to a low height so as to not impact upon junction visibility.
  - Vehicle tracking shown is indicative only, and represents approximate vehicle size & arrangement for the design vehicle shown.
  - These plans should also be read in conjunction with ES Volume 6.2 Appendix 10-H Arboricultural Impact Assessment, for details on hedgerow removal and tree protection.
  - Junction Visibility for the access is based on DMRB CD109, Table 2.10.

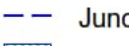
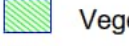
- LEGEND**
-  Extent of Access Footprint
  -  DCO Site Boundary
  -  Existing Public Rights of Way
  -  Vehicle body
  -  Vehicle body path
  -  Vehicle load
  -  Vehicle load path
  -  Vehicle wheels path
  -  Edge of road
  -  Land not included in the DCO Site Boundary
  -  Junction Visibility Absolute Min.
  -  Junction Visibility DMRB Min.
  -  Vegetation to be removed DMRB Min. Vis Splay
  -  Indicative Hedgerow Removal Absolute Min. Vis Splay
  -  Indicative Hedgerow Removal for Bellmouth Access
  -  Approximate Structure Footprint
  -  Health and Safety Risk Identifier

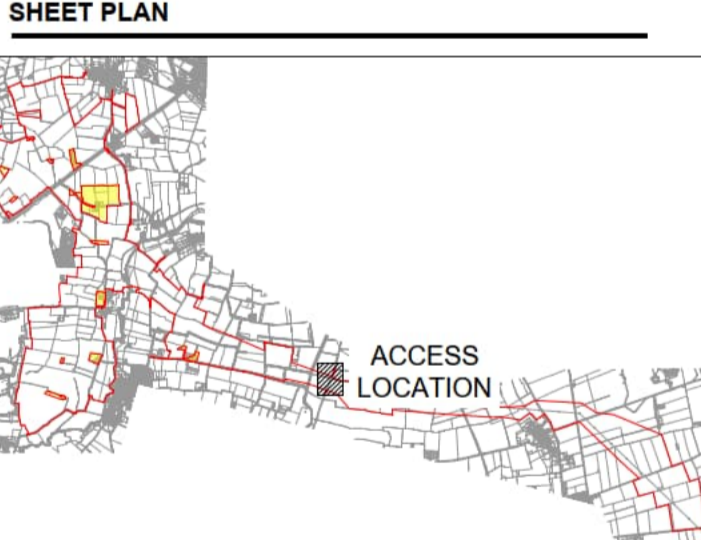

**ISSUE/REVISION**

NO.	DATE	DESCRIPTION
P01	17/07/2025	DCO SUBMISSION

**LEGISLATION**  
Regulation 5(2)(k) Infrastructure Planning (Applications: Prescribed Forms and Procedure) Regulations 2009

**ISSUE PURPOSE**  
DCO SUBMISSION

FIGURE TITLE	REV.
ACCESS C-014	01

**DOCUMENT REFERENCE**  
EN10154/APP/7.18

This drawing has been prepared for the use of AECOM's client. It may not be used, modified, reproduced or relied upon by third parties, except as agreed by AECOM or as required by law. AECOM accepts no responsibility, and denies any liability whatsoever, to any party that uses or relies on this drawing without AECOM's express written consent. Do not scale this document.





- NOTES**
- This drawing is to be read in conjunction with all other relevant documentation.
  - Do not scale from this drawing, use only printed dimensions.
  - All dimensions in meters, all chainages, levels and coordinates are in meters unless defined otherwise.
  - This drawing is to be read in conjunction with the project Health & Safety File for any identified potential risks.
  - Vegetation to be removed denotes any vegetation features (such as hedgerows) that need to be removed to provide the required junction visibility. Any verge grassland is not to be removed but managed by the relevant maintainer to a low height so as to not impact upon junction visibility.
  - Vehicle tracking shown is indicative only, and represents approximate vehicle size & arrangement for the design vehicle shown.
  - These plans should also be read in conjunction with ES Volume 6.2 Appendix 10-H Arboricultural Impact Assessment, for details on hedgerow removal and tree protection.
  - Junction Visibility for the access is based on DMRB CD109, Table 2.10.

- LEGEND**
- Extent of Access Footprint
  - DCO Site Boundary
  - Existing Public Rights of Way
  - Vehicle body
  - Vehicle body path
  - Vehicle load
  - Vehicle load path
  - Vehicle wheels path
  - Edge of road
  - Land not included in the DCO Site Boundary
  - Junction Visibility Absolute Min.
  - Vegetation to be removed Absolute Min. Vis Splay
  - Junction Visibility DMRB Min.
  - Vegetation to be removed DMRB Min. Vis Splay
  - Indicative Hedgerow Removal Absolute Min. Vis Splay
  - Indicative Hedgerow Removal for Bellmouth Access
  - Approximate Structure Footprint
  - Health and Safety Risk Identifier

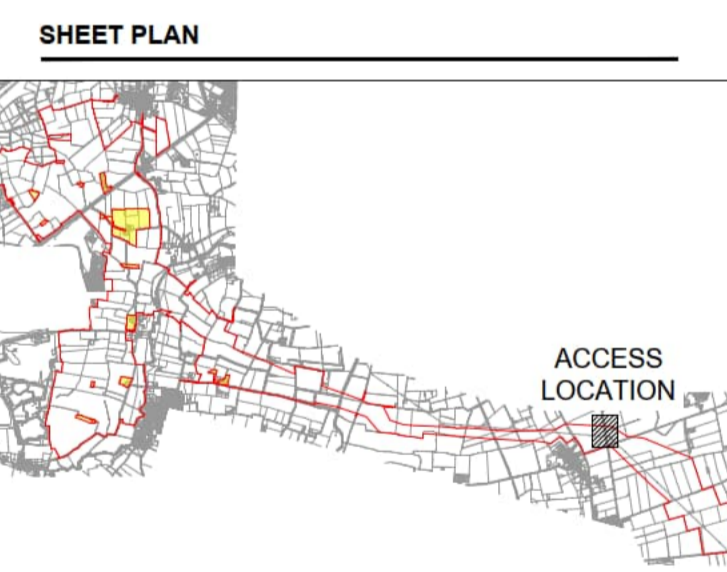

**ISSUE/REVISION**

NO.	DATE	DESCRIPTION
P01	17/07/2025	DCO SUBMISSION

**LEGISLATION**  
 Regulation 5(2)(k) Infrastructure Planning (Applications: Prescribed Forms and Procedure) Regulations 2009

**ISSUE PURPOSE**  
 DCO SUBMISSION

**FIGURE NUMBER**

FIGURE NUMBER	REV.
ACCESS C-017	01

**DOCUMENT REFERENCE**  
 EN010154/APP/7.18

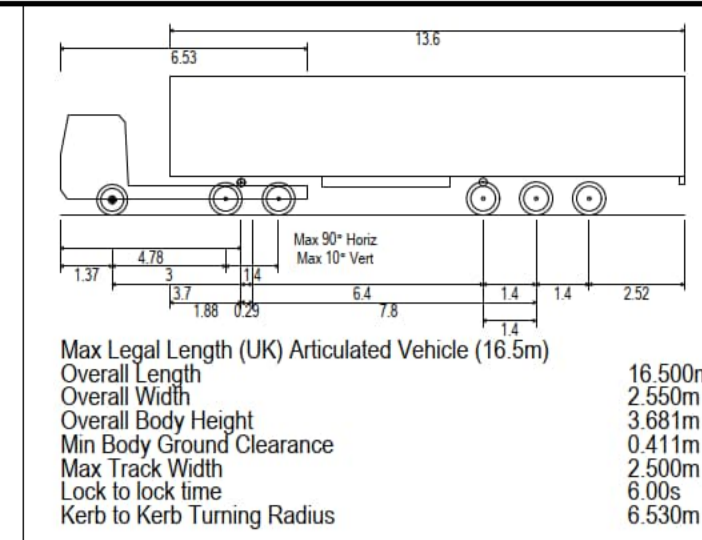

EGRESS MOVEMENTS TO BE BANKSPERSON CONTROLLED TO ENSURE THAT NO EGRESS MOVEMENT IS UNDERTAKEN AT THE SAME TIME AS ARRIVING CONSTRUCTION TRAFFIC.

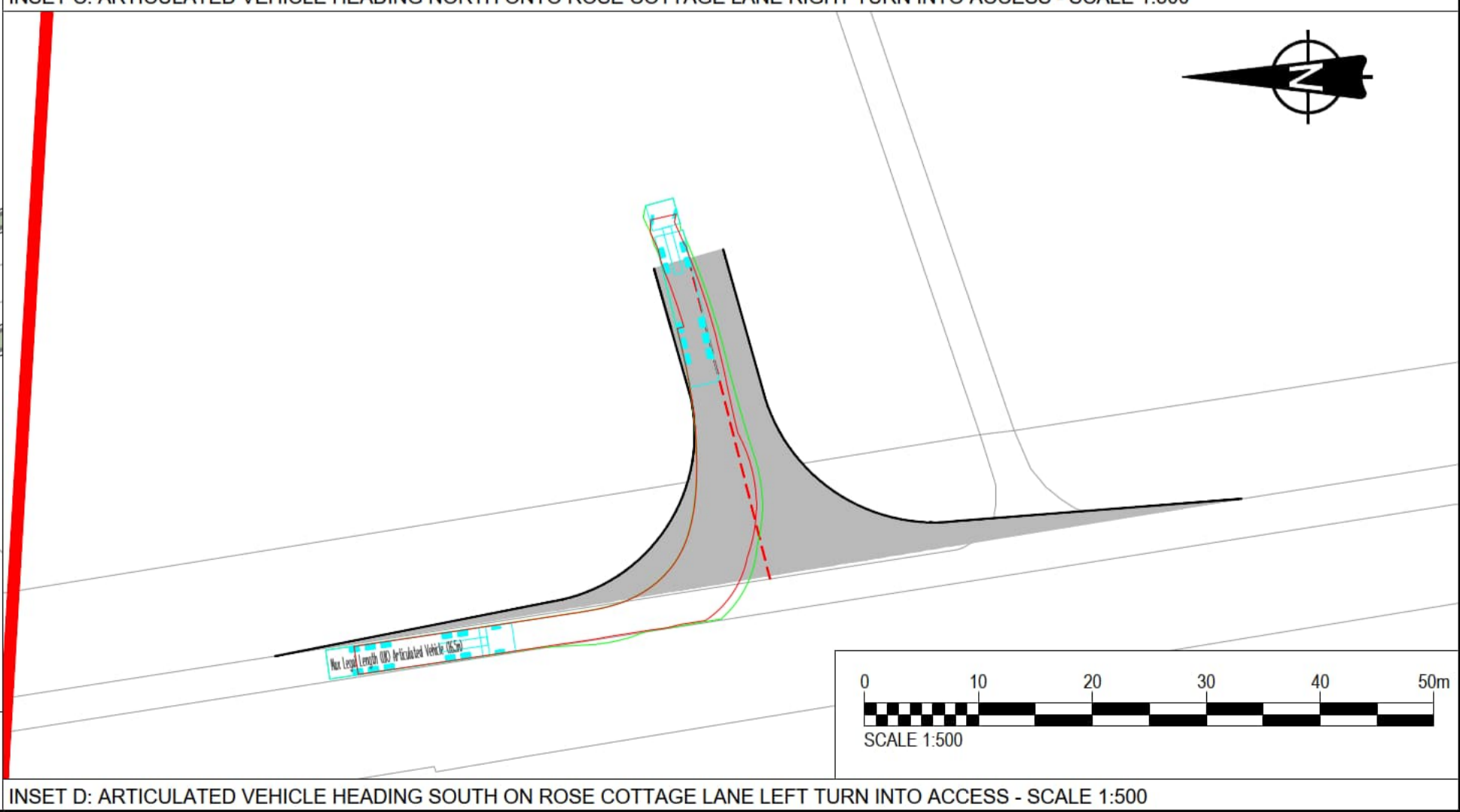
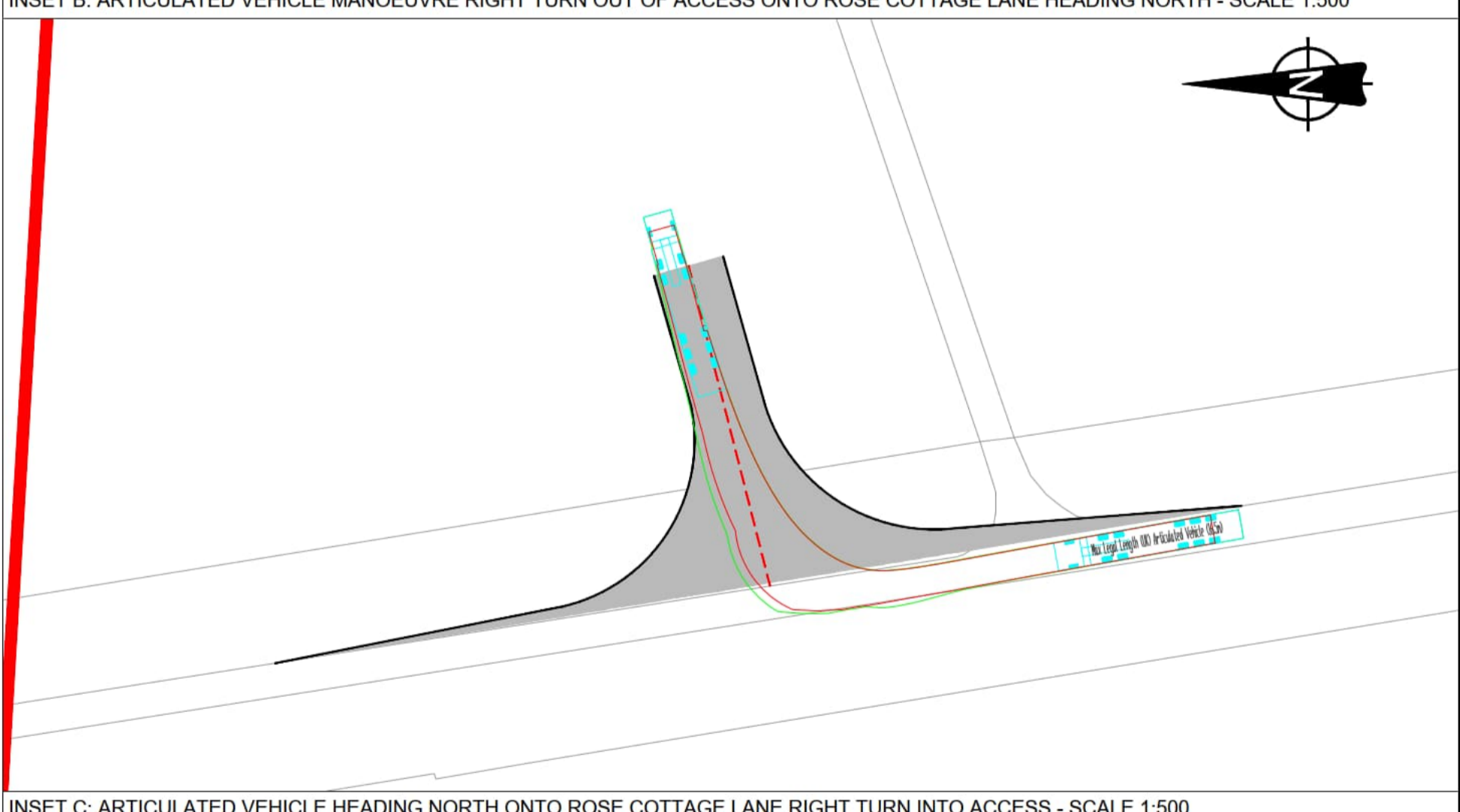
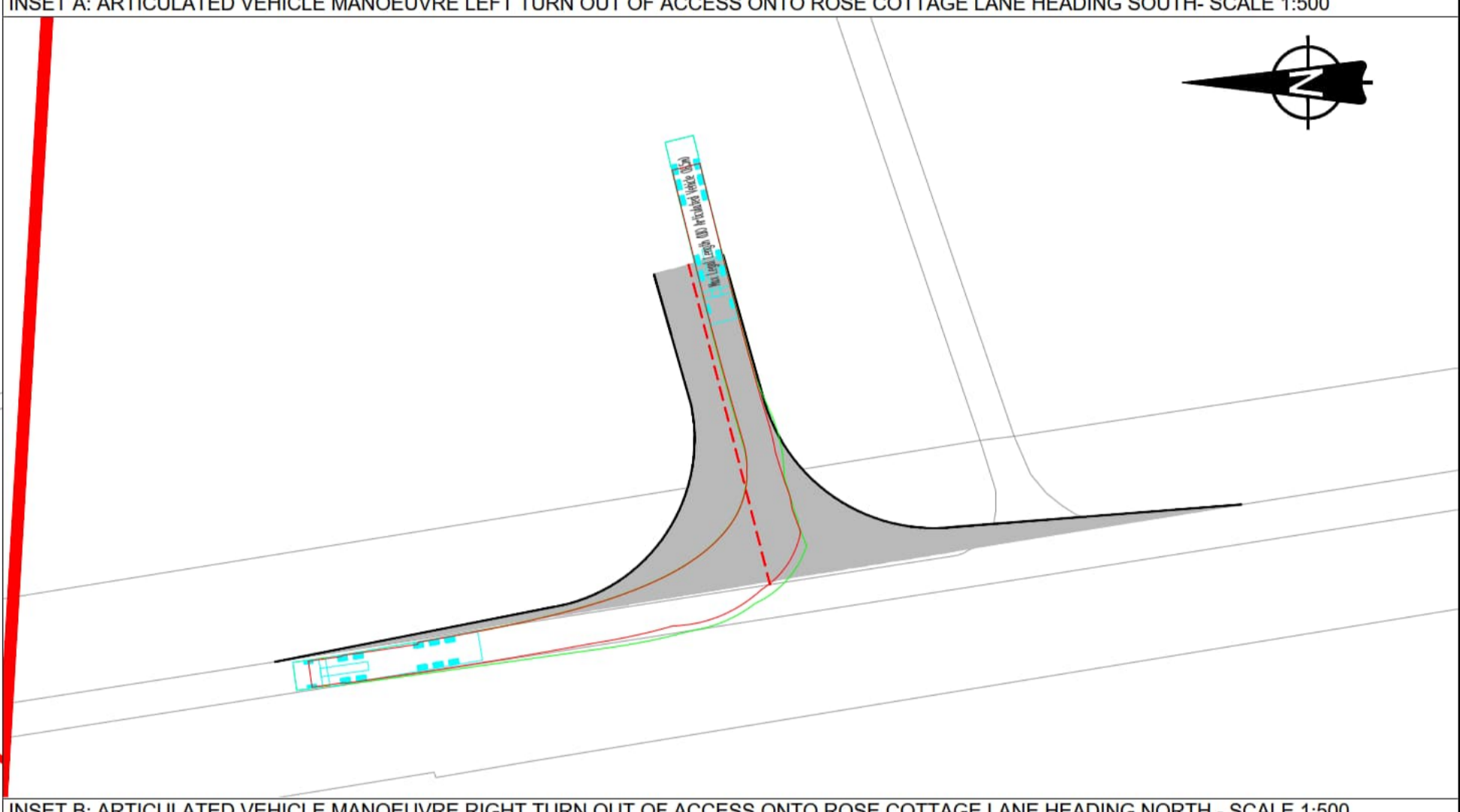
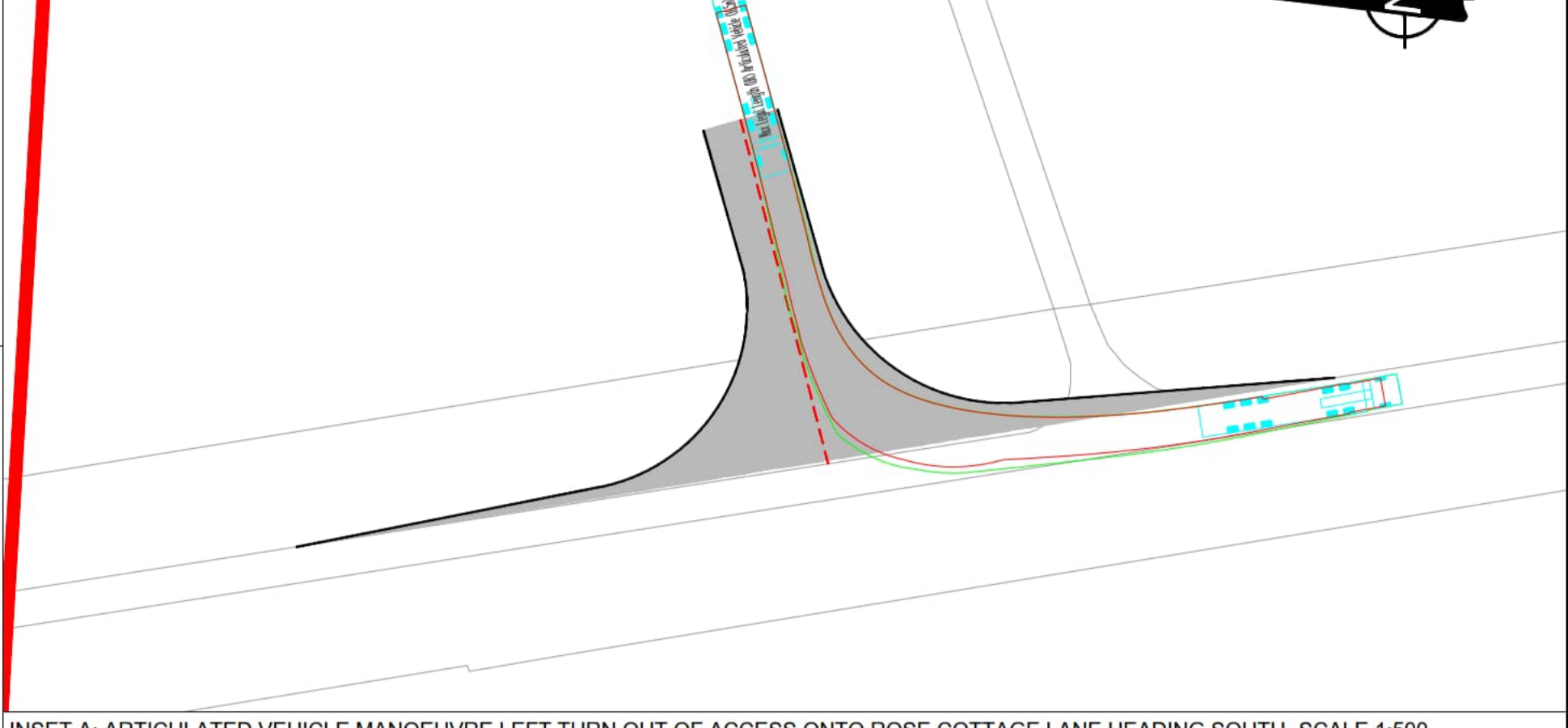
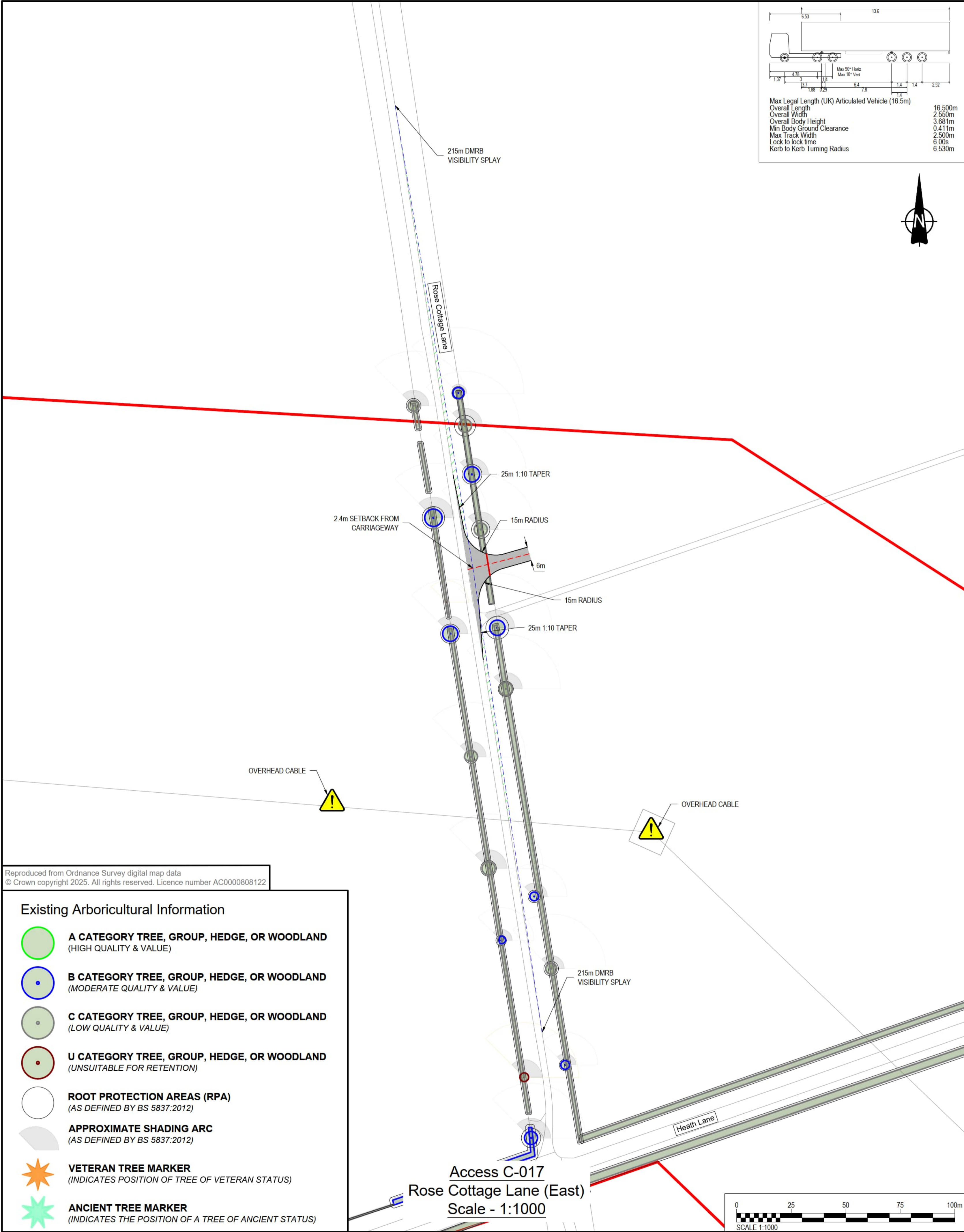

Reproduced from Ordnance Survey digital map data  
 © Crown copyright 2025. All rights reserved. Licence number AC0000808122

**Existing Arboricultural Information**

- A CATEGORY TREE, GROUP, HEDGE, OR WOODLAND** (HIGH QUALITY & VALUE)
- B CATEGORY TREE, GROUP, HEDGE, OR WOODLAND** (MODERATE QUALITY & VALUE)
- C CATEGORY TREE, GROUP, HEDGE, OR WOODLAND** (LOW QUALITY & VALUE)
- U CATEGORY TREE, GROUP, HEDGE, OR WOODLAND** (UNSUITABLE FOR RETENTION)
- ROOT PROTECTION AREAS (RPA)** (AS DEFINED BY BS 5837:2012)
- APPROXIMATE SHADING ARC** (AS DEFINED BY BS 5837:2012)
- VETERAN TREE MARKER** (INDICATES POSITION OF TREE OF VETERAN STATUS)
- ANCIENT TREE MARKER** (INDICATES THE POSITION OF A TREE OF ANCIENT STATUS)

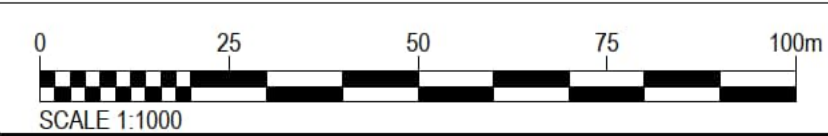

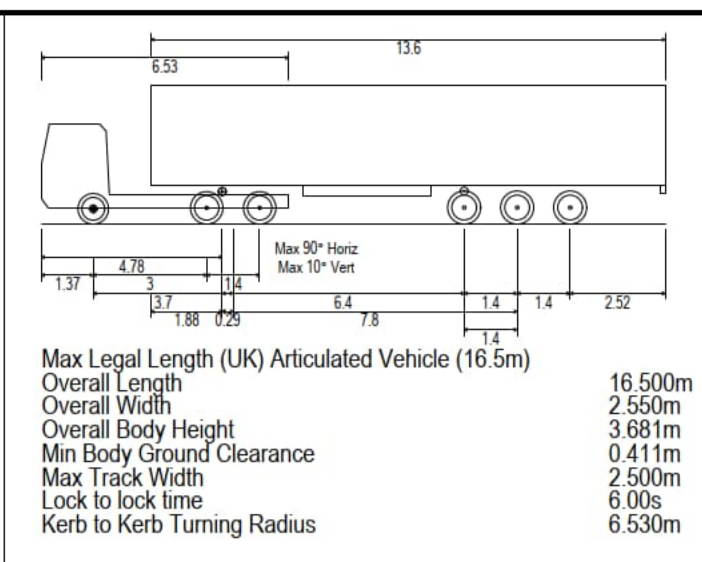
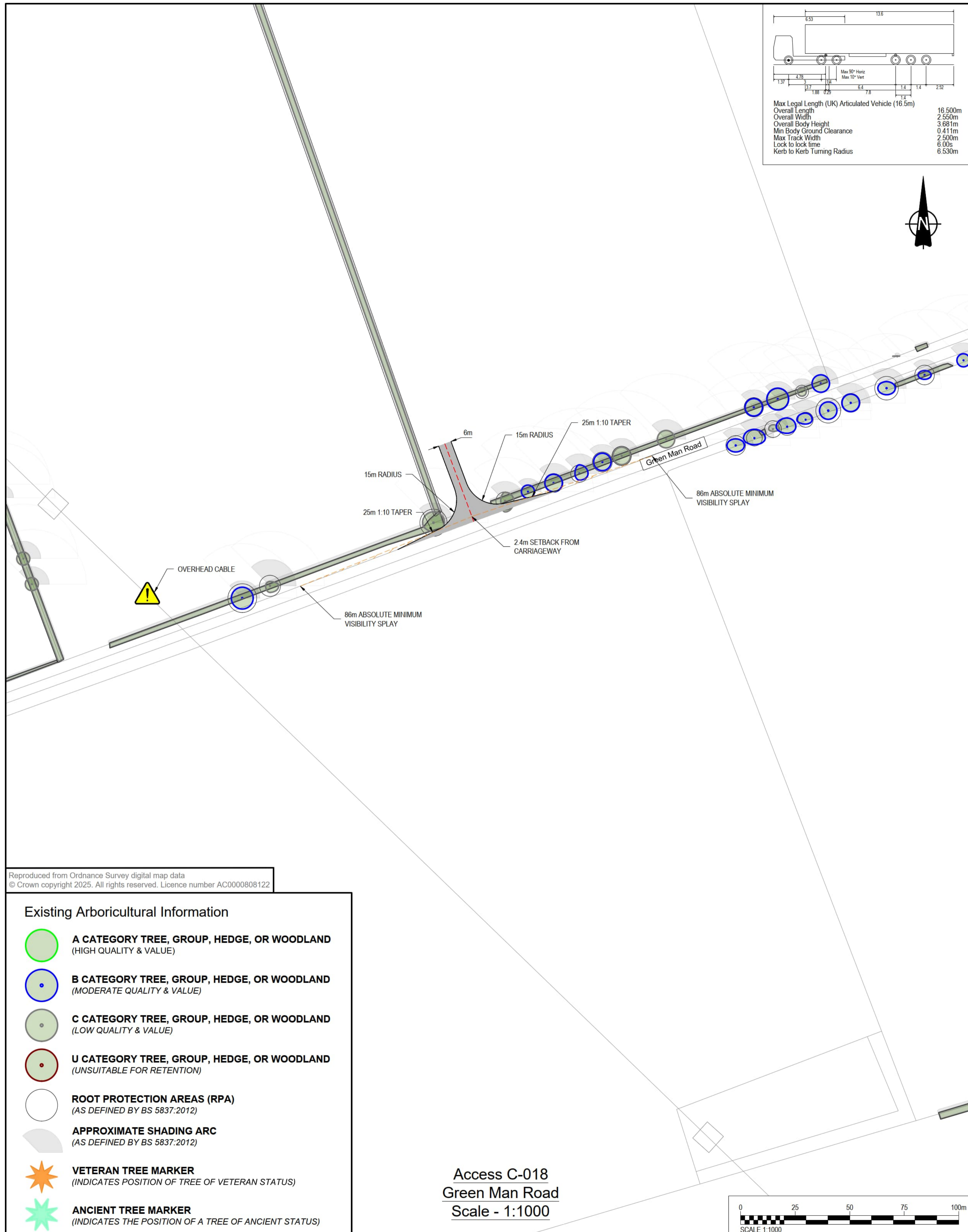

Reproduced from Ordnance Survey digital map data  
 © Crown copyright 2025. All rights reserved. Licence number AC0000808122

**Existing Arboricultural Information**

- A CATEGORY TREE, GROUP, HEDGE, OR WOODLAND**  
(HIGH QUALITY & VALUE)
- B CATEGORY TREE, GROUP, HEDGE, OR WOODLAND**  
(MODERATE QUALITY & VALUE)
- C CATEGORY TREE, GROUP, HEDGE, OR WOODLAND**  
(LOW QUALITY & VALUE)
- U CATEGORY TREE, GROUP, HEDGE, OR WOODLAND**  
(UNSUITABLE FOR RETENTION)
- ROOT PROTECTION AREAS (RPA)**  
(AS DEFINED BY BS 5837:2012)
- APPROXIMATE SHADING ARC**  
(AS DEFINED BY BS 5837:2012)
- VETERAN TREE MARKER**  
(INDICATES POSITION OF TREE OF VETERAN STATUS)
- ANCIENT TREE MARKER**  
(INDICATES THE POSITION OF A TREE OF ANCIENT STATUS)

**Access C-018**  
**Green Man Road**  
**Scale - 1:1000**

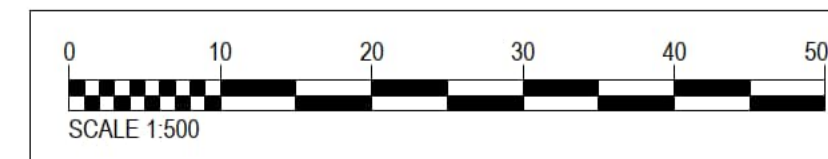
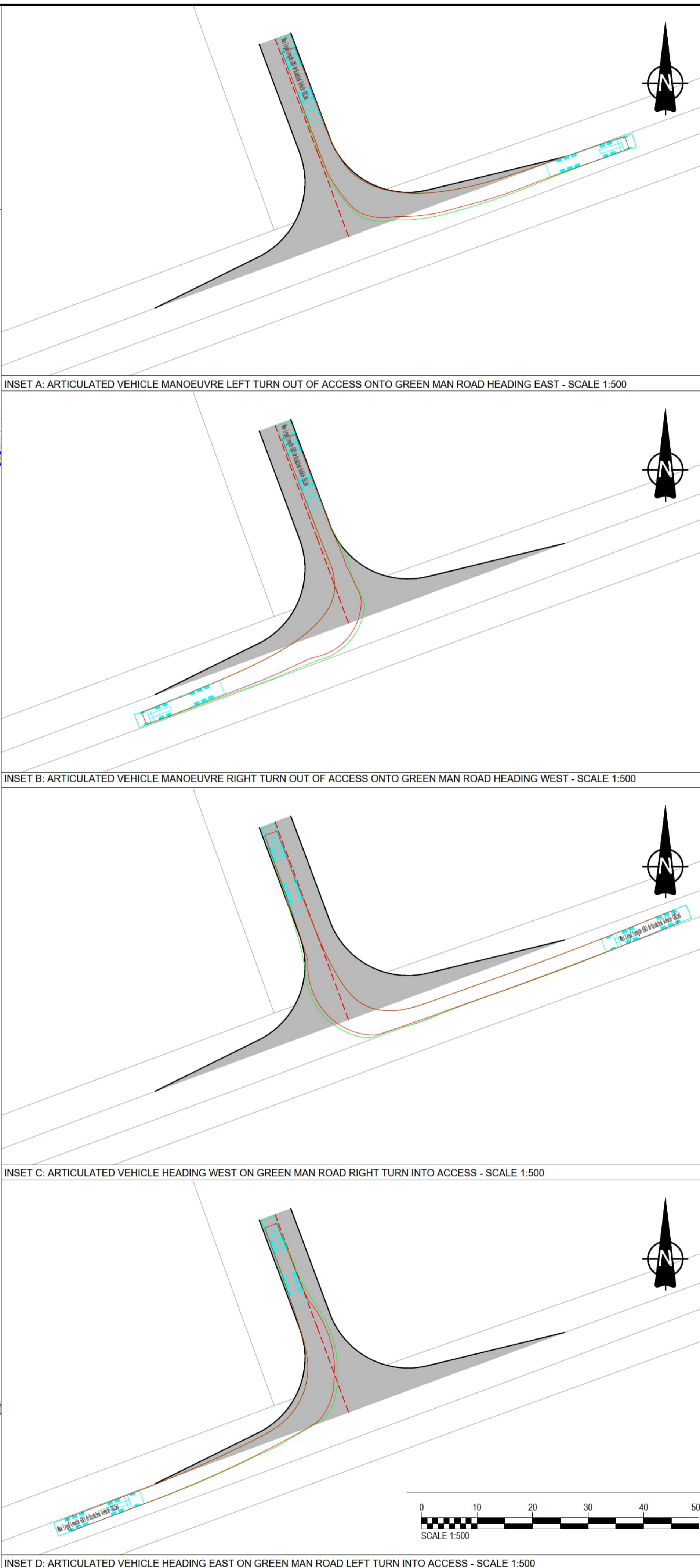
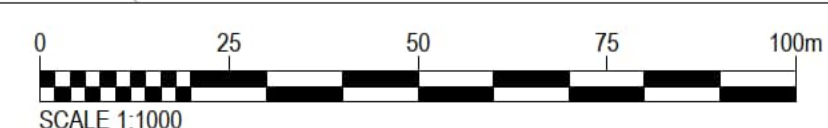

**PROJECT**  
**Fosse Green Energy**

**CLIENT**  
**Fosse Green Energy Ltd**

**CONSULTANT**  
**AECOM**

- NOTES**
- This drawing is to be read in conjunction with all other relevant documentation.
  - Do not scale from this drawing, use only printed dimensions.
  - All dimensions in meters, all chainages, levels and coordinates are in meters unless defined otherwise.
  - This drawing is to be read in conjunction with the project Health & Safety File for any identified potential risks.
  - Vegetation to be removed denotes any vegetation features (such as hedgerows) that need to be removed to provide the required junction visibility. Any verge grassland is not to be removed but managed by the relevant maintainer to a low height so as to not impact upon junction visibility.
  - Vehicle tracking shown is indicative only, and represents approximate vehicle size & arrangement for the design vehicle shown.
  - These plans should also be read in conjunction with ES Volume 6.2 Appendix 10-H Arboricultural Impact Assessment, for details on hedgerow removal and tree protection.
  - Junction Visibility for the access is based upon visibility parameters derived using 85th Percentile Speed Survey Data received on 1st December 2023.

- LEGEND**
- Extent of Access Footprint
  - DCO Site Boundary
  - Existing Public Rights of Way
  - Vehicle body
  - Vehicle body path
  - Vehicle load
  - Vehicle load path
  - Vehicle wheels path
  - Edge of road
  - Land not included in the DCO Site Boundary
  - Junction Visibility Absolute Min.
  - Vegetation to be removed Absolute Min. Vis Splay
  - Junction Visibility DMRB Min.
  - Vegetation to be removed DMRB Min. Vis Splay
  - Indicative Hedgerow Removal Absolute Min. Vis Splay
  - Indicative Hedgerow Removal for Bellmouth Access
  - Approximate Structure Footprint
  - Health and Safety Risk Identifier

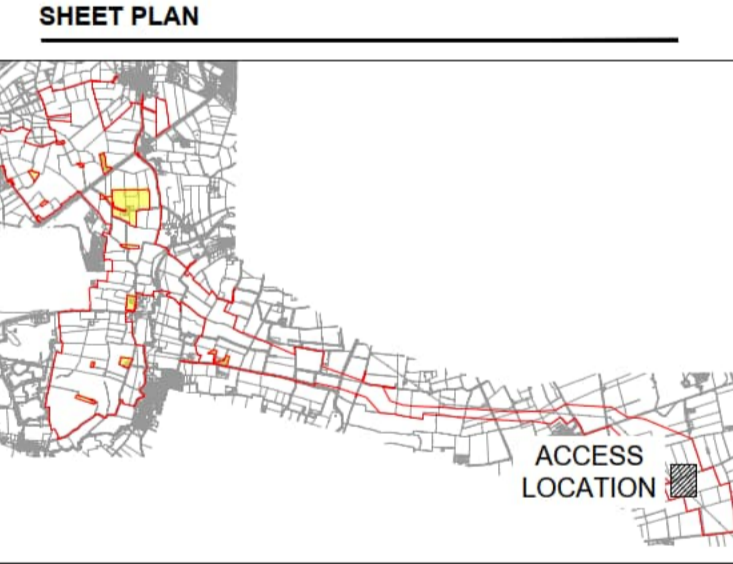

**ISSUE/REVISION**

NO.	DATE	DESCRIPTION
P01	17/07/2025	DCO SUBMISSION

**LEGISLATION**  
 Regulation 5(2)(k) Infrastructure Planning (Applications: Prescribed Forms and Procedure) Regulations 2009

**ISSUE PURPOSE**  
 DCO SUBMISSION

FIGURE NUMBER	REV.
ACCESS C-018	01

**DOCUMENT REFERENCE**  
 EN010154/APP/7.18

This drawing has been prepared for the use of AECOM's client. It may not be used, modified, reproduced or relied upon by third parties, except as agreed by AECOM or as required by law. AECOM accepts no responsibility, and denies any liability whatsoever, to any party that uses or relies on this drawing without AECOM's express written consent. Do not scale this document.

- NOTES**
- This drawing is to be read in conjunction with all other relevant documentation.
  - Do not scale from this drawing, use only printed dimensions.
  - All dimensions in meters, all chainages, levels and coordinates are in meters unless defined otherwise.
  - This drawing is to be read in conjunction with the project Health & Safety File for any identified potential risks.
  - Vegetation to be removed denotes any vegetation features (such as hedgerows) that need to be removed to provide the required junction visibility. Any verge grassland is not to be removed but managed by the relevant maintainer to a low height so as not to impact upon junction visibility.
  - Vehicle tracking shown is indicative only, and represents approximate vehicle size & arrangement for the design vehicle shown.
  - These plans should also be read in conjunction with ES Volume 6.2 Appendix 10-H Arboricultural Impact Assessment, for details on hedgerow removal and tree protection.
  - Junction Visibility for the access is based upon visibility parameters derived using 85th Percentile Speed Survey Data received on 1st December 2023.

- LEGEND**
- Extent of Access Footprint
  - DCO Site Boundary
  - Existing Public Rights of Way
  - Vehicle body
  - Vehicle body path
  - Vehicle load
  - Vehicle load path
  - Vehicle wheels path
  - Edge of road
  - Land not included in the DCO Site Boundary
  - Junction Visibility Absolute Min.
  - Vegetation to be removed Absolute Min. Vis Splay
  - Junction Visibility DMRB Min.
  - Vegetation to be removed DMRB Min. Vis Splay
  - Indicative Hedgerow Removal Absolute Min. Vis Splay
  - Indicative Hedgerow Removal for Bellmouth Access
  - Approximate Structure Footprint
  - Health and Safety Risk Identifier

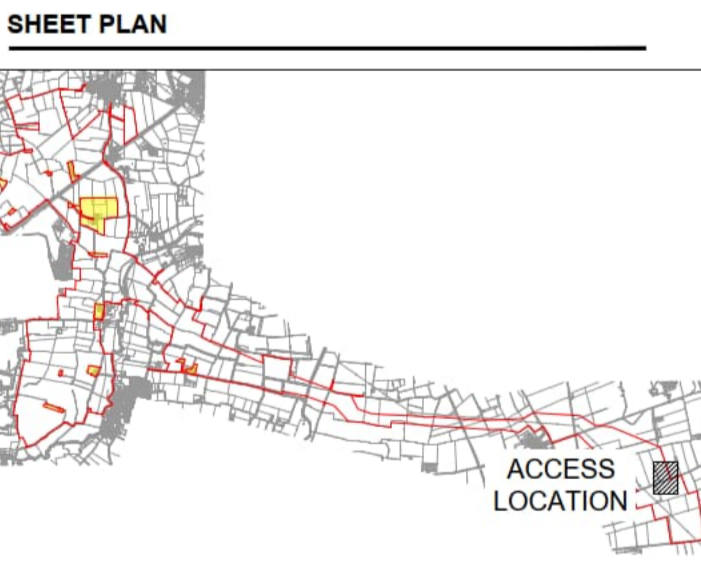

**ISSUE/REVISION**

NO.	DATE	DESCRIPTION
P01	17/07/2025	DCO SUBMISSION

**LEGISLATION**  
 Regulation 5(2)(k) Infrastructure Planning (Applications: Prescribed Forms and Procedure) Regulations 2009

**ISSUE PURPOSE**  
 DCO SUBMISSION

FIGURE NUMBER	REV.
ACCESS C-019	01

**DOCUMENT REFERENCE**  
 EN010154/APP/7.18

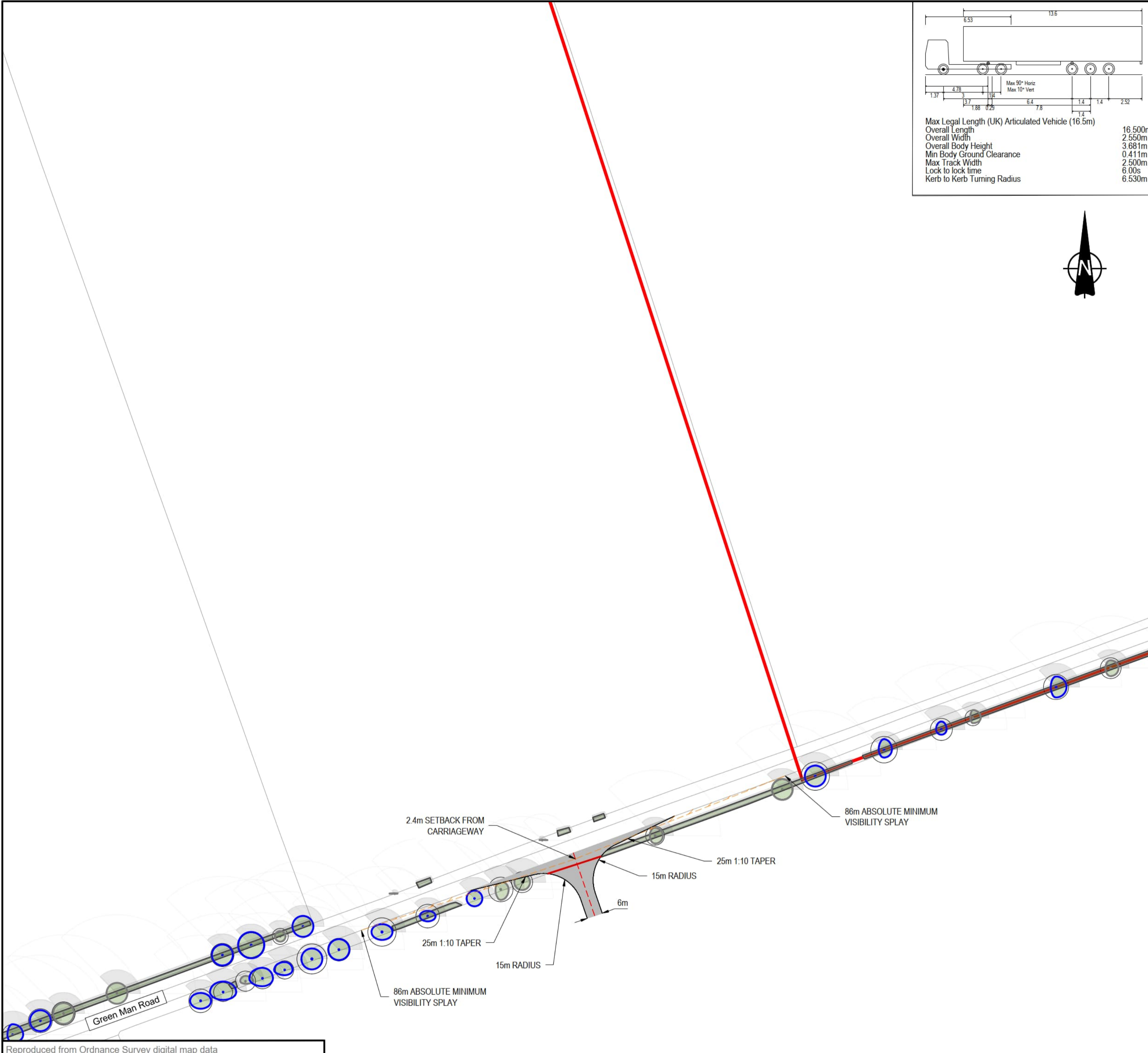
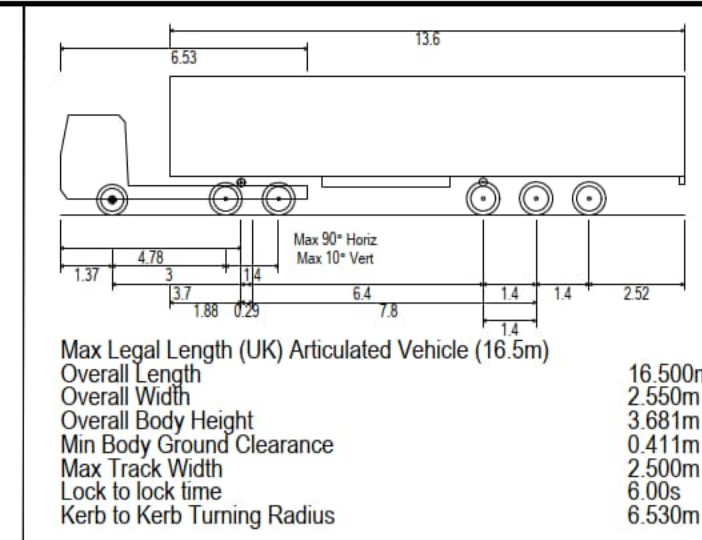

**Existing Arboricultural Information**

- A CATEGORY TREE, GROUP, HEDGE, OR WOODLAND** (HIGH QUALITY & VALUE)
- B CATEGORY TREE, GROUP, HEDGE, OR WOODLAND** (MODERATE QUALITY & VALUE)
- C CATEGORY TREE, GROUP, HEDGE, OR WOODLAND** (LOW QUALITY & VALUE)
- U CATEGORY TREE, GROUP, HEDGE, OR WOODLAND** (UNSUITABLE FOR RETENTION)
- ROOT PROTECTION AREAS (RPA)** (AS DEFINED BY BS 5837:2012)
- APPROXIMATE SHADING ARC** (AS DEFINED BY BS 5837:2012)
- VETERAN TREE MARKER** (INDICATES POSITION OF TREE OF VETERAN STATUS)
- ANCIENT TREE MARKER** (INDICATES THE POSITION OF A TREE OF ANCIENT STATUS)

**Access C-019**  
**Green Man Road (East)**  
**Scale - 1:1000**

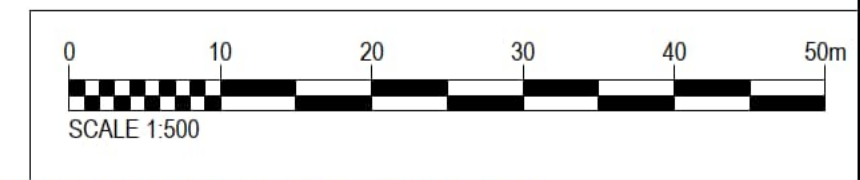
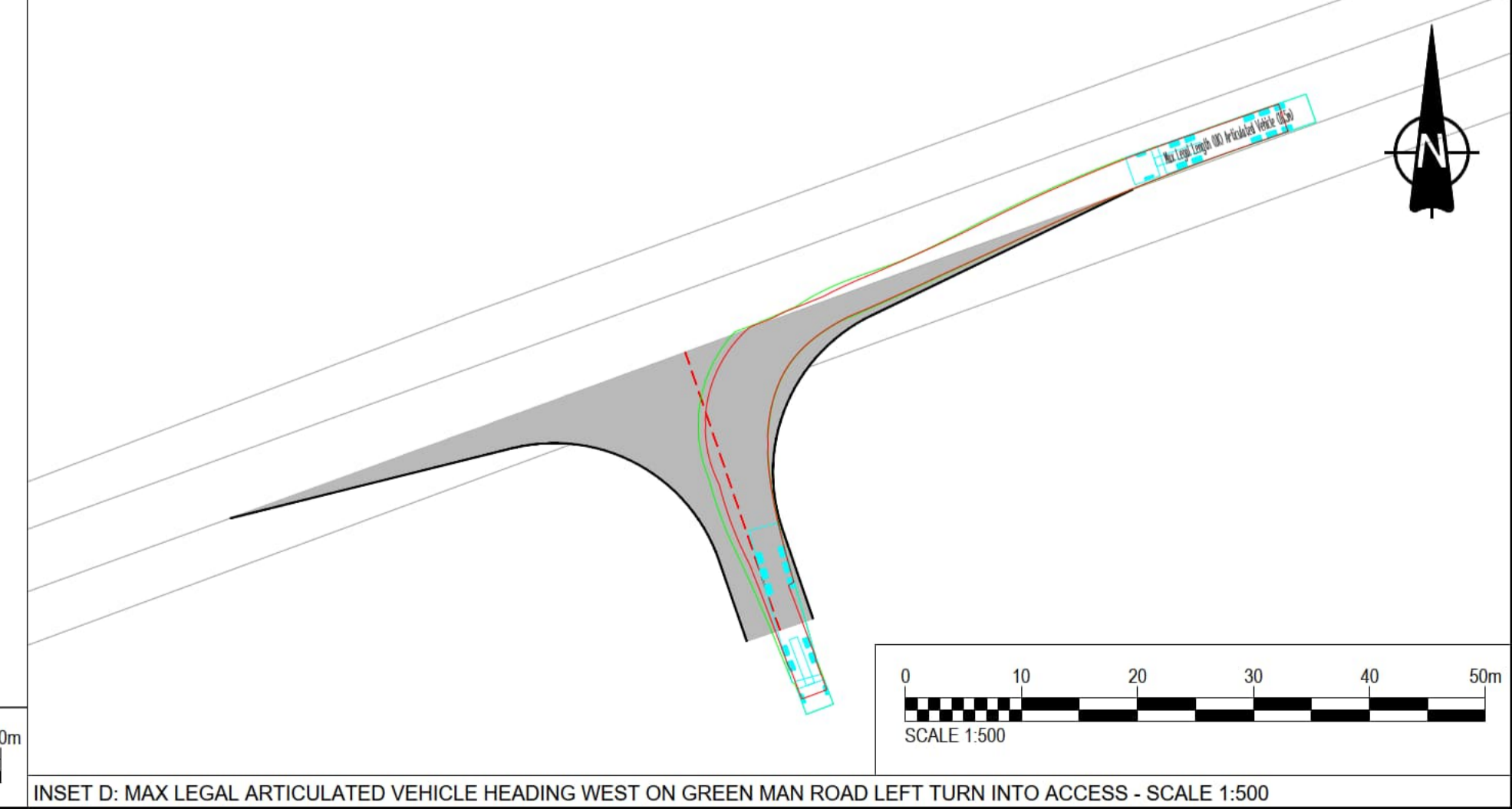
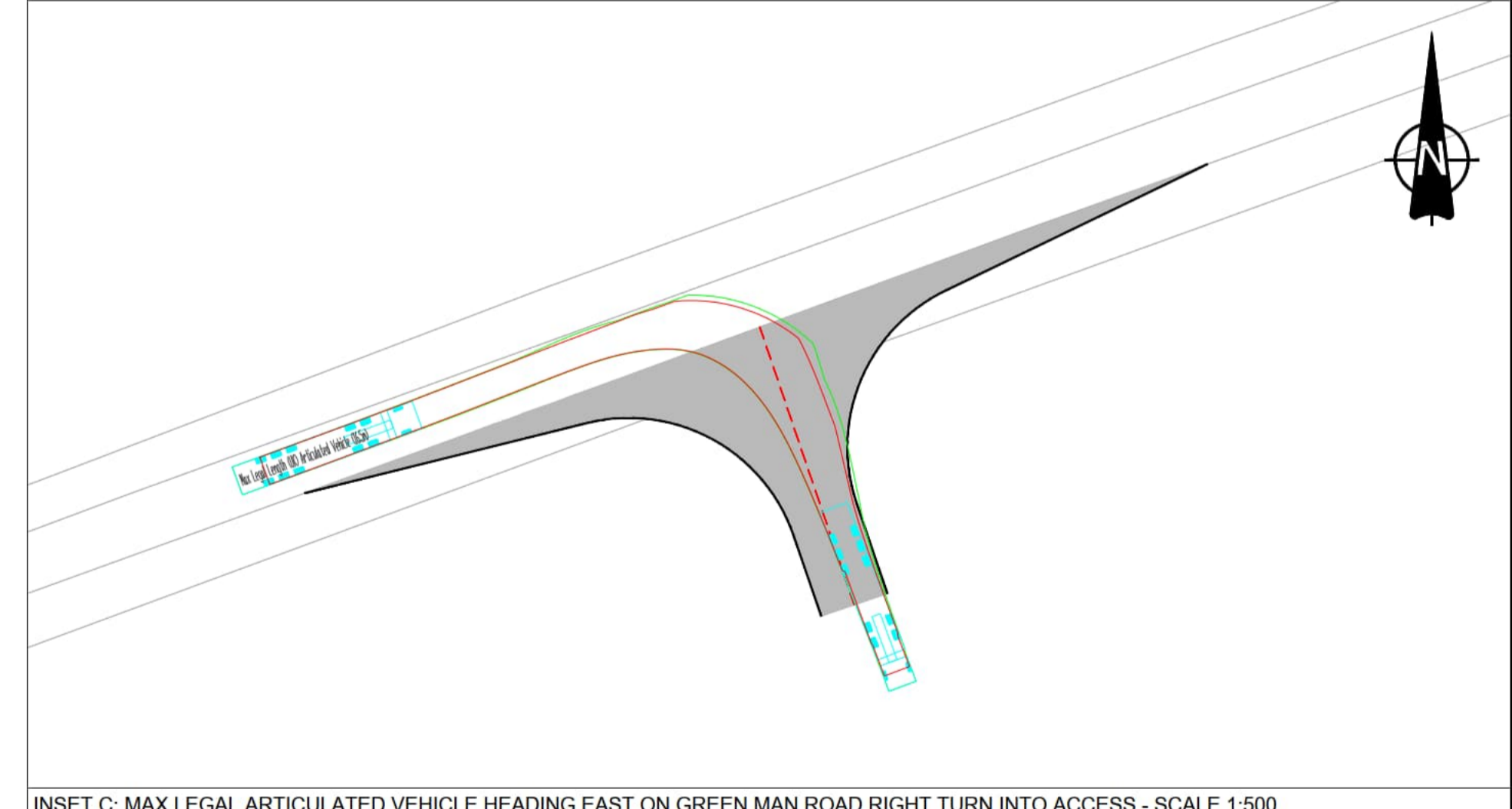
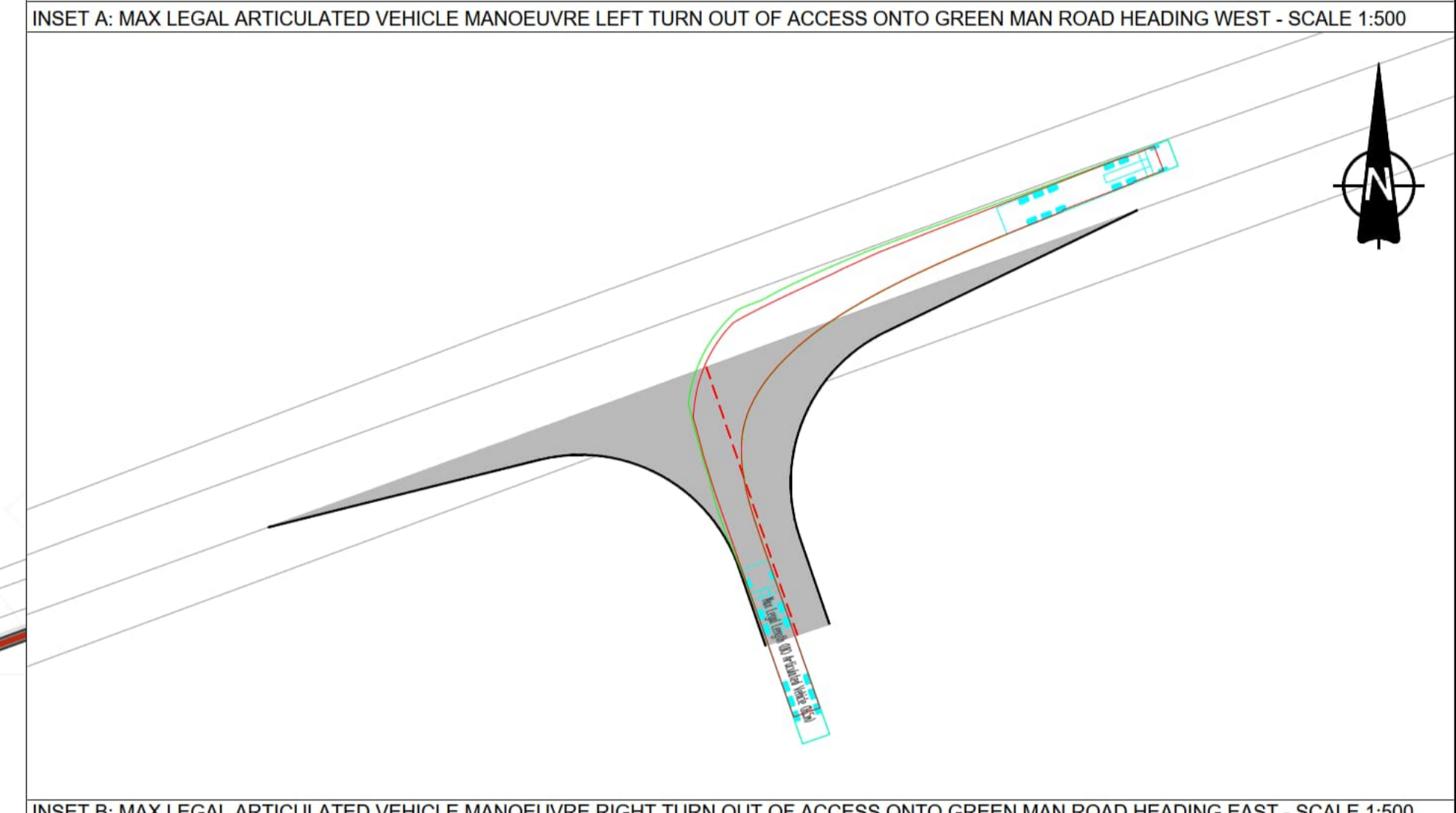
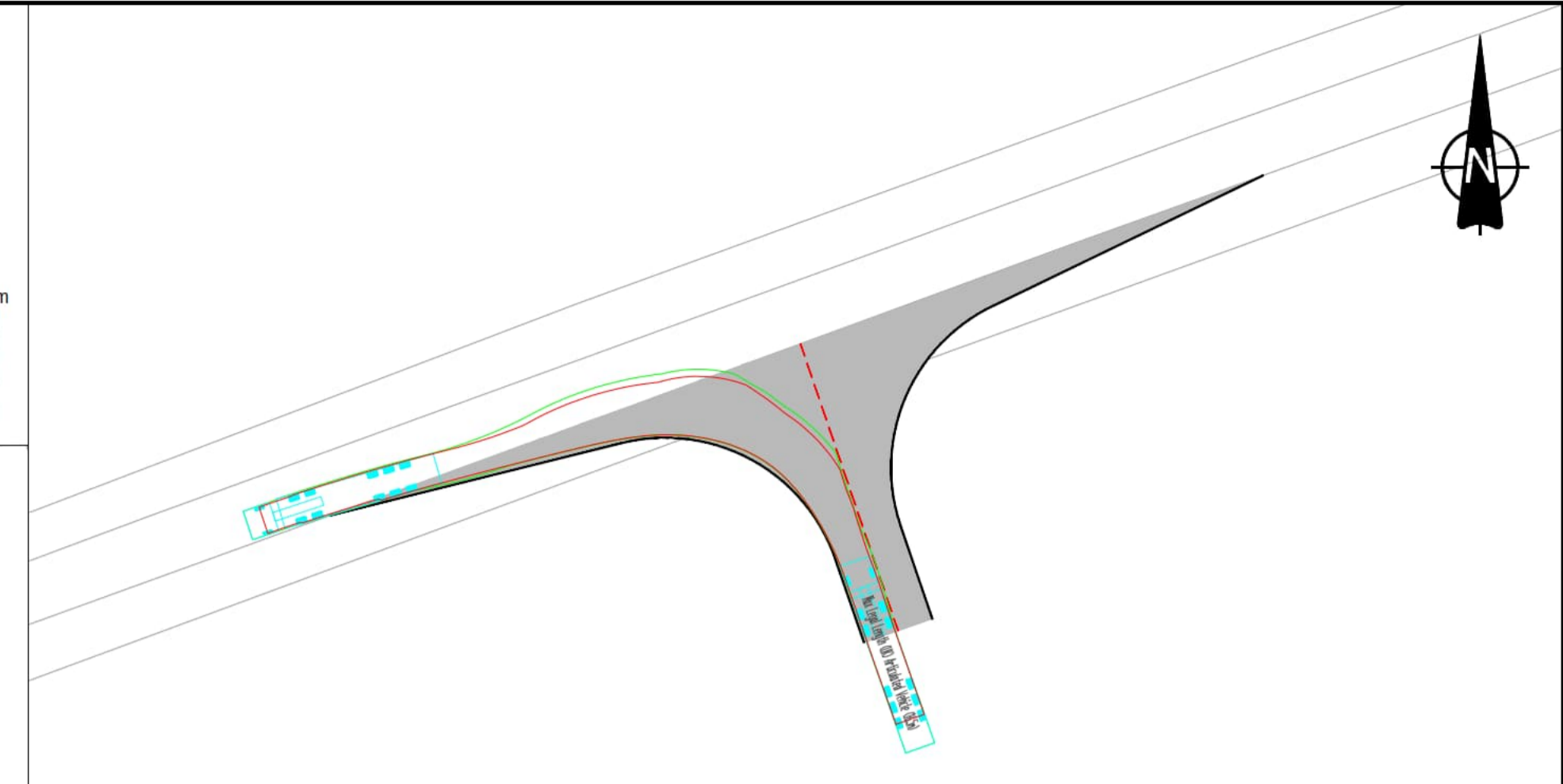
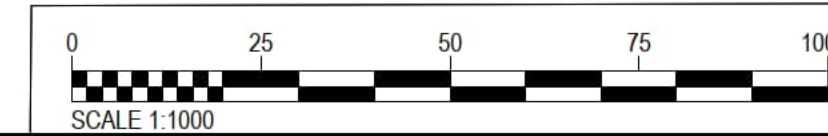

This drawing has been prepared for the use of AECOM's client. It may not be used, modified, reproduced or relied upon by third parties, except as agreed by AECOM or as required by law. AECOM accepts no responsibility, and denies any liability whatsoever, to any party that uses or relies on this drawing without AECOM's express written consent. Do not scale this document.

- NOTES**
- This drawing is to be read in conjunction with all other relevant documentation.
  - Do not scale from this drawing, use only printed dimensions.
  - All dimensions in meters, all chainages, levels and coordinates are in meters unless defined otherwise.
  - This drawing is to be read in conjunction with the project Health & Safety File for any identified potential risks.
  - Vegetation to be removed denotes any vegetation features (such as hedgerows) that need to be removed to provide the required junction visibility. Any verge grassland is not to be removed but managed by the relevant maintainer to a low height so as to not impact upon junction visibility.
  - Vehicle tracking shown is indicative only, and represents approximate vehicle size & arrangement for the design vehicle shown.
  - These plans should also be read in conjunction with ES Volume 6.2 Appendix 10-H Arboricultural Impact Assessment, for details on hedgerow removal and tree protection.
  - Junction Visibility for the access is based upon visibility parameters derived using 85th Percentile Speed Survey data received on 1st December 2023.

- LEGEND**
- Extent of Access Footprint
  - DCO Site Boundary
  - Existing Public Rights of Way
  - Vehicle body
  - Vehicle body path
  - Vehicle load
  - Vehicle load path
  - Vehicle wheels path
  - Edge of road
  - Land not included in the DCO Site Boundary
  - Junction Visibility Absolute Min.
  - Vegetation to be removed Absolute Min. Vis Splay
  - Junction Visibility DMRB Min.
  - Vegetation to be removed DMRB Min. Vis Splay
  - Indicative Hedgerow Removal Absolute Min. Vis Splay
  - Indicative Hedgerow Removal for Bellmouth Access
  - Approximate Structure Footprint
  - Health and Safety Risk Identifier



**ISSUE/REVISION**

NO	DATE	DESCRIPTION
P01	17/07/2025	DCO SUBMISSION

**LEGISLATION**  
 Regulation 5(2)(k) Infrastructure Planning (Applications: Prescribed Forms and Procedure) Regulations 2009

**ISSUE PURPOSE**  
 DCO SUBMISSION

FIGURE NUMBER	REV.
ACCESS C-020	01

**DOCUMENT REFERENCE**  
 EN10154/APP/7.18

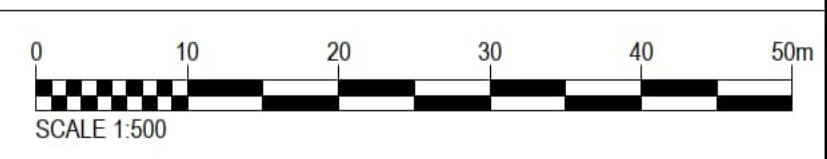
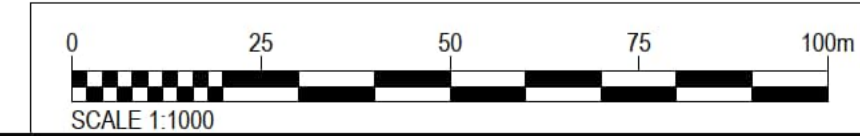
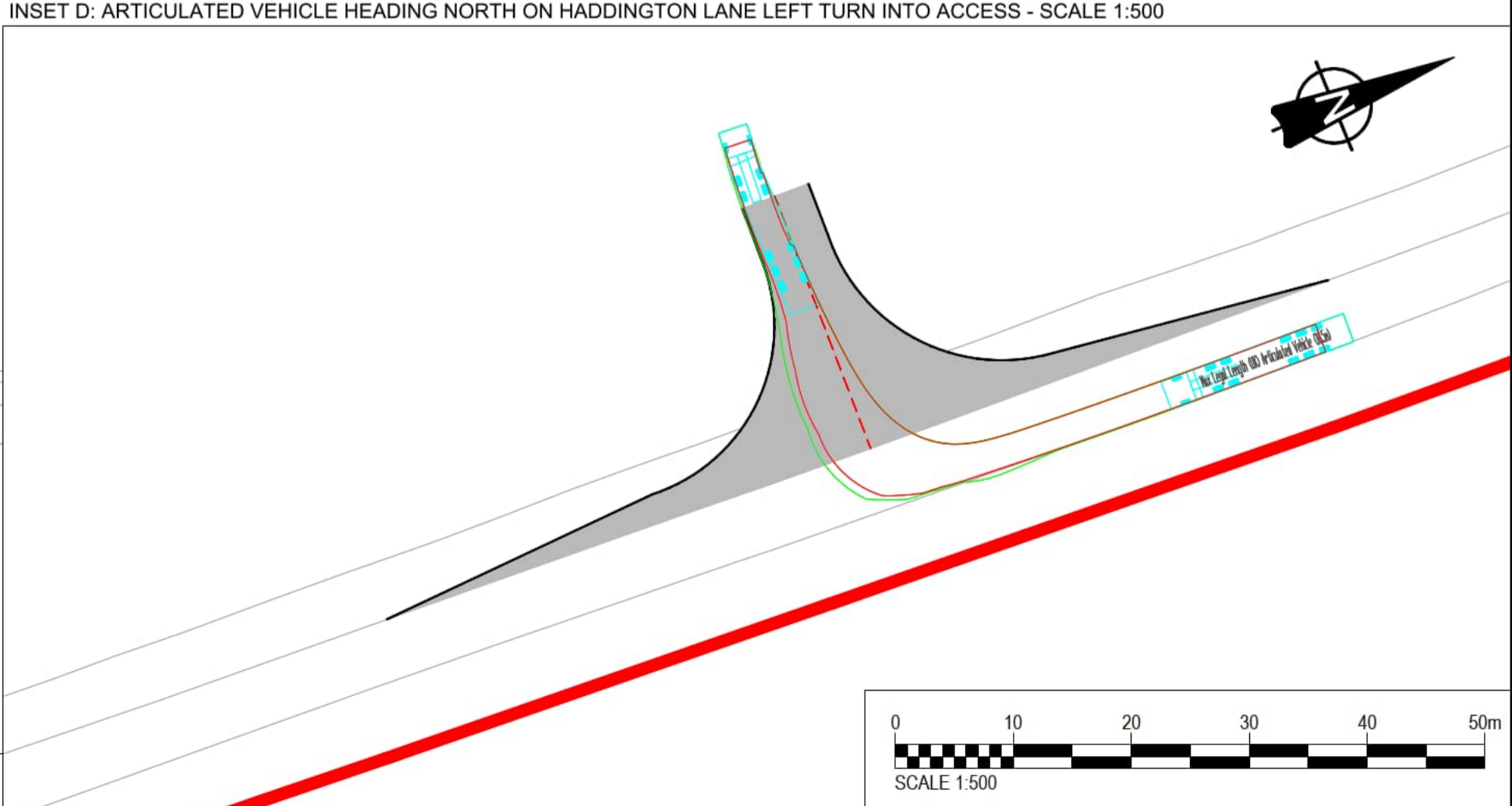
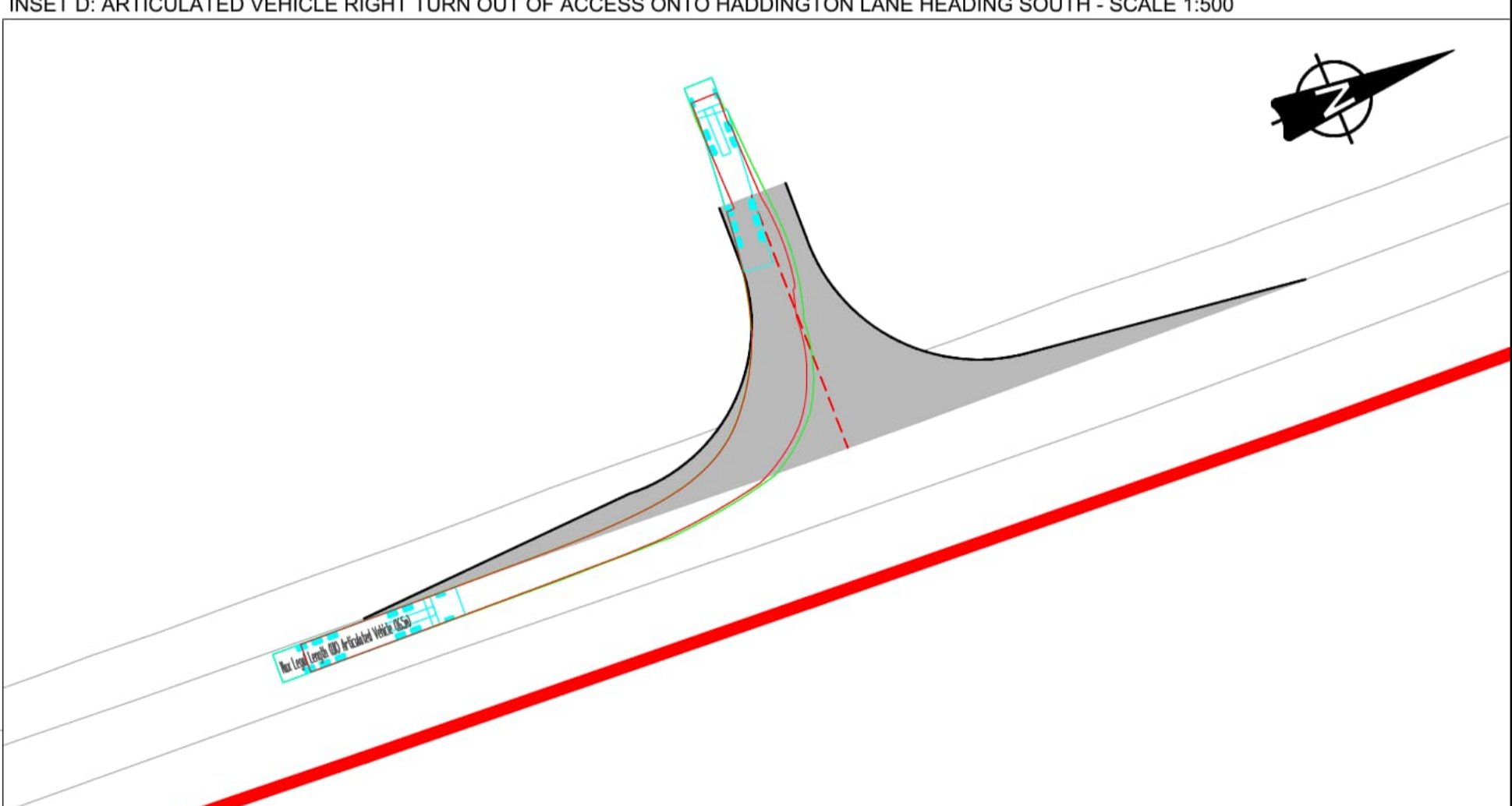
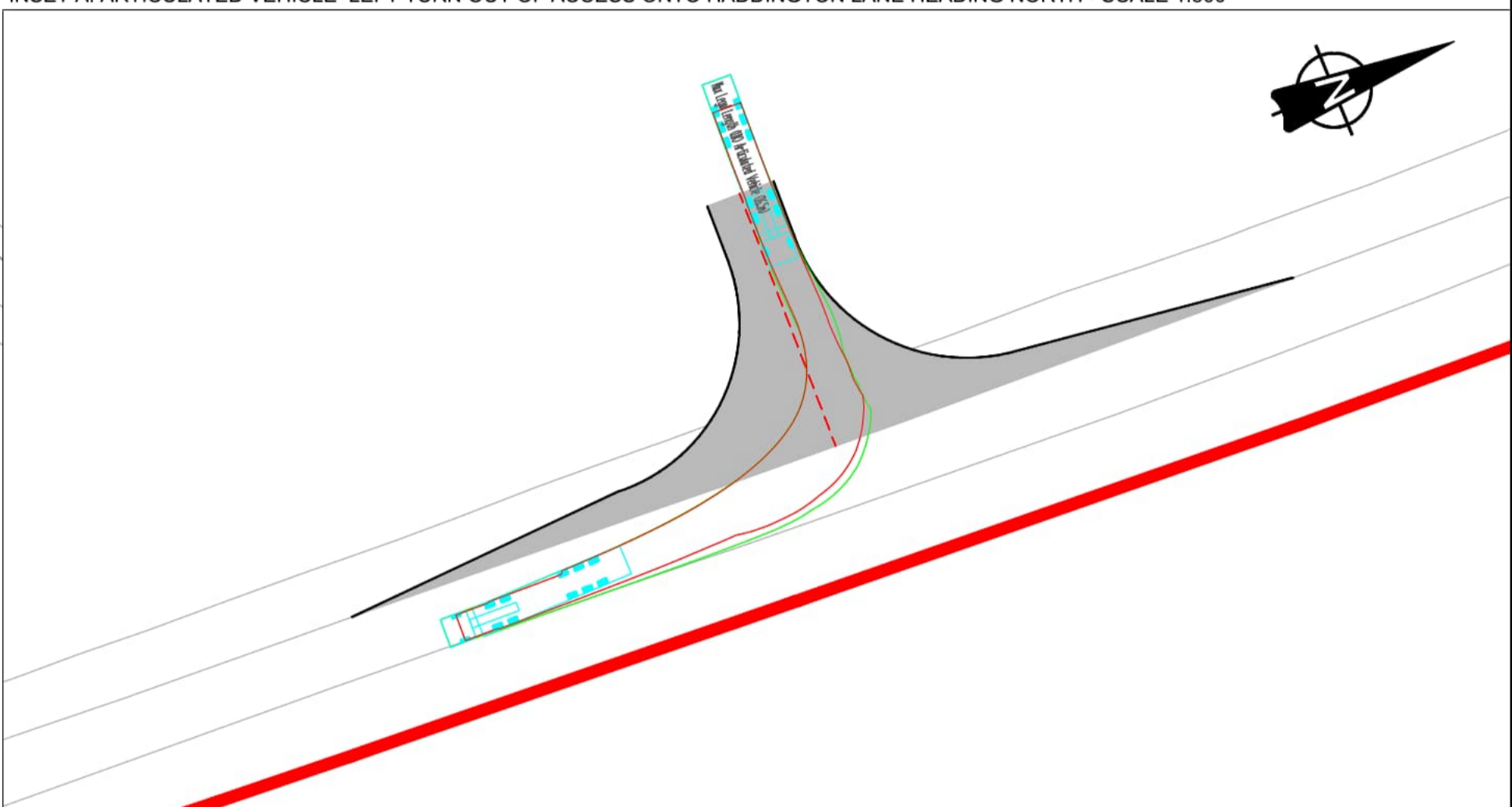
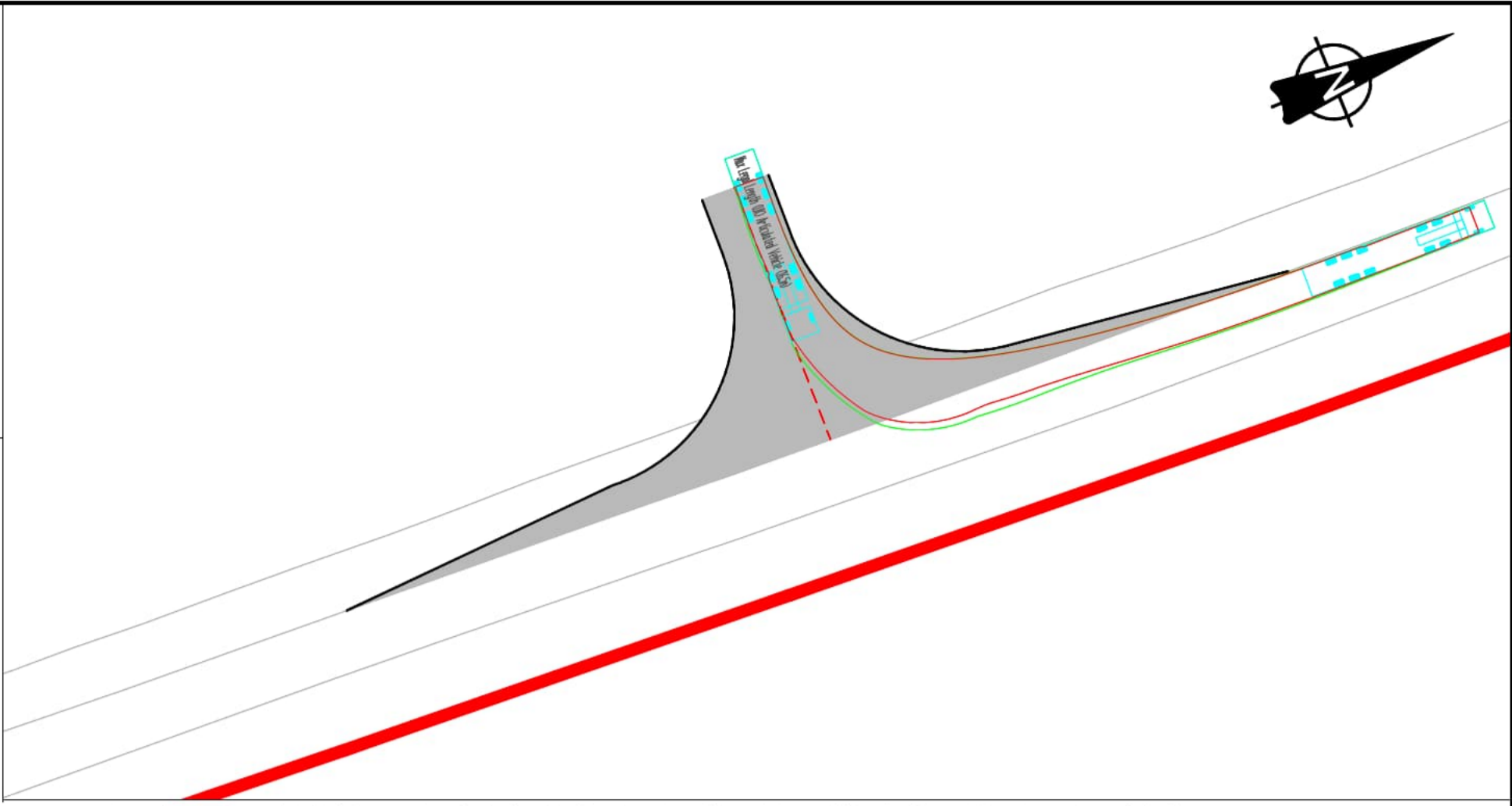
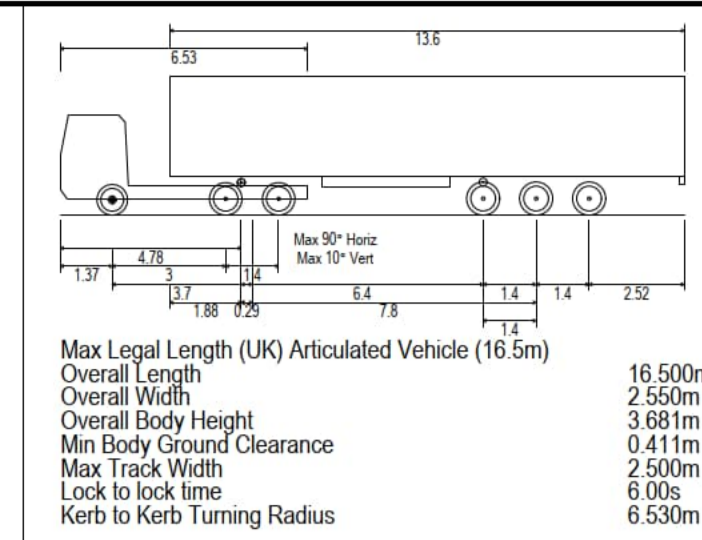
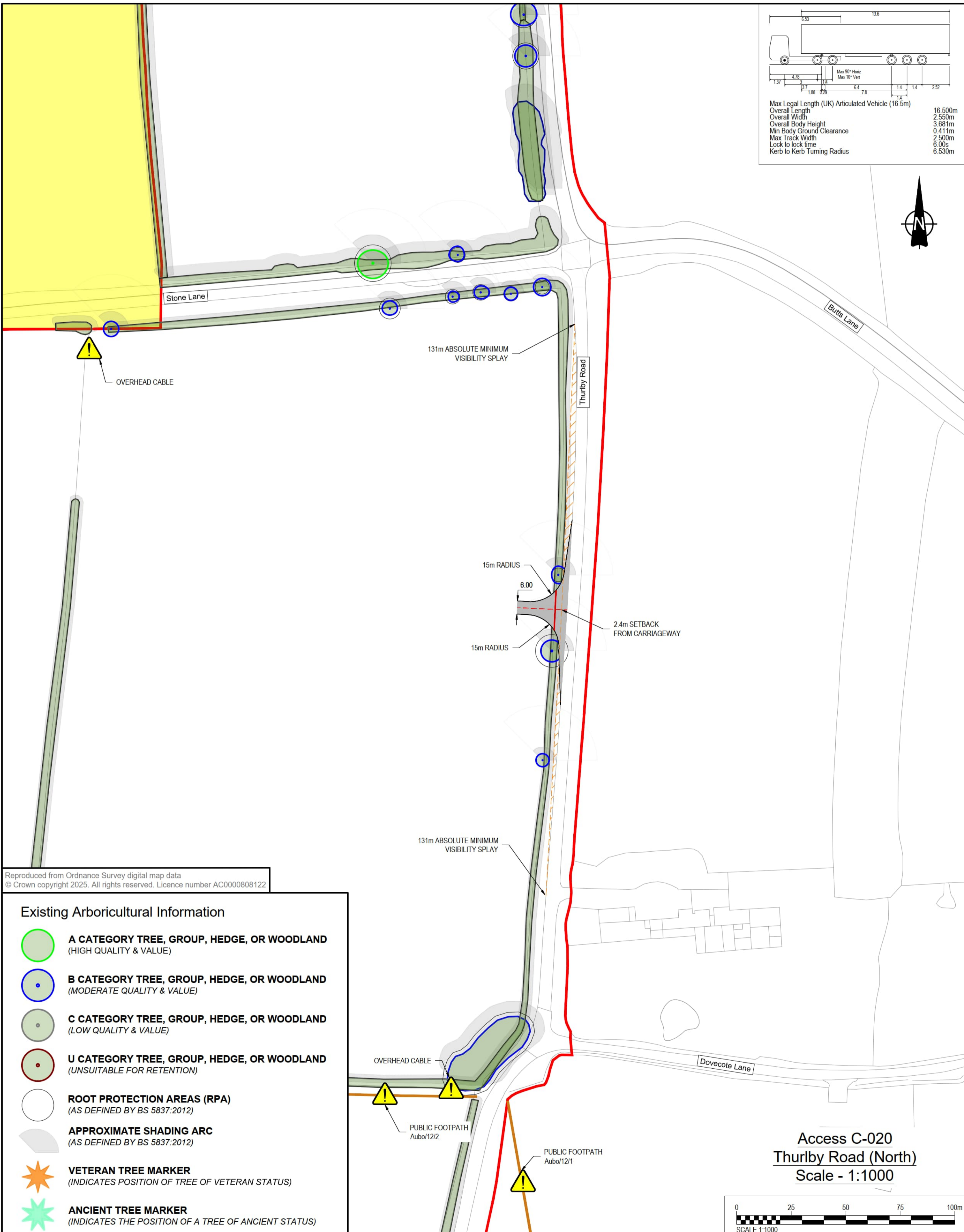

- Existing Arboricultural Information**
- A CATEGORY TREE, GROUP, HEDGE, OR WOODLAND** (HIGH QUALITY & VALUE)
  - B CATEGORY TREE, GROUP, HEDGE, OR WOODLAND** (MODERATE QUALITY & VALUE)
  - C CATEGORY TREE, GROUP, HEDGE, OR WOODLAND** (LOW QUALITY & VALUE)
  - U CATEGORY TREE, GROUP, HEDGE, OR WOODLAND** (UNSUITABLE FOR RETENTION)
  - ROOT PROTECTION AREAS (RPA)** (AS DEFINED BY BS 5837:2012)
  - APPROXIMATE SHADING ARC** (AS DEFINED BY BS 5837:2012)
  - VETERAN TREE MARKER** (INDICATES POSITION OF TREE OF VETERAN STATUS)
  - ANCIENT TREE MARKER** (INDICATES THE POSITION OF A TREE OF ANCIENT STATUS)

This drawing has been prepared for the use of AECOM's client. It may not be used, modified, reproduced or relied upon by third parties, except as agreed by AECOM or as required by law. AECOM accepts no responsibility, and denies any liability whatsoever, to any party that uses or relies on this drawing without AECOM's express written consent. Do not scale this document.



**PROJECT**  
 Fosse Green Energy

**CLIENT**  
 Fosse Green Energy Ltd

**CONSULTANT**  
 AECOM

- NOTES**
- This drawing is to be read in conjunction with all other relevant documentation.
  - Do not scale from this drawing, use only printed dimensions.
  - All dimensions in meters, all chainages, levels and coordinates are in meters unless defined otherwise.
  - This drawing is to be read in conjunction with the project Health & Safety File for any identified potential risks.
  - Vegetation to be removed denotes any vegetation features (such as hedgerows) that need to be removed to provide the required junction visibility. Any verge grassland is not to be removed but managed by the relevant maintainer to a low height so as to not impact upon junction visibility.
  - Vehicle tracking shown is indicative only, and represents approximate vehicle size & arrangement for the design vehicle shown.
  - These plans should also be read in conjunction with ES Volume 6.2 Appendix 10-H Arboricultural Impact Assessment, for details on hedgerow removal and tree protection.
  - Junction Visibility for the access is based on DMRB CD109, Table 2.10.

- LEGEND**
- Extent of Access Footprint
  - DCO Site Boundary
  - Existing Public Rights of Way
  - Vehicle body
  - Vehicle body path
  - Vehicle load
  - Vehicle load path
  - Vehicle wheels path
  - Edge of road
  - Land not included in the DCO Site Boundary
  - Junction Visibility Absolute Min.
  - Vegetation to be removed Absolute Min. Vis Splay
  - Junction Visibility DMRB Min.
  - Vegetation to be removed DMRB Min. Vis Splay
  - Indicative Hedgerow Removal Absolute Min. Vis Splay
  - Indicative Hedgerow Removal for Bellmouth Access
  - Approximate Structure Footprint
  - Health and Safety Risk Identifier

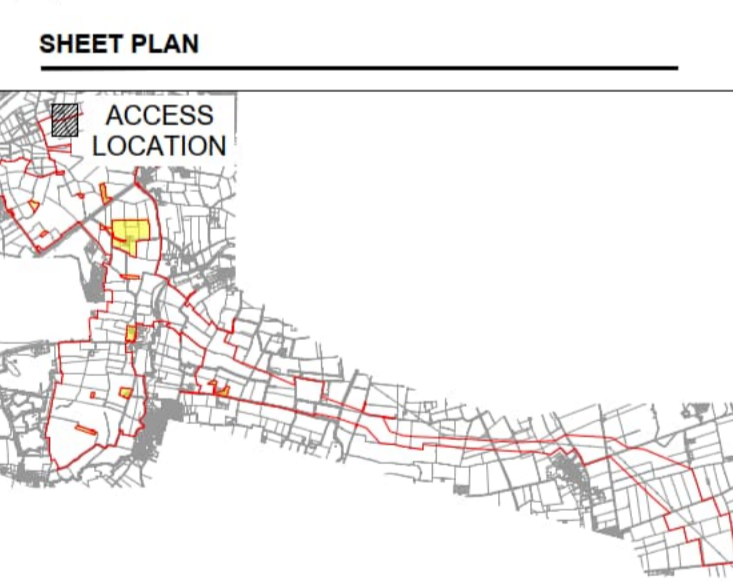

**ISSUE/REVISION**

NO	DATE	DESCRIPTION
P01	17/07/2025	DCO SUBMISSION

**LEGISLATION**  
 Regulation 5(2)(k) Infrastructure Planning (Applications: Prescribed Forms and Procedure) Regulations 2009

**ISSUE PURPOSE**  
 DCO SUBMISSION

FIGURE NUMBER	REV.
ACCESS O-001	01

**DOCUMENT REFERENCE**  
 EN10154/APP/7.18

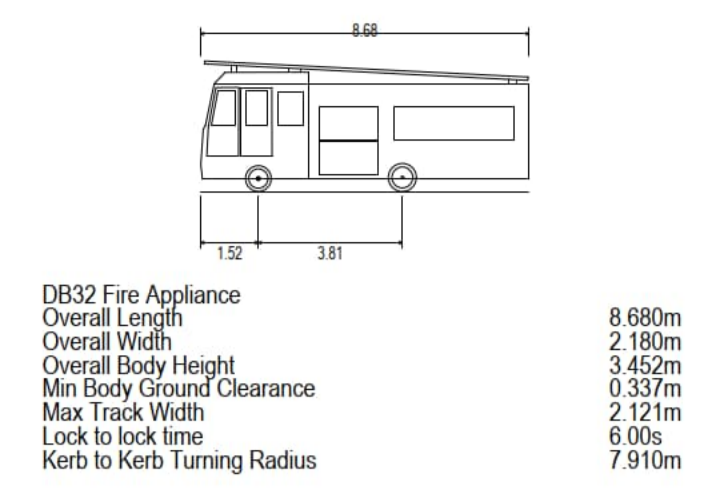

INSET A: DB32 FIRE APPLIANCE TURN LEFT OUT OF ACCESS ONTO CLAY LANE HEADING WEST - SCALE 1:500

INSET B: DB32 FIRE APPLIANCE TURNING RIGHT ONTO CLAY LANE HEADING EAST - SCALE 1:500

INSET C: DB32 FIRE APPLIANCE HEADING EAST ON CLAY LANE RIGHT TURN INTO ACCESS - SCALE 1:500

INSET D: DB32 FIRE APPLIANCE HEADING WEST ON CLAY LANE LEFT TURN INTO ACCESS - SCALE 1:500

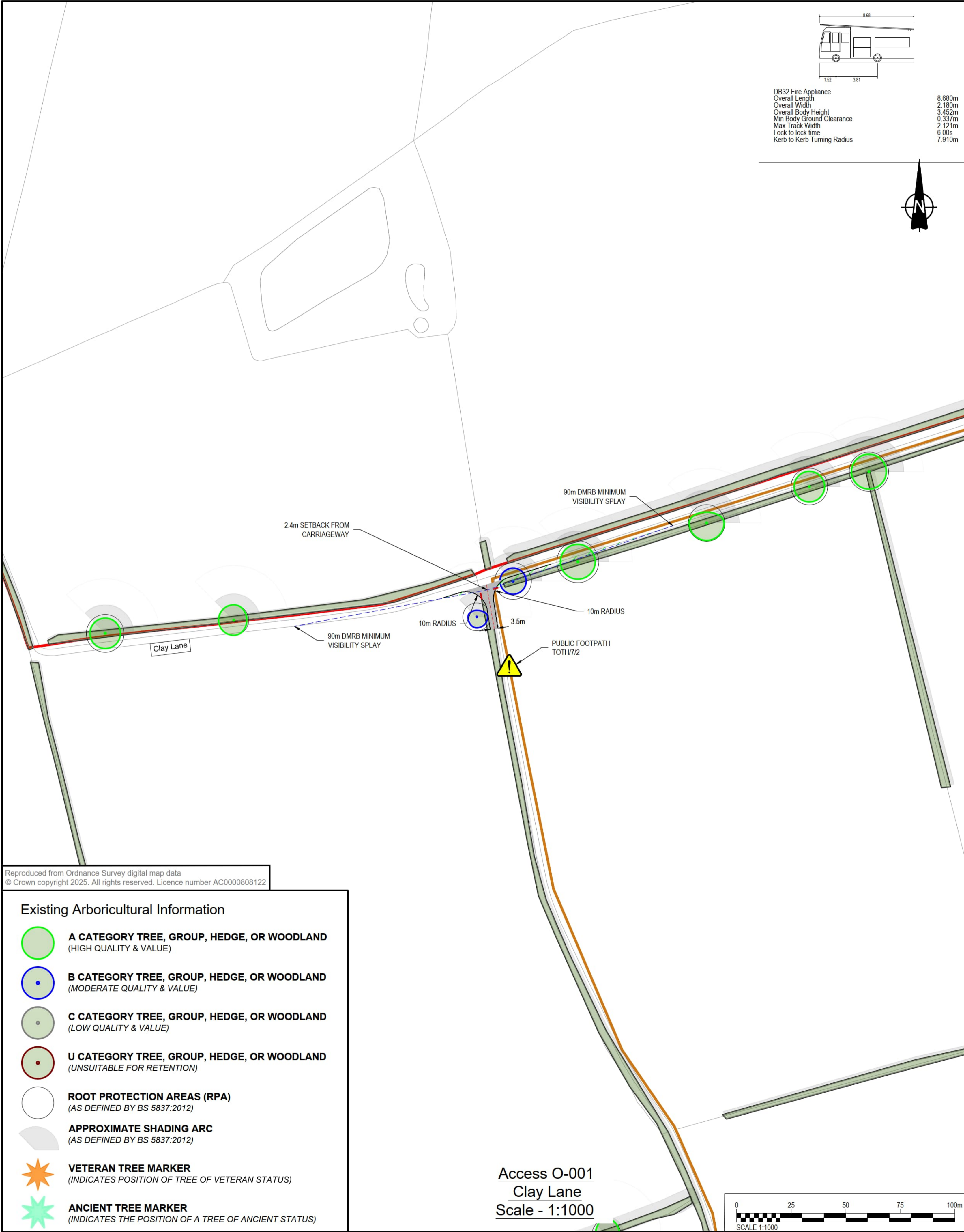

Reproduced from Ordnance Survey digital map data  
 © Crown copyright 2025. All rights reserved. Licence number AC0000808122

**Existing Arboricultural Information**

- A CATEGORY TREE, GROUP, HEDGE, OR WOODLAND** (HIGH QUALITY & VALUE)
- B CATEGORY TREE, GROUP, HEDGE, OR WOODLAND** (MODERATE QUALITY & VALUE)
- C CATEGORY TREE, GROUP, HEDGE, OR WOODLAND** (LOW QUALITY & VALUE)
- U CATEGORY TREE, GROUP, HEDGE, OR WOODLAND** (UNSUITABLE FOR RETENTION)
- ROOT PROTECTION AREAS (RPA)** (AS DEFINED BY BS 5837:2012)
- APPROXIMATE SHADING ARC** (AS DEFINED BY BS 5837:2012)
- VETERAN TREE MARKER** (INDICATES POSITION OF TREE OF VETERAN STATUS)
- ANCIENT TREE MARKER** (INDICATES THE POSITION OF A TREE OF ANCIENT STATUS)

**Access O-001**  
 Clay Lane  
 Scale - 1:1000

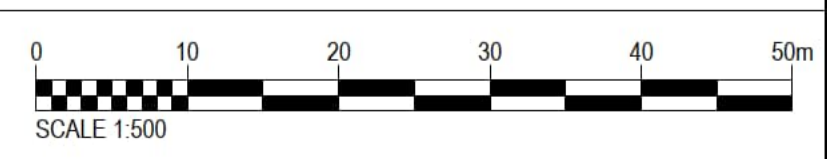
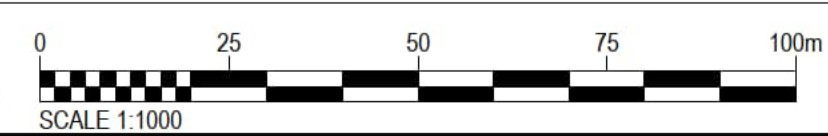

This drawing has been prepared for the use of AECOM's client. It may not be used, modified, reproduced or relied upon by third parties, except as agreed by AECOM or as required by law. AECOM accepts no responsibility, and denies any liability whatsoever, to any party that uses or relies on this drawing without AECOM's express written consent. Do not scale this document.



**PROJECT**  
 Fosse Green Energy

**CLIENT**  
 Fosse Green Energy Ltd

**CONSULTANT**  
 AECOM

- NOTES**
- This drawing is to be read in conjunction with all other relevant documentation.
  - Do not scale from this drawing, use only printed dimensions.
  - All dimensions in meters, all chainages, levels and coordinates are in meters unless defined otherwise.
  - This drawing is to be read in conjunction with the project Health & Safety File for any identified potential risks.
  - Vegetation to be removed denotes any vegetation features (such as hedgerows) that need to be removed to provide the required junction visibility. Any verge grassland is not to be removed but managed by the relevant maintainer to a low height so as to not impact upon junction visibility.
  - Vehicle tracking shown is indicative only, and represents approximate vehicle size & arrangement for the design vehicle shown.
  - These plans should also be read in conjunction with ES Volume 6.2 Appendix 10-H Arboricultural Impact Assessment, for details on hedgerow removal and tree protection.
  - Junction Visibility for the access is based upon visibility parameters derived using 85th Percentile Speed Survey Data received on 1st December 2023.

- LEGEND**
- Extent of Access Footprint
  - DCO Site Boundary
  - Existing Public Rights of Way
  - Vehicle body
  - Vehicle body path
  - Vehicle load
  - Vehicle load path
  - Vehicle wheels path
  - Edge of road
  - Land not included in the DCO Site Boundary
  - Junction Visibility Absolute Min.
  - Vegetation to be removed Absolute Min. Vis Splay
  - Junction Visibility DMRB Min.
  - Vegetation to be removed DMRB Min. Vis Splay
  - Indicative Hedgerow Removal Absolute Min. Vis Splay
  - Indicative Hedgerow Removal for Bellmouth Access
  - Approximate Structure Footprint
  - Health and Safety Risk Identifier

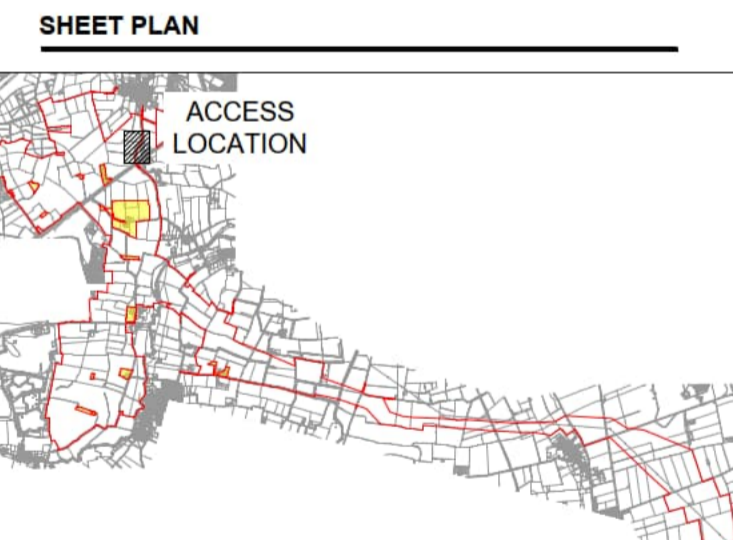

**ISSUE/REVISION**

NO.	DATE	DESCRIPTION
P01	17/07/2025	DCO SUBMISSION

**LEGISLATION**  
 Regulation 5(2)(k) Infrastructure Planning (Applications: Prescribed Forms and Procedure) Regulations 2009

**ISSUE PURPOSE**  
 DCO SUBMISSION

FIGURE NUMBER	REV.
ACCESS O-002	01

**DOCUMENT REFERENCE**  
 EN10154/APP/7.18

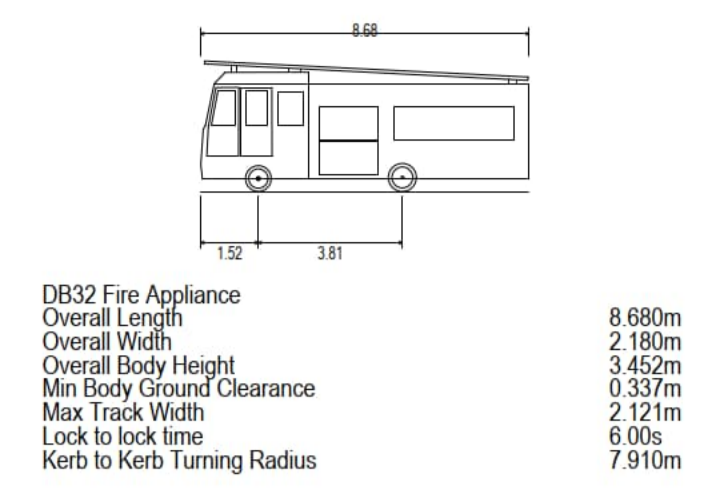

INSET A: DB32 FIRE APPLIANCE TURN LEFT OUT OF ACCESS ONTO FOSSE LANE HEADING NORTH - SCALE 1:500

INSET B: DB32 FIRE APPLIANCE TURNING RIGHT ONTO HADDINGTON LANE HEADING SOUTH - SCALE 1:500

INSET C: DB32 FIRE APPLIANCE HEADING NORTH ON HADDINGTON LANE LEFT TURN INTO ACCESS - SCALE 1:500

INSET D: DB32 FIRE APPLIANCE HEADING SOUTH ON FOSSE LANE RIGHT TURN INTO ACCESS - SCALE 1:500

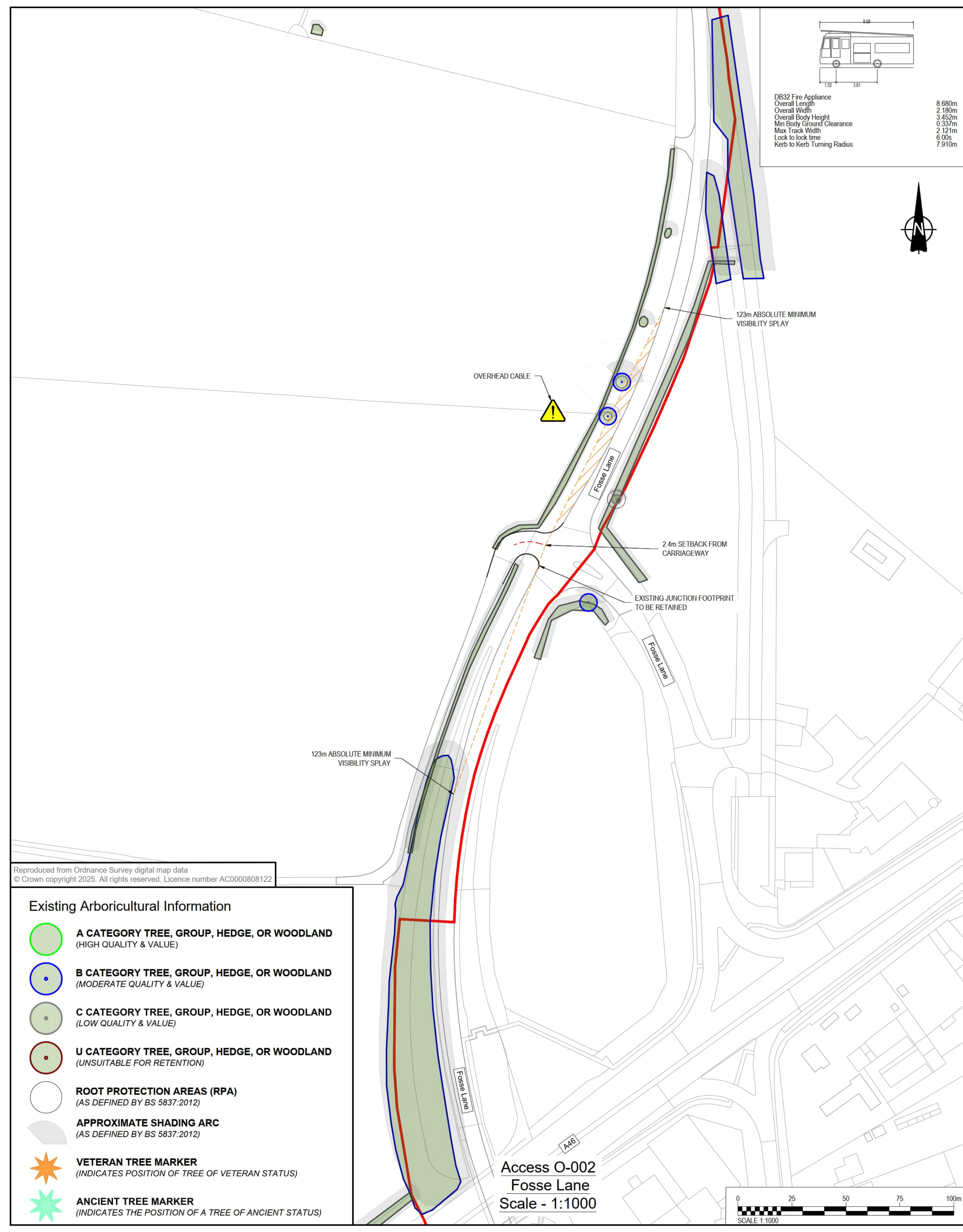

**Existing Arboricultural Information**

- A CATEGORY TREE, GROUP, HEDGE, OR WOODLAND** (HIGH QUALITY & VALUE)
- B CATEGORY TREE, GROUP, HEDGE, OR WOODLAND** (MODERATE QUALITY & VALUE)
- C CATEGORY TREE, GROUP, HEDGE, OR WOODLAND** (LOW QUALITY & VALUE)
- U CATEGORY TREE, GROUP, HEDGE, OR WOODLAND** (UNSUITABLE FOR RETENTION)
- ROOT PROTECTION AREAS (RPA)** (AS DEFINED BY BS 5837:2012)
- APPROXIMATE SHADING ARC** (AS DEFINED BY BS 5837:2012)
- VETERAN TREE MARKER** (INDICATES POSITION OF TREE OF VETERAN STATUS)
- ANCIENT TREE MARKER** (INDICATES THE POSITION OF A TREE OF ANCIENT STATUS)

**Access O-002**  
 Fosse Lane  
 Scale - 1:1000

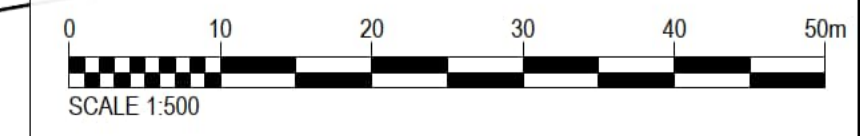
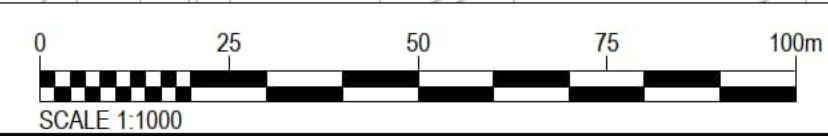

Reproduced from Ordnance Survey digital map data  
 © Crown copyright 2025. All rights reserved. Licence number AC0000808122

This drawing has been prepared for the use of AECOM's client. It may not be used, modified, reproduced or relied upon by third parties, except as agreed by AECOM or as required by law. AECOM accepts no responsibility, and denies any liability whatsoever, to any party that uses or relies on this drawing without AECOM's express written consent. Do not scale this document.

- NOTES**
- This drawing is to be read in conjunction with all other relevant documentation.
  - Do not scale from this drawing, use only printed dimensions.
  - All dimensions in meters, all chainages, levels and coordinates are in meters unless defined otherwise.
  - This drawing is to be read in conjunction with the project Health & Safety File for any identified potential risks.
  - Vegetation to be removed denotes any vegetation features (such as hedgerows) that need to be removed to provide the required junction visibility. Any verge grassland is not to be removed but managed by the relevant maintainer to a low height so as to not impact upon junction visibility.
  - Vehicle tracking shown is indicative only, and represents approximate vehicle size & arrangement for the design vehicle shown.
  - These plans should also be read in conjunction with ES Volume 6.2 Appendix 10-H Arboricultural Impact Assessment, for details on hedgerow removal and tree protection.
  - Junction Visibility for the access is based upon visibility parameters derived using 85th Percentile Speed Survey Data received on 1st December 2023.

- LEGEND**
- Extent of Access Footprint
  - DCO Site Boundary
  - Existing Public Rights of Way
  - Vehicle body
  - Vehicle body path
  - Vehicle load
  - Vehicle load path
  - Vehicle wheels path
  - Edge of road
  - Land not included in the DCO Site Boundary
  - Junction Visibility Absolute Min.
  - Vegetation to be removed Absolute Min. Vis Splay
  - Junction Visibility DMRB Min.
  - Vegetation to be removed DMRB Min. Vis Splay
  - Indicative Hedgerow Removal Absolute Min. Vis Splay
  - Indicative Hedgerow Removal for Bellmouth Access
  - Approximate Structure Footprint
  - Health and Safety Risk Identifier

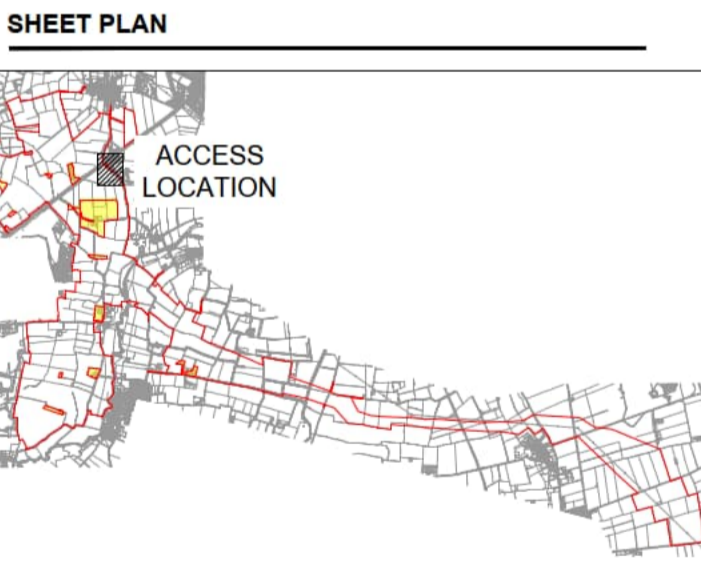

**ISSUE/REVISION**

NO.	DATE	DESCRIPTION
P01	17/07/2025	DCO SUBMISSION
I/R	DATE	DESCRIPTION

**LEGISLATION**  
 Regulation 5(2)(k) Infrastructure Planning (Applications: Prescribed Forms and Procedure) Regulations 2009

**ISSUE PURPOSE**  
 DCO SUBMISSION

FIGURE NUMBER	REV.
ACCESS O-003	01

**DOCUMENT REFERENCE**  
 EN010154/APP/7.18

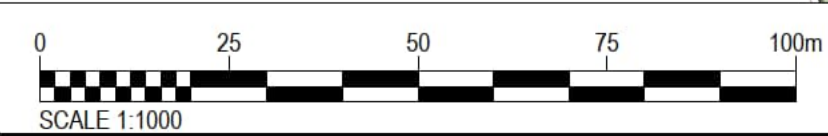
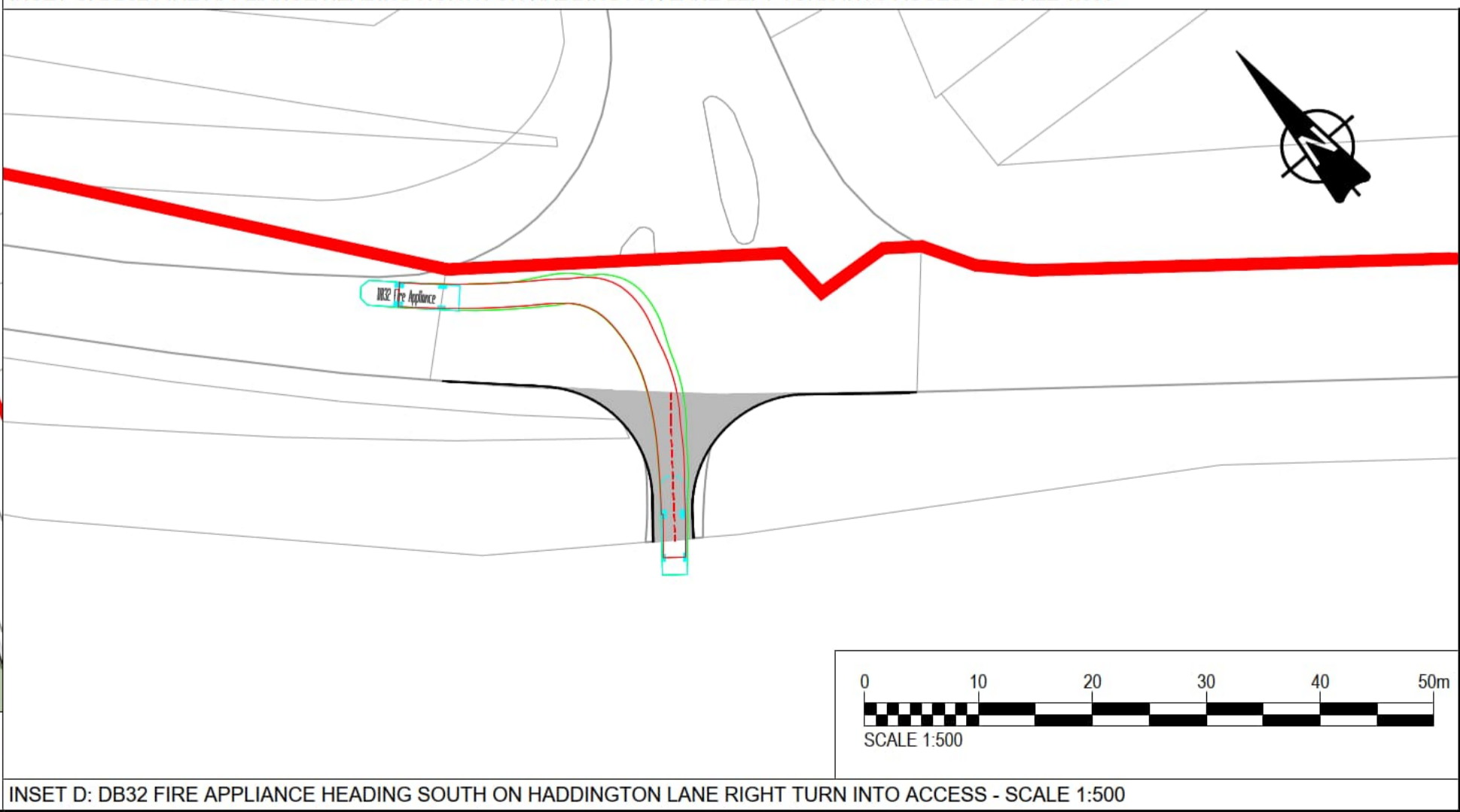
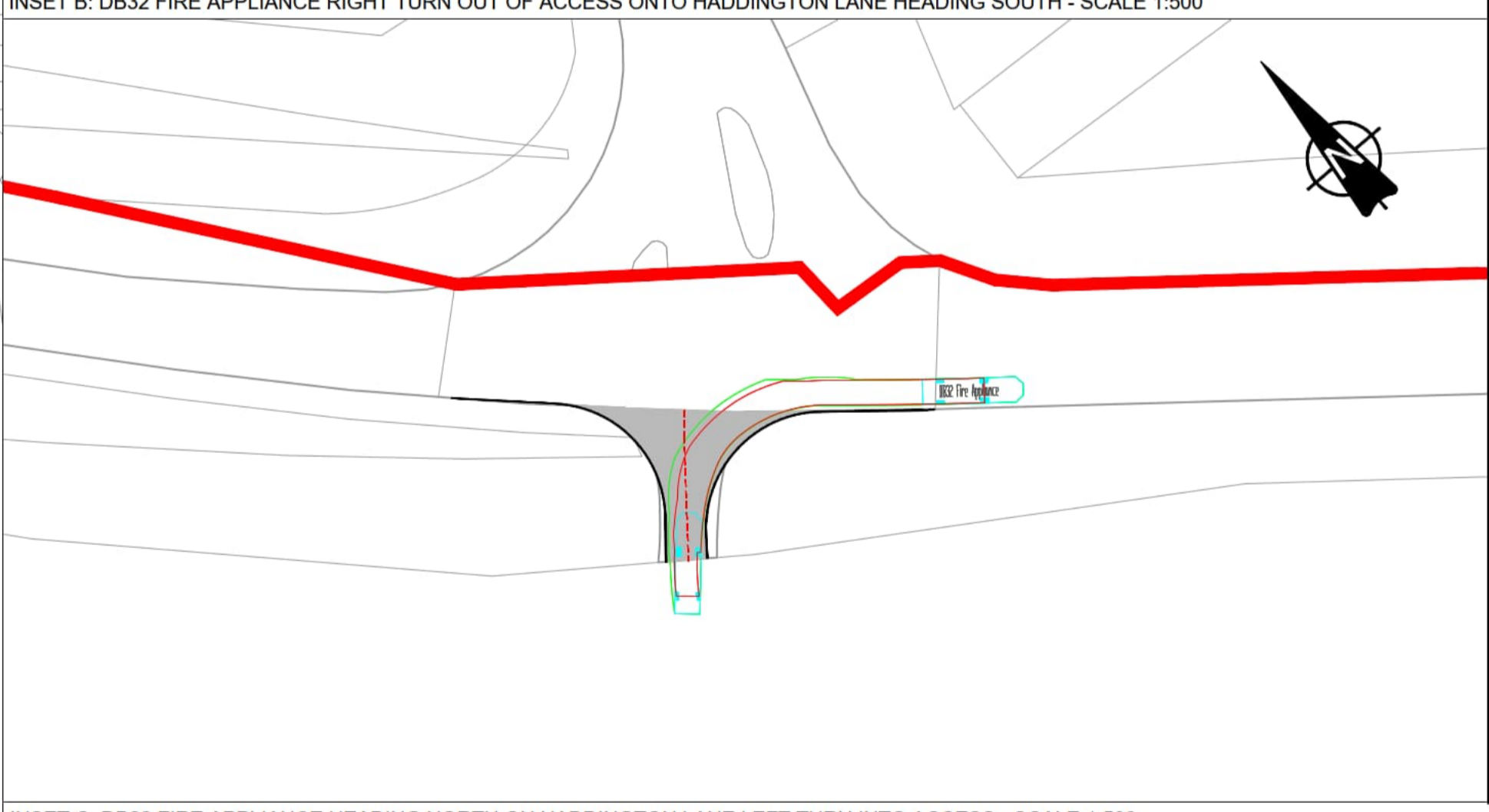
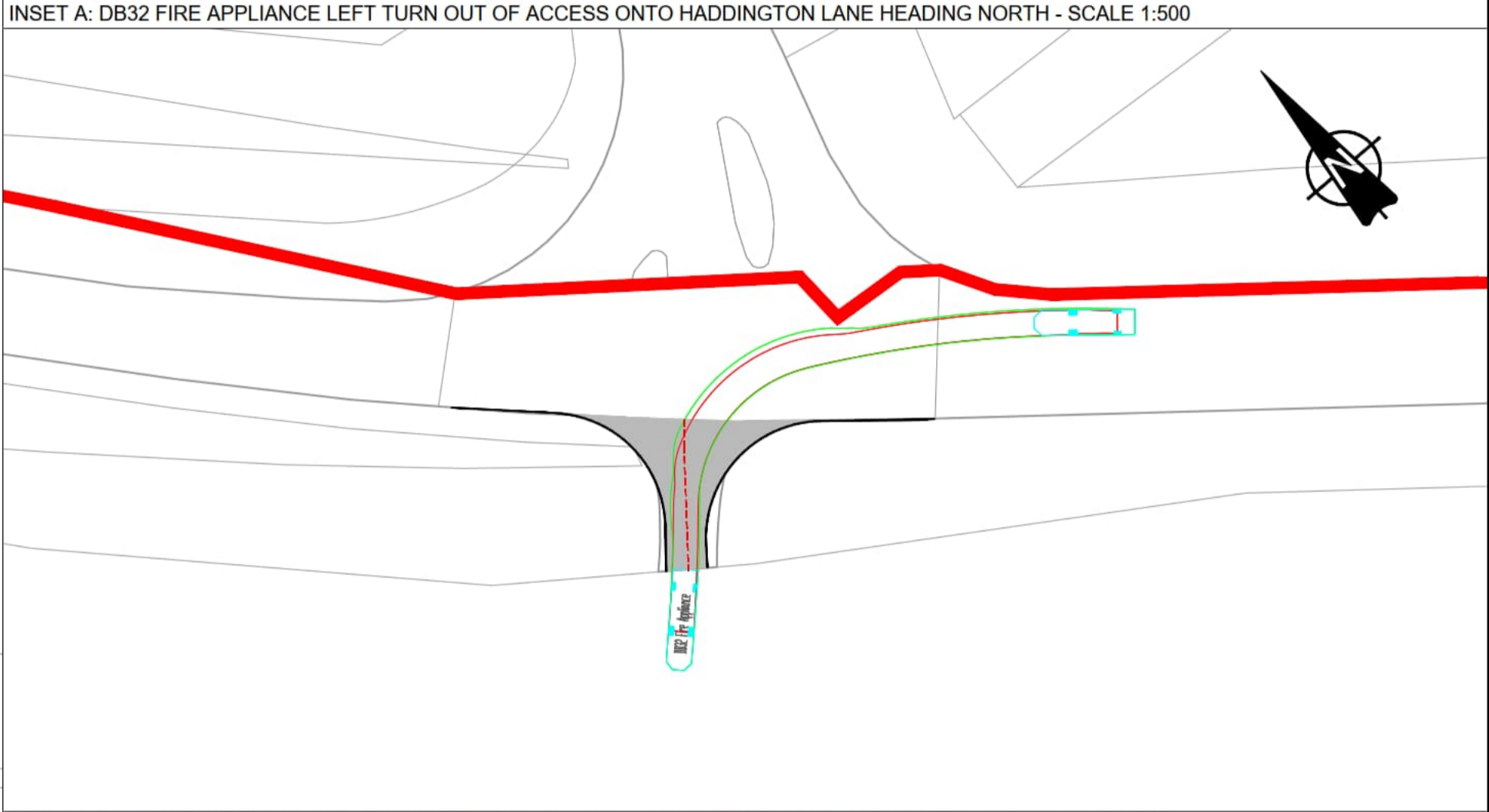
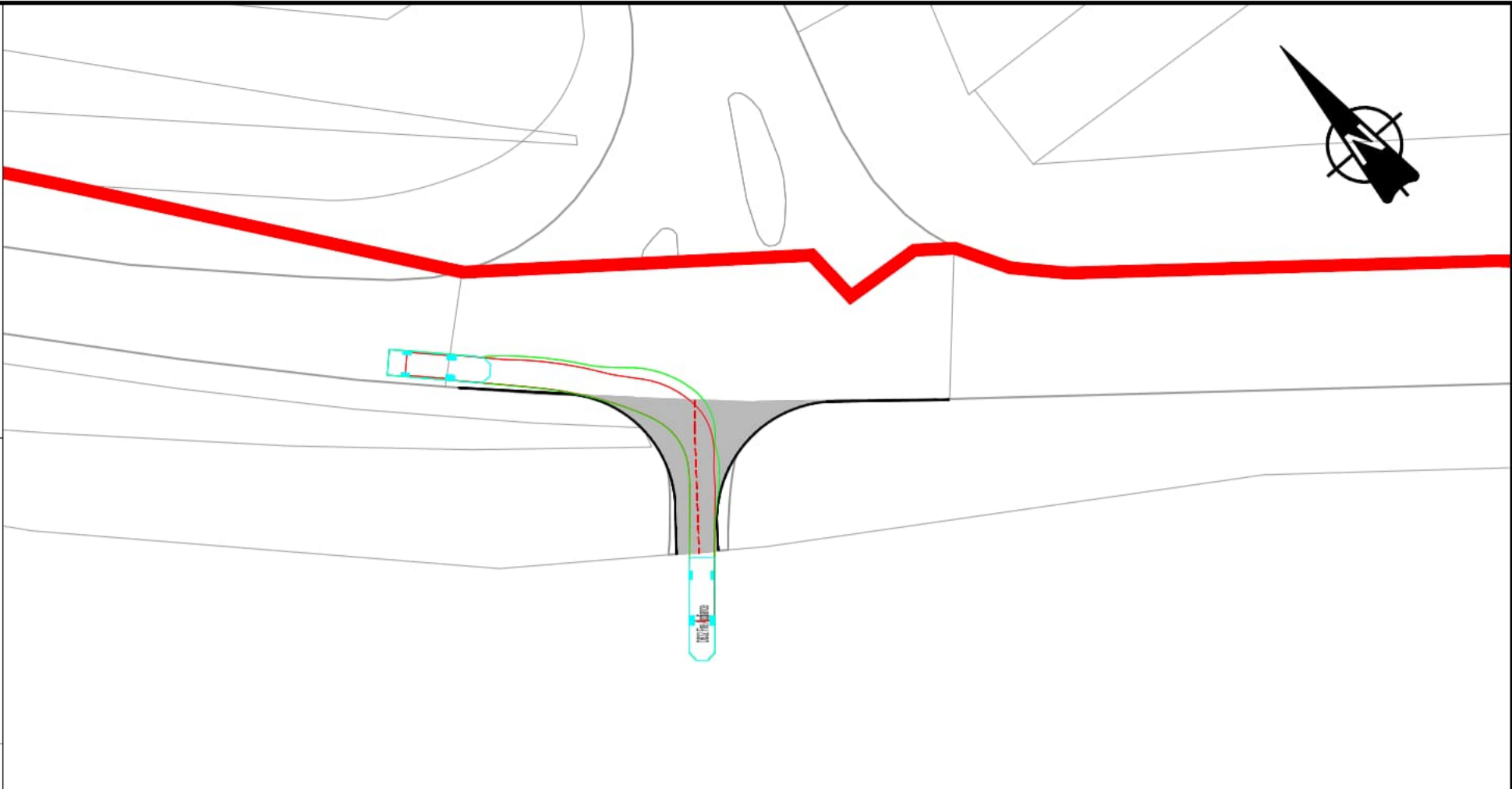
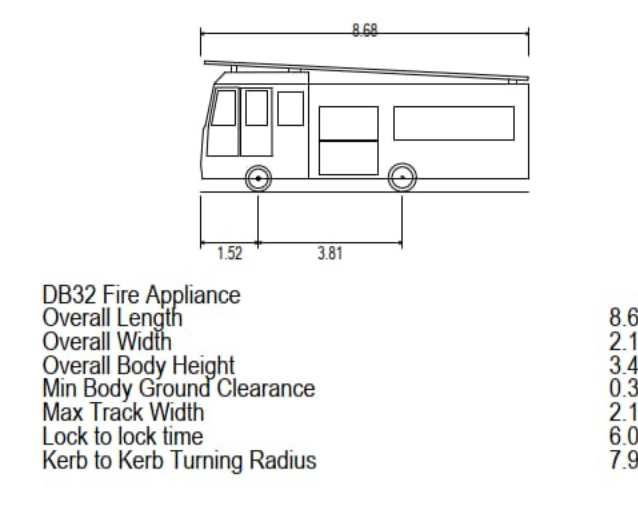
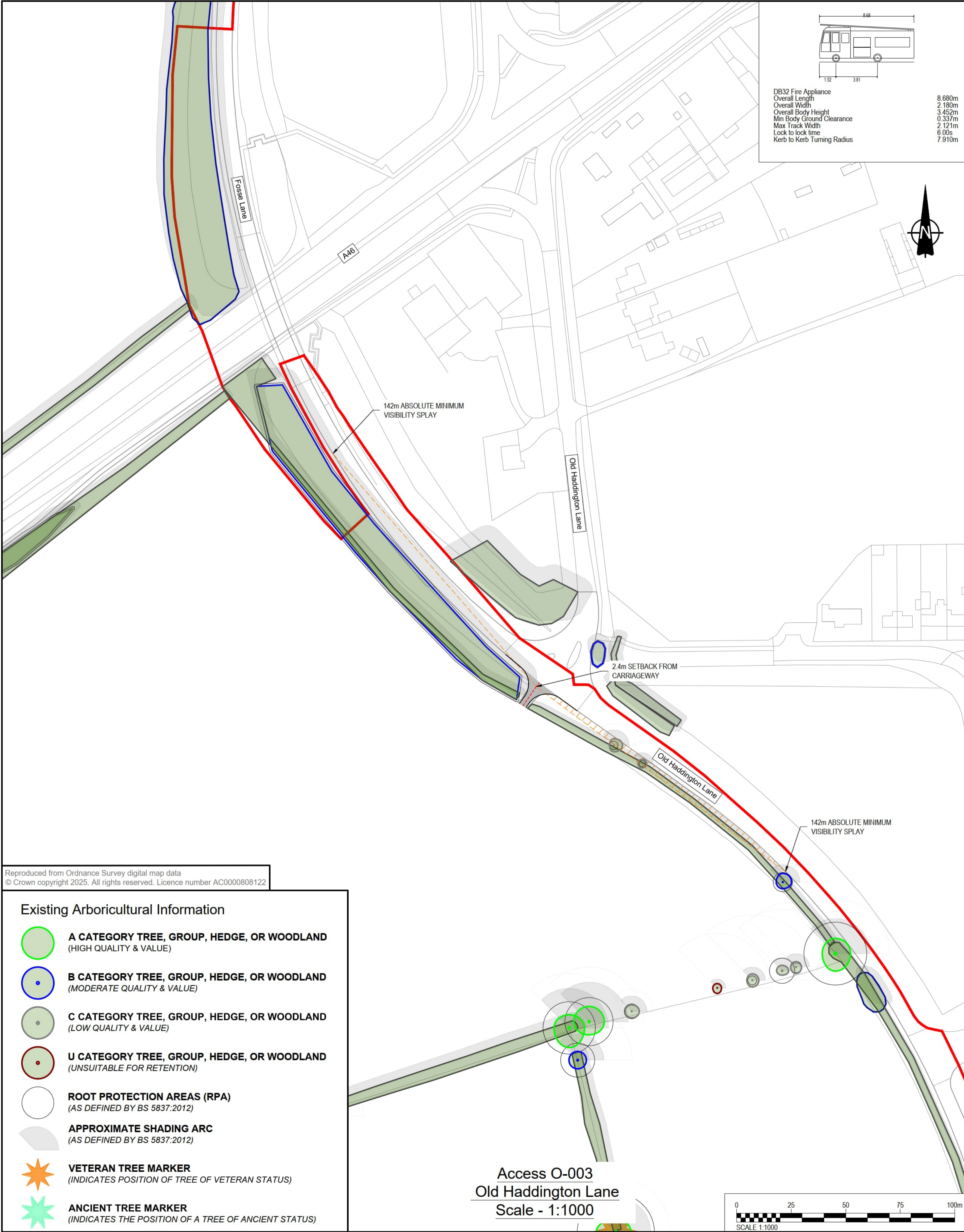

This drawing has been prepared for the use of AECOM's client. It may not be used, modified, reproduced or relied upon by third parties, except as agreed by AECOM or as required by law. AECOM accepts no responsibility, and denies any liability whatsoever, to any party that uses or relies on this drawing without AECOM's express written consent. Do not scale this document.

- NOTES**
- This drawing is to be read in conjunction with all other relevant documentation.
  - Do not scale from this drawing, use only printed dimensions.
  - All dimensions in meters, all chainages, levels and coordinates are in meters unless defined otherwise.
  - This drawing is to be read in conjunction with the project Health & Safety File for any identified potential risks.
  - Vegetation to be removed denotes any vegetation features (such as hedgerows) that need to be removed to provide the required junction visibility. Any verge grassland is not to be removed but managed by the relevant maintainer to a low height so as to not impact upon junction visibility.
  - Vehicle tracking shown is indicative only, and represents approximate vehicle size & arrangement for the design vehicle shown.
  - These plans should also be read in conjunction with ES Volume 6.2 Appendix 10-H Arboricultural Impact Assessment, for details on hedgerow removal and tree protection.
  - Junction Visibility for the access is based upon visibility parameters derived using 85th Percentile Speed Survey Data received On 1st December 2023.

- LEGEND**
- Extent of Access Footprint
  - DCO Site Boundary
  - Existing Public Rights of Way
  - Vehicle body
  - Vehicle body path
  - Vehicle load
  - Vehicle load path
  - Vehicle wheels path
  - Edge of road
  - Land not included in the DCO Site Boundary
  - Junction Visibility Absolute Min.
  - Vegetation to be removed Absolute Min. Vis Splay
  - Junction Visibility DMRB Min.
  - Vegetation to be removed DMRB Min. Vis Splay
  - Indicative Hedgerow Removal Absolute Min. Vis Splay
  - Indicative Hedgerow Removal for Bellmouth Access
  - Approximate Structure Footprint
  - Health and Safety Risk Identifier

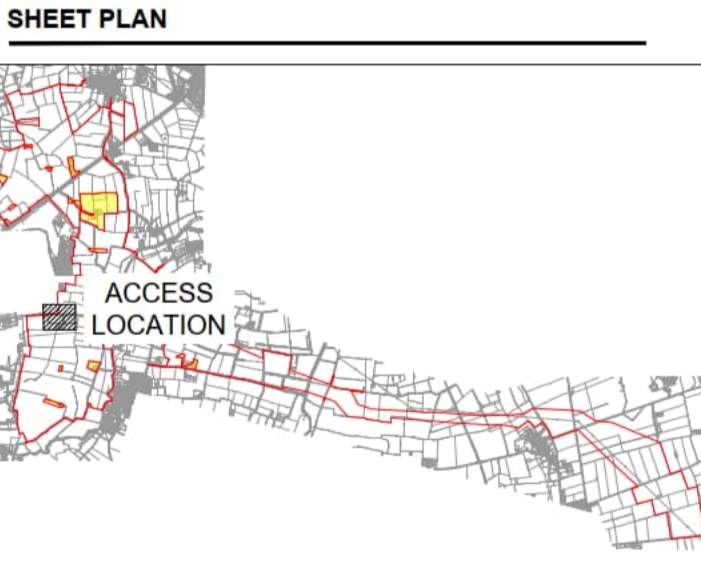

**ISSUE/REVISION**

NO.	DATE	DESCRIPTION
P01	17/07/2025	DCO SUBMISSION
I/R	DATE	DESCRIPTION

**LEGISLATION**  
 Regulation 5(2)(k) Infrastructure Planning (Applications: Prescribed Forms and Procedure) Regulations 2009

**ISSUE PURPOSE**  
 DCO SUBMISSION

FIGURE NUMBER	REV.
ACCESS O-004	01

**DOCUMENT REFERENCE**  
 EN10154/APP/7.18

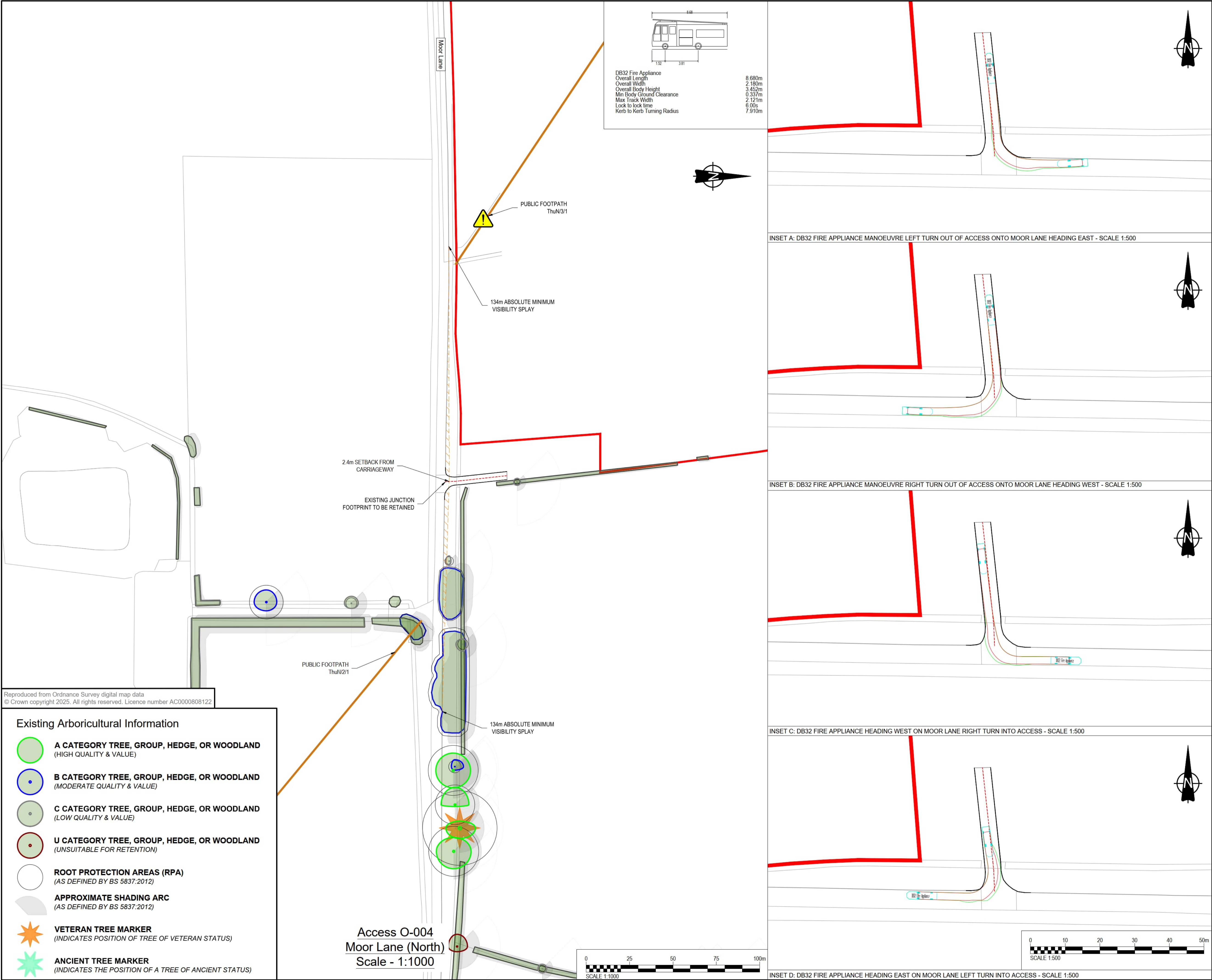

**Existing Arboricultural Information**

- A CATEGORY TREE, GROUP, HEDGE, OR WOODLAND (HIGH QUALITY & VALUE)**
- B CATEGORY TREE, GROUP, HEDGE, OR WOODLAND (MODERATE QUALITY & VALUE)**
- C CATEGORY TREE, GROUP, HEDGE, OR WOODLAND (LOW QUALITY & VALUE)**
- U CATEGORY TREE, GROUP, HEDGE, OR WOODLAND (UNSUITABLE FOR RETENTION)**
- ROOT PROTECTION AREAS (RPA) (AS DEFINED BY BS 5837:2012)**
- APPROXIMATE SHADING ARC (AS DEFINED BY BS 5837:2012)**
- VETERAN TREE MARKER (INDICATES POSITION OF TREE OF VETERAN STATUS)**
- ANCIENT TREE MARKER (INDICATES THE POSITION OF A TREE OF ANCIENT STATUS)**

Reproduced from Ordnance Survey digital map data © Crown copyright 2025. All rights reserved. Licence number AC0000808122

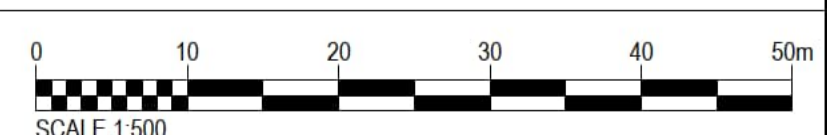
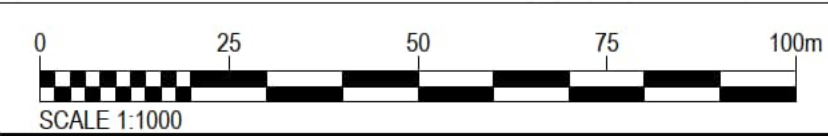

This drawing has been prepared for the use of AECOM's client. It may not be used, modified, reproduced or relied upon by third parties, except as agreed by AECOM or as required by law. AECOM accepts no responsibility, and denies any liability whatsoever, to any party that uses or relies on this drawing without AECOM's express written consent. Do not scale this document.

- NOTES**
- This drawing is to be read in conjunction with all other relevant documentation.
  - Do not scale from this drawing, use only printed dimensions.
  - All dimensions in meters, all chainages, levels and coordinates are in meters unless defined otherwise.
  - This drawing is to be read in conjunction with the project Health & Safety File for any identified potential risks.
  - Vegetation to be removed denotes any vegetation features (such as hedgerows) that need to be removed to provide the required junction visibility. Any verge grassland is not to be removed but managed by the relevant maintainer to a low height so as to not impact upon junction visibility.
  - Vehicle tracking shown is indicative only, and represents approximate vehicle size & arrangement for the design vehicle shown.
  - These plans should also be read in conjunction with ES Volume 6.2 Appendix 10-H Arboricultural Impact Assessment, for details on hedgerow removal and tree protection.
  - Junction Visibility for the access is based on DMRB CD109, Table 2.10.

- LEGEND**
- Extent of Access Footprint
  - DCO Site Boundary
  - Existing Public Rights of Way
  - Vehicle body
  - Vehicle body path
  - Vehicle load
  - Vehicle load path
  - Vehicle wheels path
  - Edge of road
  - Land not included in the DCO Site Boundary
  - Junction Visibility Absolute Min.
  - Vegetation to be removed Absolute Min. Vis Splay
  - Junction Visibility DMRB Min.
  - Vegetation to be removed DMRB Min. Vis Splay
  - Indicative Hedgerow Removal Absolute Min. Vis Splay
  - Indicative Hedgerow Removal for Bellmouth Access
  - Approximate Structure Footprint
  - Health and Safety Risk Identifier

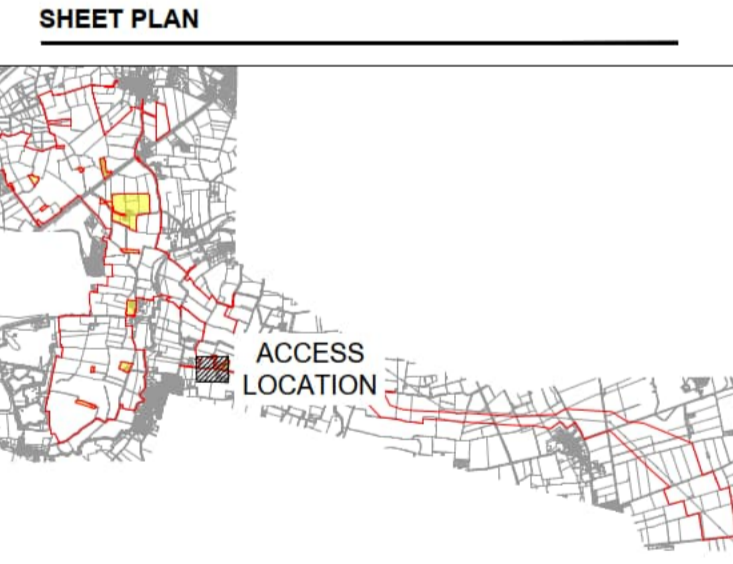

**ISSUE/REVISION**

NO	DATE	DESCRIPTION
P01	17/07/2025	DCO SUBMISSION

**LEGISLATION**  
Regulation 5(2)(k) Infrastructure Planning (Applications: Prescribed Forms and Procedure) Regulations 2009

**ISSUE PURPOSE**  
DCO SUBMISSION

FIGURE NUMBER	REV.
ACCESS O-005	01

**DOCUMENT REFERENCE**  
EN10154/APP/7.18

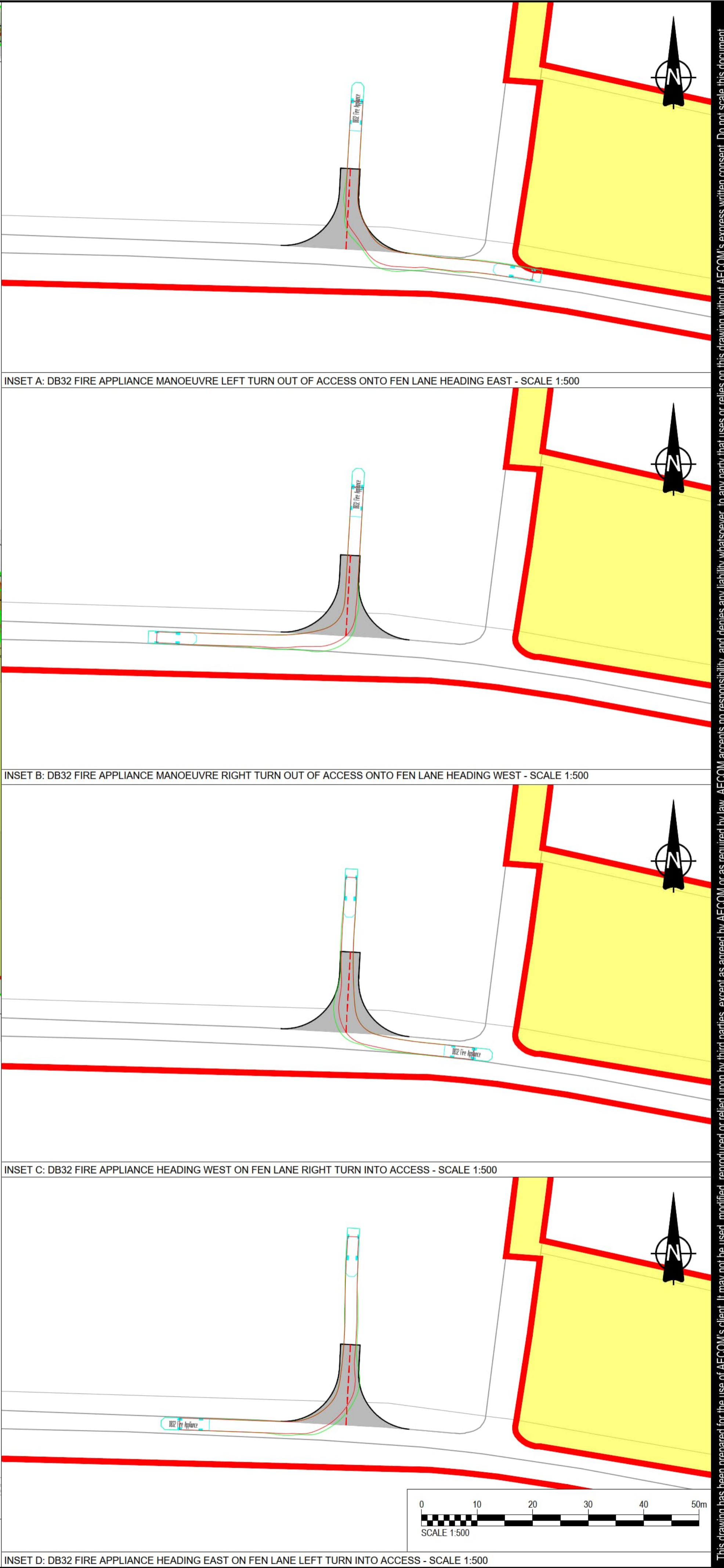
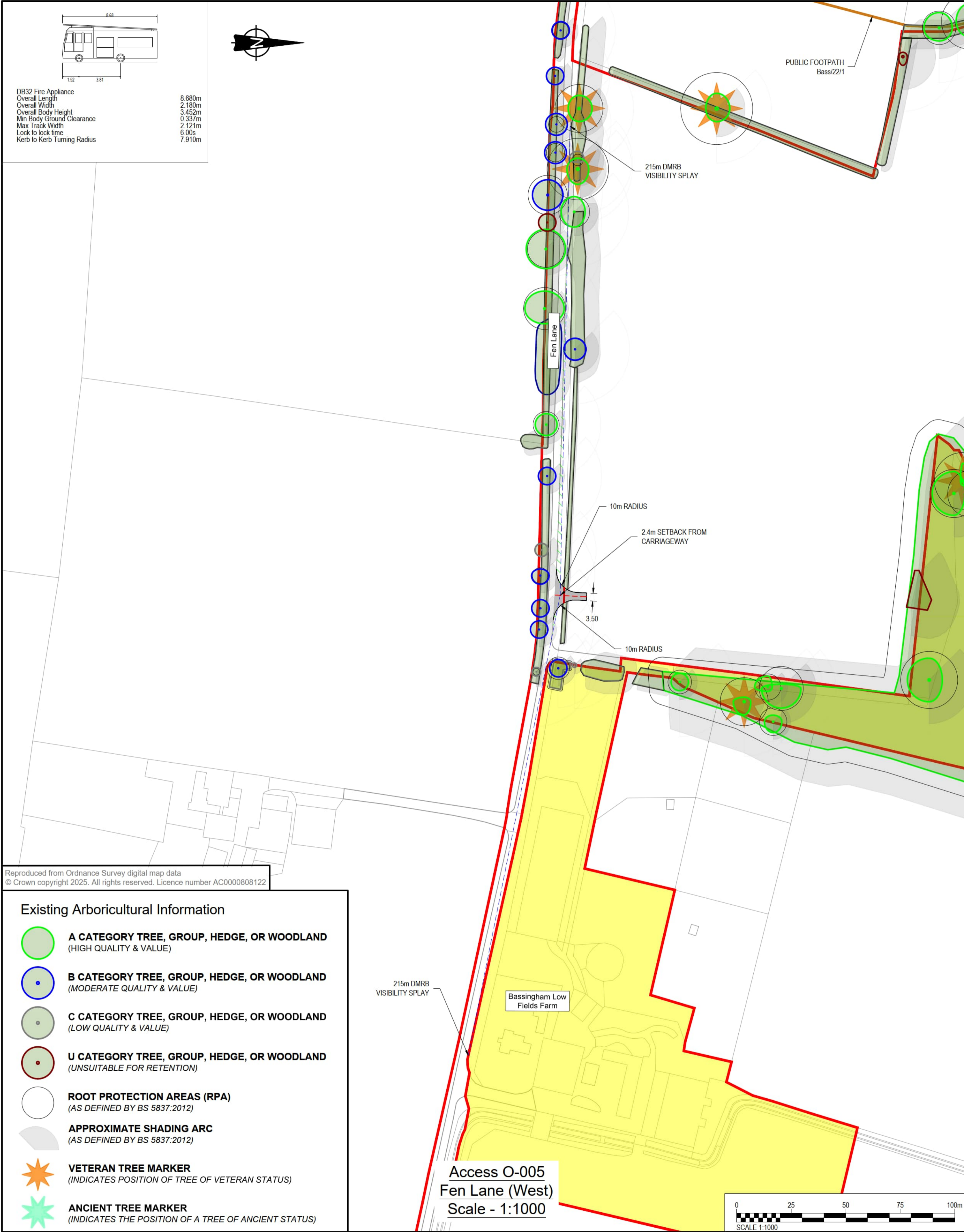

This drawing has been prepared for the use of AECOM's client. It may not be used, modified, reproduced or relied upon by third parties, except as agreed by AECOM, and AECOM accepts no responsibility, and denies any liability whatsoever, to any party that uses or relies on this drawing without AECOM's express written consent. Do not scale this document.

- NOTES**
- This drawing is to be read in conjunction with all other relevant documentation.
  - Do not scale from this drawing, use only printed dimensions.
  - All dimensions in meters, all chainages, levels and coordinates are in meters unless defined otherwise.
  - This drawing is to be read in conjunction with the project Health & Safety File for any identified potential risks.
  - Vegetation to be removed denotes any vegetation features (such as hedgerows) that need to be removed to provide the required junction visibility. Any verge grassland is not to be removed but managed by the relevant maintainer to a low height so as to not impact upon junction visibility.
  - Vehicle tracking shown is indicative only, and represents approximate vehicle size & arrangement for the design vehicle shown.
  - These plans should also be read in conjunction with ES Volume 6.2 Appendix 10-H Arboricultural Impact Assessment, for details on hedgerow removal and tree protection.
  - Junction Visibility for the access is based on DMRB CD109, Table 2.10.

- LEGEND**
- Extent of Access Footprint
  - DCO Site Boundary
  - Existing Public Rights of Way
  - Vehicle body
  - Vehicle body path
  - Vehicle load
  - Vehicle load path
  - Vehicle wheels path
  - Edge of road
  - Land not included in the DCO Site Boundary
  - Junction Visibility Absolute Min.
  - Vegetation to be removed Absolute Min. Vis Splay
  - Junction Visibility DMRB Min.
  - Vegetation to be removed DMRB Min. Vis Splay
  - Indicative Hedgerow Removal Absolute Min. Vis Splay
  - Indicative Hedgerow Removal for Bellmouth Access
  - Approximate Structure Footprint
  - Health and Safety Risk Identifier

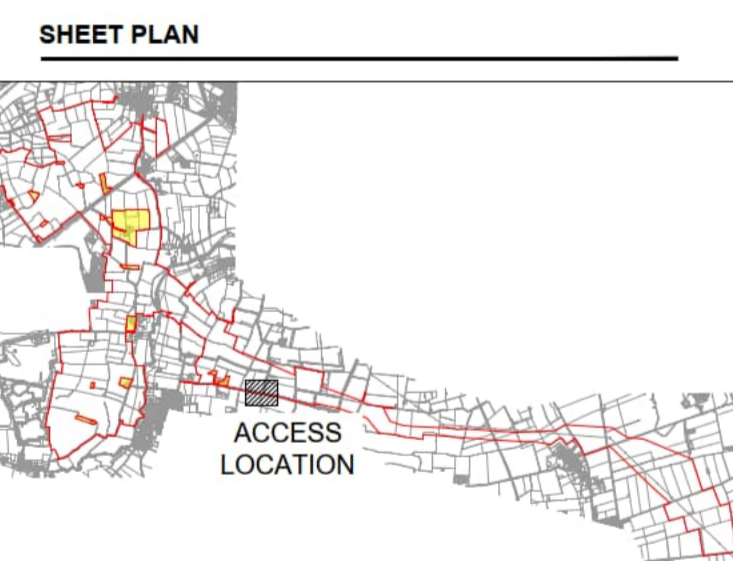

**ISSUE/REVISION**

NO	DATE	DESCRIPTION
P01	17/07/2025	DCO SUBMISSION

**LEGISLATION**  
 Regulation 5(2)(k) Infrastructure Planning (Applications: Prescribed Forms and Procedure) Regulations 2009

**ISSUE PURPOSE**  
 DCO SUBMISSION

FIGURE NUMBER	REV.
ACCESS O-006	01

**DOCUMENT REFERENCE**  
 EN10154/APP/7.18

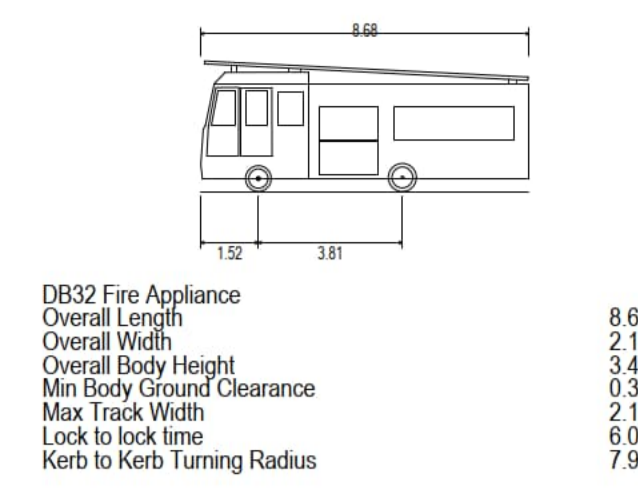

INSET A: DB32 FIRE APPLIANCE MANOEUVRE LEFT TURN OUT OF ACCESS ONTO FEN LANE HEADING EAST - SCALE 1:500

INSET B: DB32 FIRE APPLIANCE MANOEUVRE RIGHT TURN OUT OF ACCESS ONTO FEN LANE HEADING WEST - SCALE 1:500

INSET C: DB32 FIRE APPLIANCE HEADING EAST ON FEN LANE LEFT TURN INTO ACCESS - SCALE 1:500

INSET D: DB32 FIRE APPLIANCE HEADING WEST ON FEN LANE RIGHT TURN INTO ACCESS - SCALE 1:500

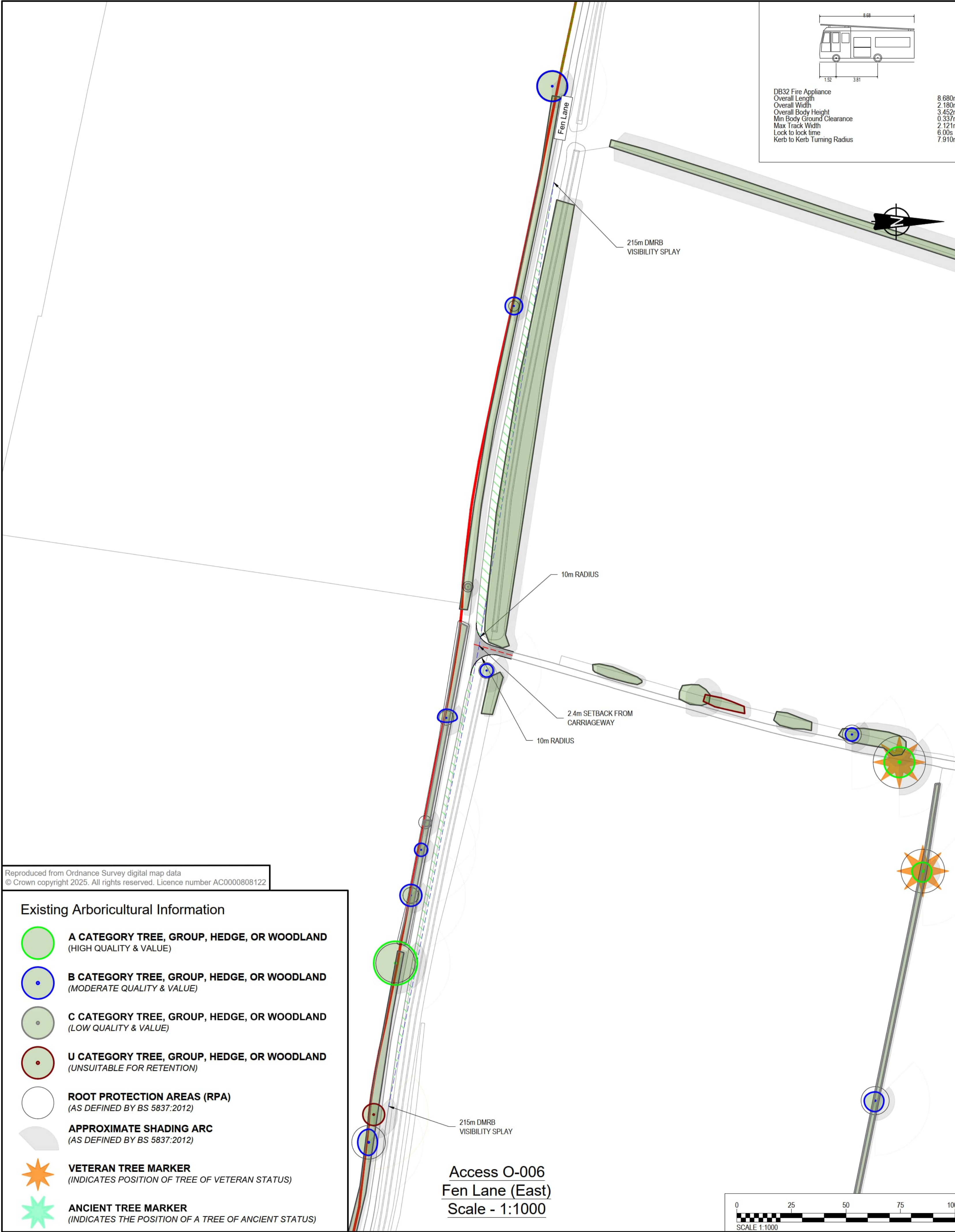

- Existing Arboricultural Information**
- A CATEGORY TREE, GROUP, HEDGE, OR WOODLAND** (HIGH QUALITY & VALUE)
  - B CATEGORY TREE, GROUP, HEDGE, OR WOODLAND** (MODERATE QUALITY & VALUE)
  - C CATEGORY TREE, GROUP, HEDGE, OR WOODLAND** (LOW QUALITY & VALUE)
  - U CATEGORY TREE, GROUP, HEDGE, OR WOODLAND** (UNSUITABLE FOR RETENTION)
  - ROOT PROTECTION AREAS (RPA)** (AS DEFINED BY BS 5837:2012)
  - APPROXIMATE SHADING ARC** (AS DEFINED BY BS 5837:2012)
  - VETERAN TREE MARKER** (INDICATES POSITION OF TREE OF VETERAN STATUS)
  - ANCIENT TREE MARKER** (INDICATES THE POSITION OF A TREE OF ANCIENT STATUS)

Reproduced from Ordnance Survey digital map data  
 © Crown copyright 2025. All rights reserved. Licence number AC0000808122

This drawing has been prepared for the use of AECOM's client. It may not be used, modified, reproduced or relied upon by third parties, except as agreed by AECOM or as required by law. AECOM accepts no responsibility, and denies any liability whatsoever, to any party that uses or relies on this drawing without AECOM's express written consent. Do not scale this document.

ISO A1 594mm x 841mm  
 Project No.: 60700987  
 Drawn: GT  
 Checked: MEK  
 Approved: JH  
 Date: 17/07/2025  
 Last saved by: TAYLOR/5/2025/07/07  
 Last Plot: 2025/07/17  
 Filename: C:\USERS\TAYLOR\AECOM\FOSSE GREEN ENERGY PROJECT (AECOM) - GENERAL\900\_CAD\_GIS\913\_HIGHWAYS\DRAWINGS (CAD)\ACCESS DRAWINGS DCO\60700987-ACM-HGN-DR-CH-0027.DWG

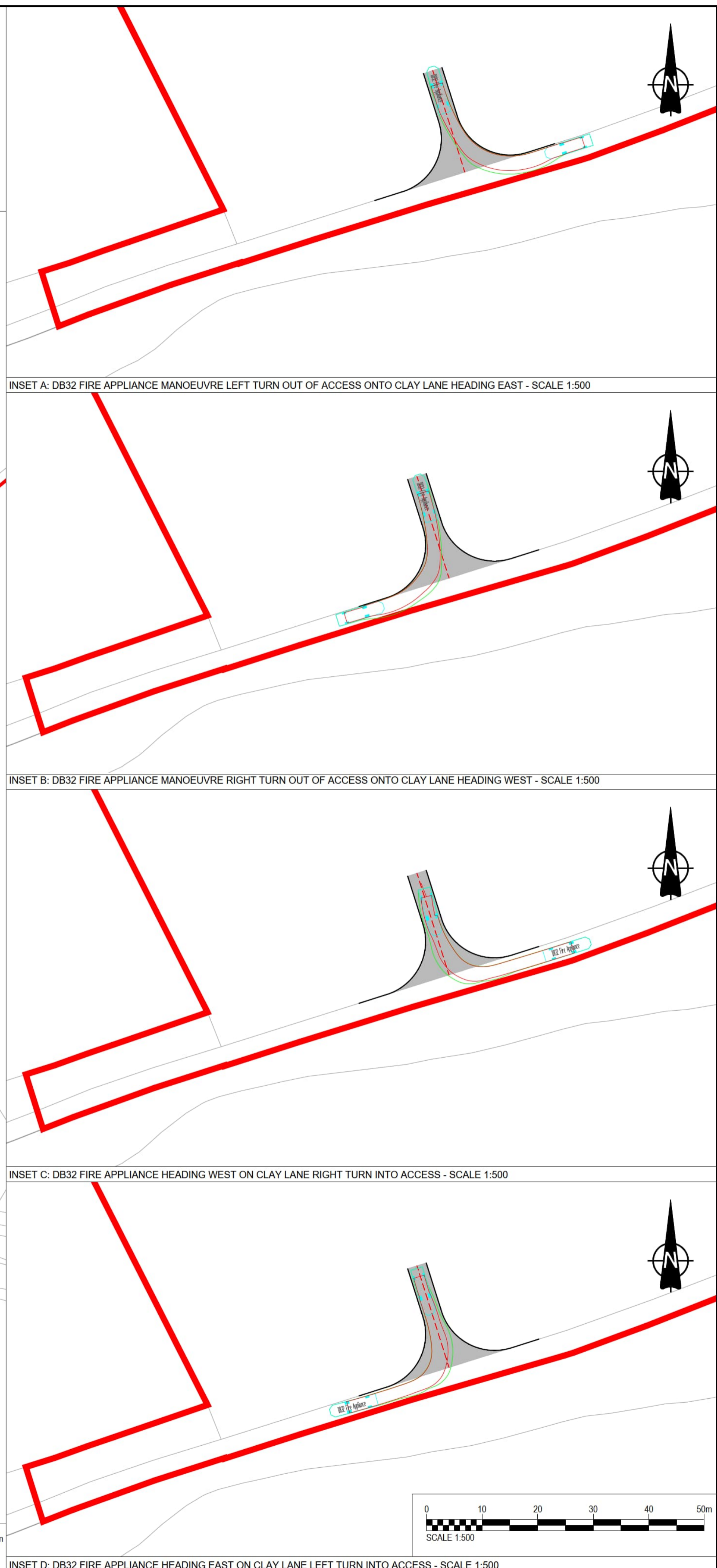
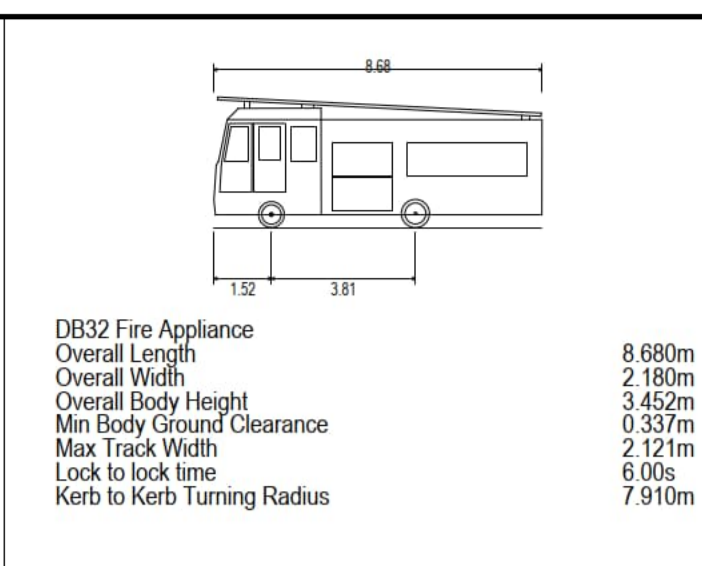
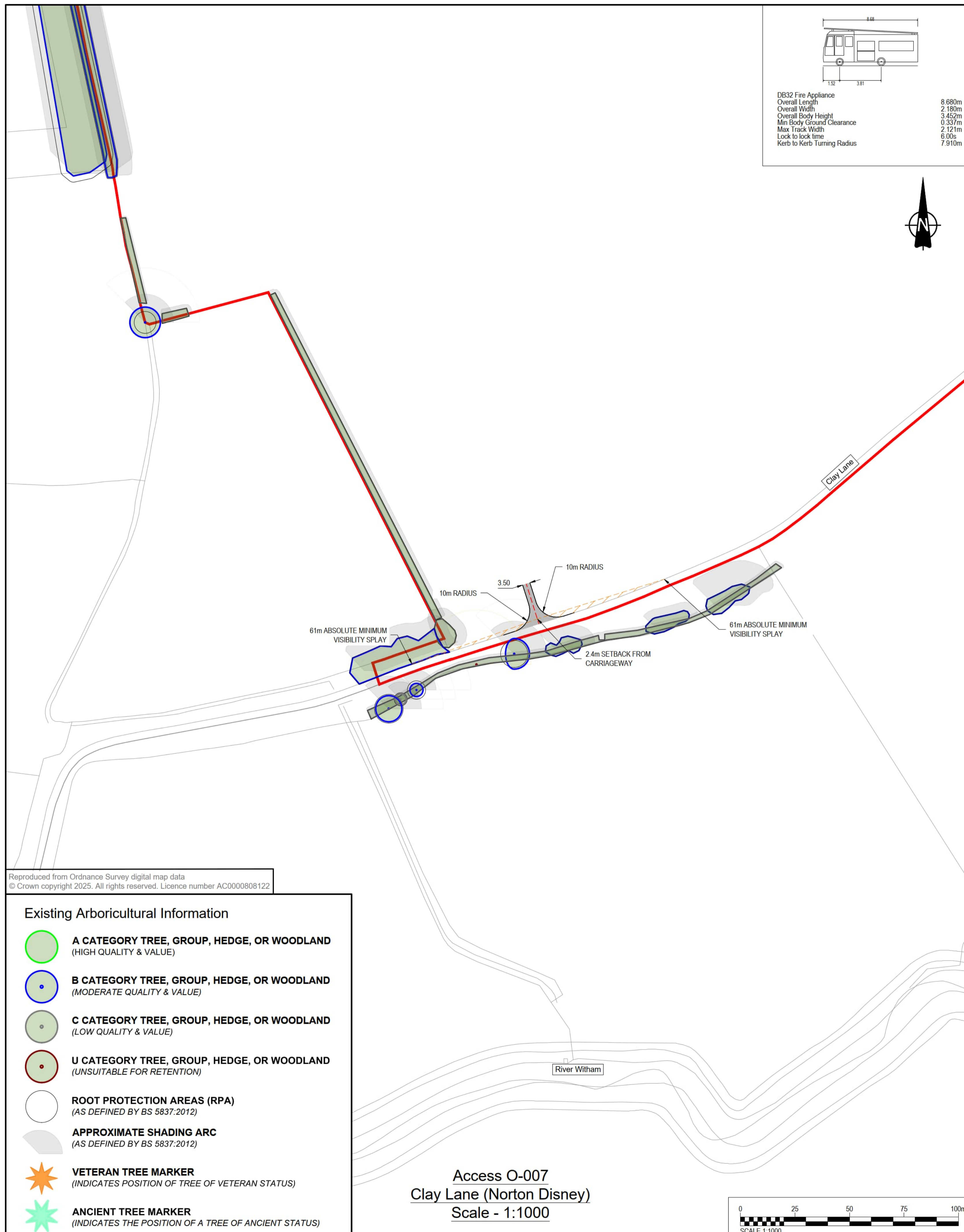

Reproduced from Ordnance Survey digital map data  
 © Crown copyright 2025. All rights reserved. Licence number AC0000808122

**Existing Arboricultural Information**

- A CATEGORY TREE, GROUP, HEDGE, OR WOODLAND**  
(HIGH QUALITY & VALUE)
- B CATEGORY TREE, GROUP, HEDGE, OR WOODLAND**  
(MODERATE QUALITY & VALUE)
- C CATEGORY TREE, GROUP, HEDGE, OR WOODLAND**  
(LOW QUALITY & VALUE)
- U CATEGORY TREE, GROUP, HEDGE, OR WOODLAND**  
(UNSUITABLE FOR RETENTION)
- ROOT PROTECTION AREAS (RPA)**  
(AS DEFINED BY BS 5837:2012)
- APPROXIMATE SHADING ARC**  
(AS DEFINED BY BS 5837:2012)
- VETERAN TREE MARKER**  
(INDICATES POSITION OF TREE OF VETERAN STATUS)
- ANCIENT TREE MARKER**  
(INDICATES THE POSITION OF A TREE OF ANCIENT STATUS)

Access O-007  
 Clay Lane (Norton Disney)  
 Scale - 1:1000

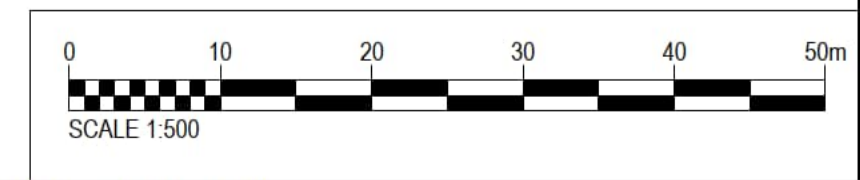
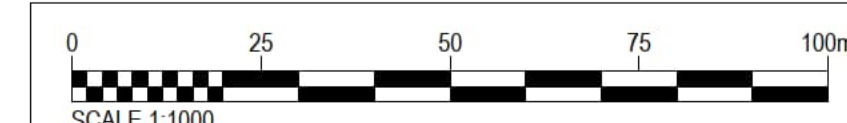

**PROJECT**  
 Fosse Green Energy

**CLIENT**  
 Fosse Green Energy Ltd

**CONSULTANT**  
 AECOM

- NOTES**
- This drawing is to be read in conjunction with all other relevant documentation.
  - Do not scale from this drawing, use only printed dimensions.
  - All dimensions in meters, all chainages, levels and coordinates are in meters unless defined otherwise.
  - This drawing is to be read in conjunction with the project Health & Safety File for any identified potential risks.
  - Vegetation to be removed denotes any vegetation features (such as hedgerows) that need to be removed to provide the required junction visibility. Any verge grassland is not to be removed but managed by the relevant maintainer to a low height so as to not impact upon junction visibility.
  - Vehicle tracking shown is indicative only, and represents approximate vehicle size & arrangement for the design vehicle shown.
  - These plans should also be read in conjunction with ES Volume 6.2 Appendix 10-H Arboricultural Impact Assessment, for details on hedgerow removal and tree protection.
  - Junction Visibility for the access is based on upon visibility parameters derived using 85th Percentile Speed Survey Data received on 1st December 2023.

**LEGEND**

- Extent of Access Footprint
- DCO Site Boundary
- Existing Public Rights of Way
- Vehicle body
- Vehicle body path
- Vehicle load path
- Vehicle load path
- Vehicle wheels path
- Edge of road
- Land not included in the DCO Site Boundary
- Junction Visibility Absolute Min.
- Junction Visibility DMRB Min.
- Vegetation to be removed DMRB Min. Vis Splay
- Indicative Hedgerow Removal Absolute Min. Vis Splay
- Indicative Hedgerow Removal for Bellmouth Access
- Approximate Structure Footprint
- Health and Safety Risk Identifier

**SHEET PLAN**

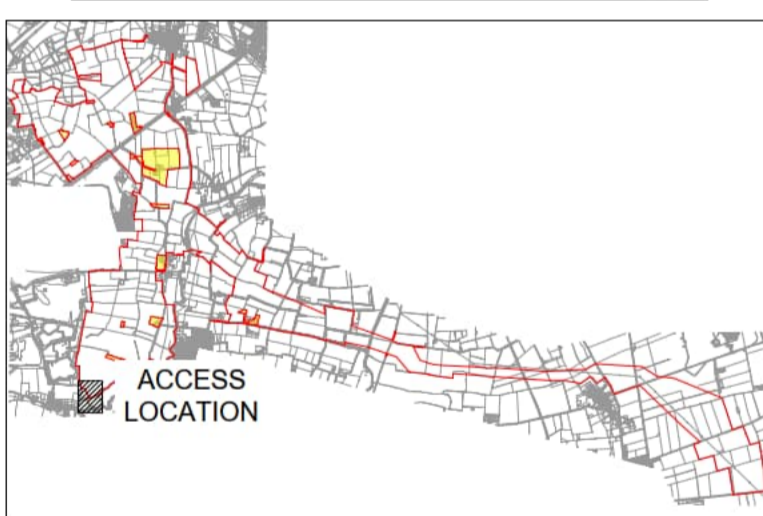

**ISSUE/REVISION**

NO.	DATE	DESCRIPTION
P01	17/07/2025	DCO SUBMISSION

**LEGISLATION**  
 Regulation 5(2)(k) Infrastructure Planning (Applications: Prescribed Forms and Procedure) Regulations 2009

**ISSUE PURPOSE**  
 DCO SUBMISSION

FIGURE NUMBER	REV.
ACCESS O-007	01

**DOCUMENT REFERENCE**  
 EN10154/APP/7.18

This drawing has been prepared for the use of AECOM's client. It may not be used, modified, reproduced or relied upon by third parties, except as agreed by AECOM or as required by law. AECOM accepts no responsibility, and denies any liability whatsoever, to any party that uses or relies on this drawing without AECOM's express written consent. Do not scale this document.

ISO A1 594mm x 841mm  
 Project No.: 60700987  
 Drawn: GT  
 Checked: MEK  
 Approved: JH  
 Date: 17/07/2025  
 Last saved by: TAYLOR/5/2025/07/17  
 Last Plotter: 2025/07/17  
 Filename: C:\USERS\TAYLOR\AECOM\FOSSE GREEN ENERGY PROJECT (AECOM) - GENERAL\900\_CAD\_GIS\913\_HIGHWAYS\DRAWINGS (CAD)\ACCESS DRAWINGS DCO\60700987-ACM-HGN-HDR-CH-0028.DWG



Reproduced from Ordnance Survey digital map data  
 © Crown copyright 2025. All rights reserved. Licence number AC0000808122

**Existing Arboricultural Information**

- A CATEGORY TREE, GROUP, HEDGE, OR WOODLAND**  
(HIGH QUALITY & VALUE)
- B CATEGORY TREE, GROUP, HEDGE, OR WOODLAND**  
(MODERATE QUALITY & VALUE)
- C CATEGORY TREE, GROUP, HEDGE, OR WOODLAND**  
(LOW QUALITY & VALUE)
- U CATEGORY TREE, GROUP, HEDGE, OR WOODLAND**  
(UNSUITABLE FOR RETENTION)
- ROOT PROTECTION AREAS (RPA)**  
(AS DEFINED BY BS 5837:2012)
- APPROXIMATE SHADING ARC**  
(AS DEFINED BY BS 5837:2012)
- VETERAN TREE MARKER**  
(INDICATES POSITION OF TREE OF VETERAN STATUS)
- ANCIENT TREE MARKER**  
(INDICATES THE POSITION OF A TREE OF ANCIENT STATUS)

This drawing has been prepared for the use of AECOM's client. It may not be used, modified, reproduced or relied upon by third parties, except as agreed by AECOM or as required by law. AECOM accepts no responsibility, and denies any liability whatsoever, to any party that uses or relies on this drawing without AECOM's express written consent. Do not scale this document.



**PROJECT**  
 Fosse Green Energy

**CLIENT**  
 Fosse Green Energy Ltd

**CONSULTANT**  
 AECOM

- NOTES**
- This drawing is to be read in conjunction with all other relevant documentation.
  - Do not scale from this drawing, use only printed dimensions.
  - All dimensions in meters, all chainages, levels and coordinates are in meters unless defined otherwise.
  - This drawing is to be read in conjunction with the project Health & Safety File for any identified potential risks.
  - Vegetation to be removed denotes any vegetation features (such as hedgerows) that need to be removed to provide the required junction visibility. Any verge grassland is not to be removed but managed by the relevant maintainer to a low height so as to not impact upon junction visibility.
  - Vehicle tracking shown is indicative only, and represents approximate vehicle size & arrangement for the design vehicle shown.
  - These plans should also be read in conjunction with ES Volume 6.2 Appendix 10-H Arboricultural Impact Assessment, for details on hedgerow removal and tree protection

**LEGEND**

- Extent of Access Footprint
- DCO Site Boundary
- Existing Public Rights of Way
- Vehicle body
- Vehicle body path
- Vehicle load
- Vehicle load path
- Vehicle wheels path
- Edge of road
- Land not included in the DCO Site Boundary
- Junction Visibility Absolute Min.
- Vegetation to be removed Absolute Min. Vis Splay
- Junction Visibility DMRB Min.
- Vegetation to be removed DMRB Min. Vis Splay
- Indicative Hedgerow Removal Absolute Min. Vis Splay
- Indicative Hedgerow Removal for Bellmouth Access
- Approximate Structure Footprint
- Health and Safety Risk Identifier



**ISSUE/REVISION**

NO	DATE	DESCRIPTION
P01	17/07/2025	DCO SUBMISSION

**LEGISLATION**  
 Regulation 5(2)(k) Infrastructure Planning  
 (Applications: Prescribed Forms and Procedure) Regulations 2009

**ISSUE PURPOSE**  
 DCO SUBMISSION

FIGURE NUMBER	REV.
ACCESS E-001	01

**DOCUMENT REFERENCE**  
 EN010154/APP/7.18

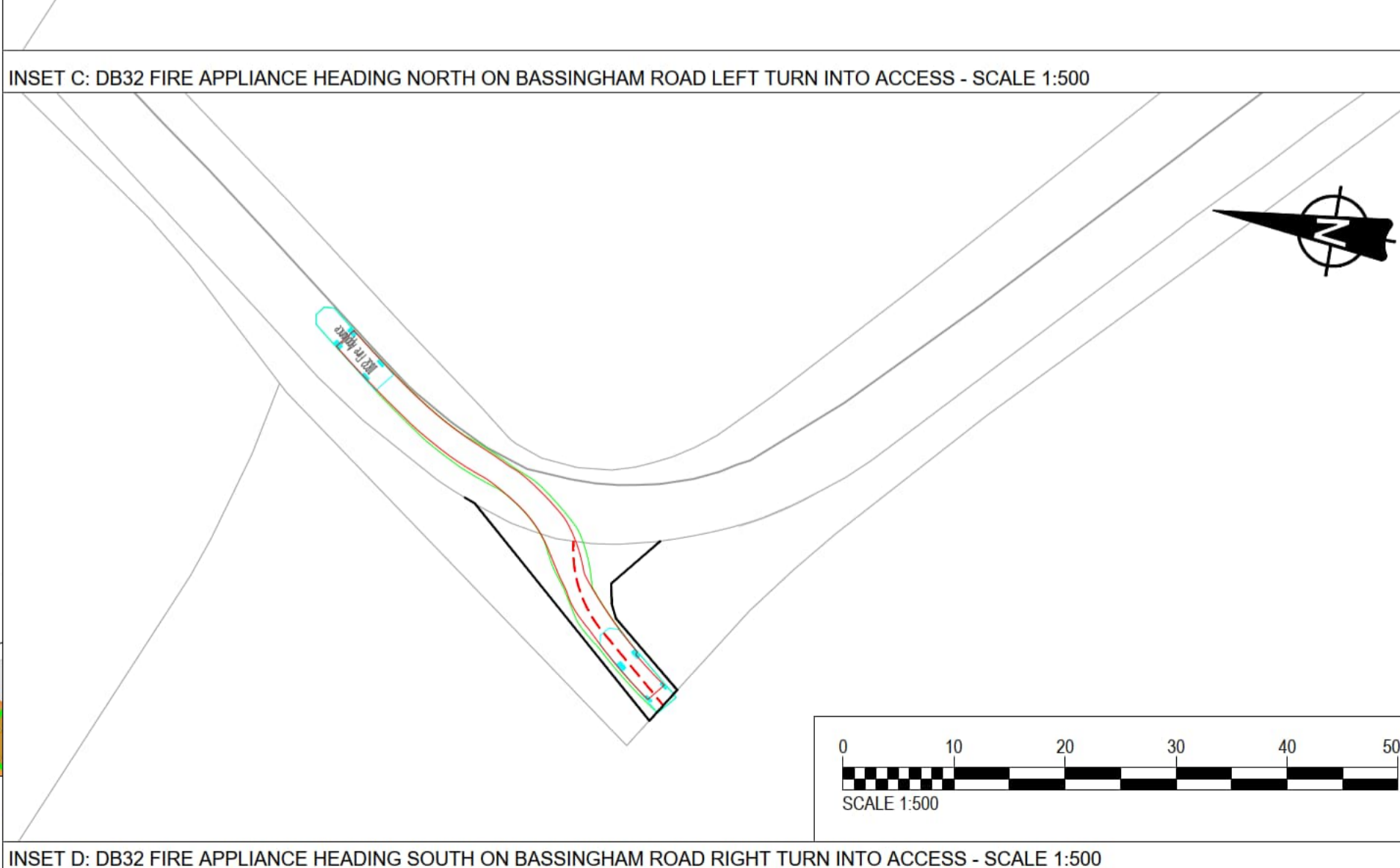
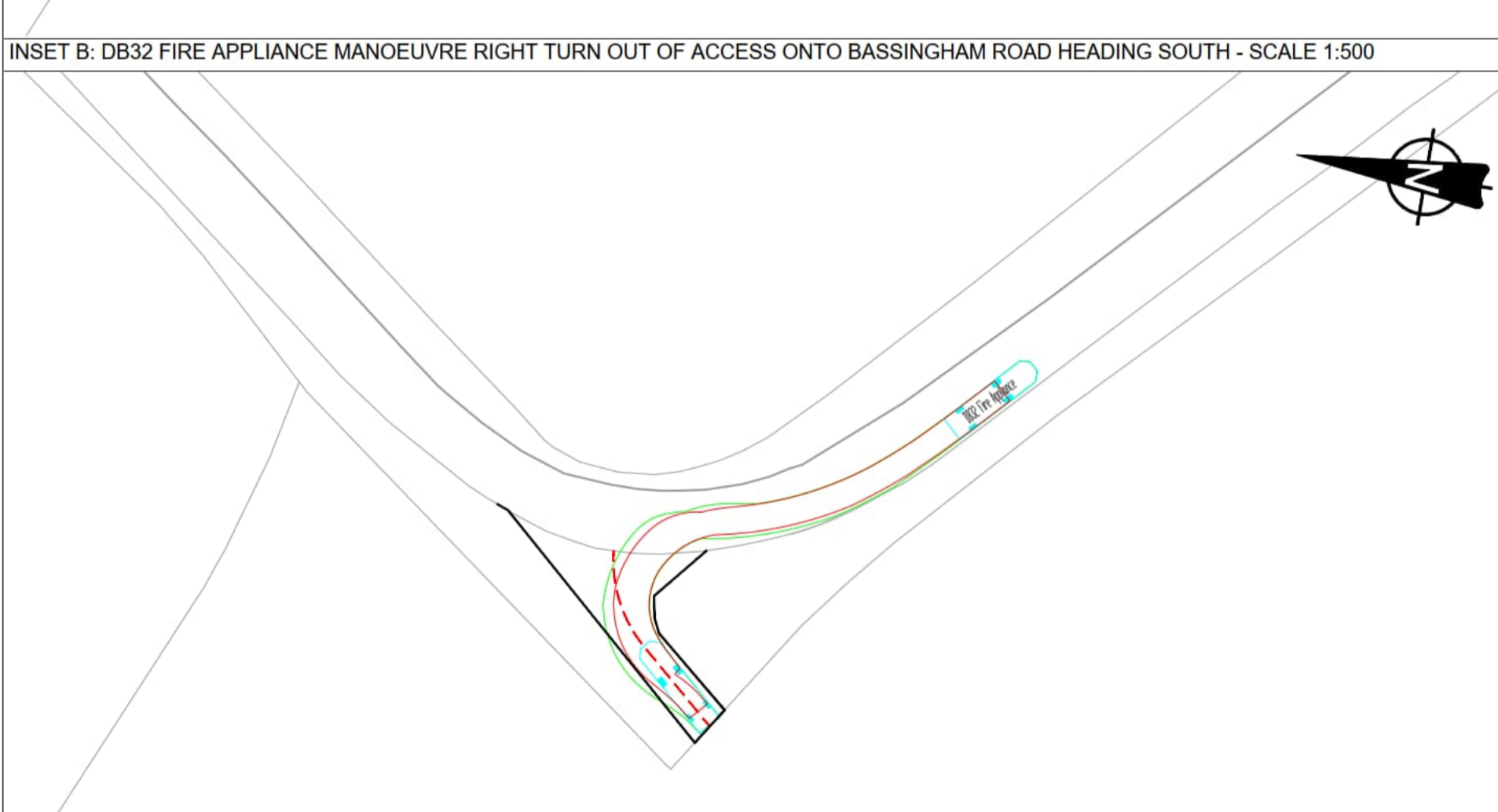
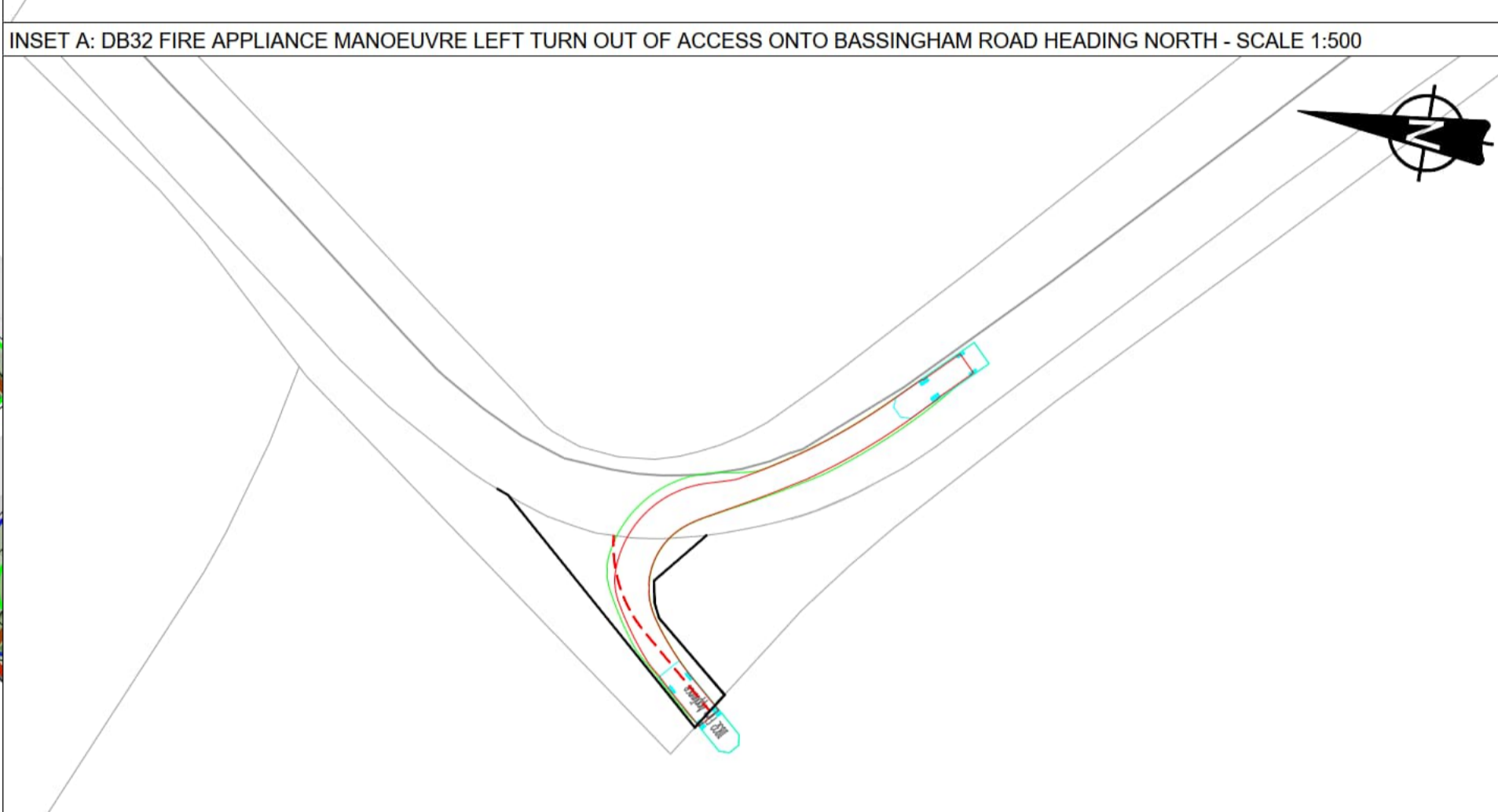
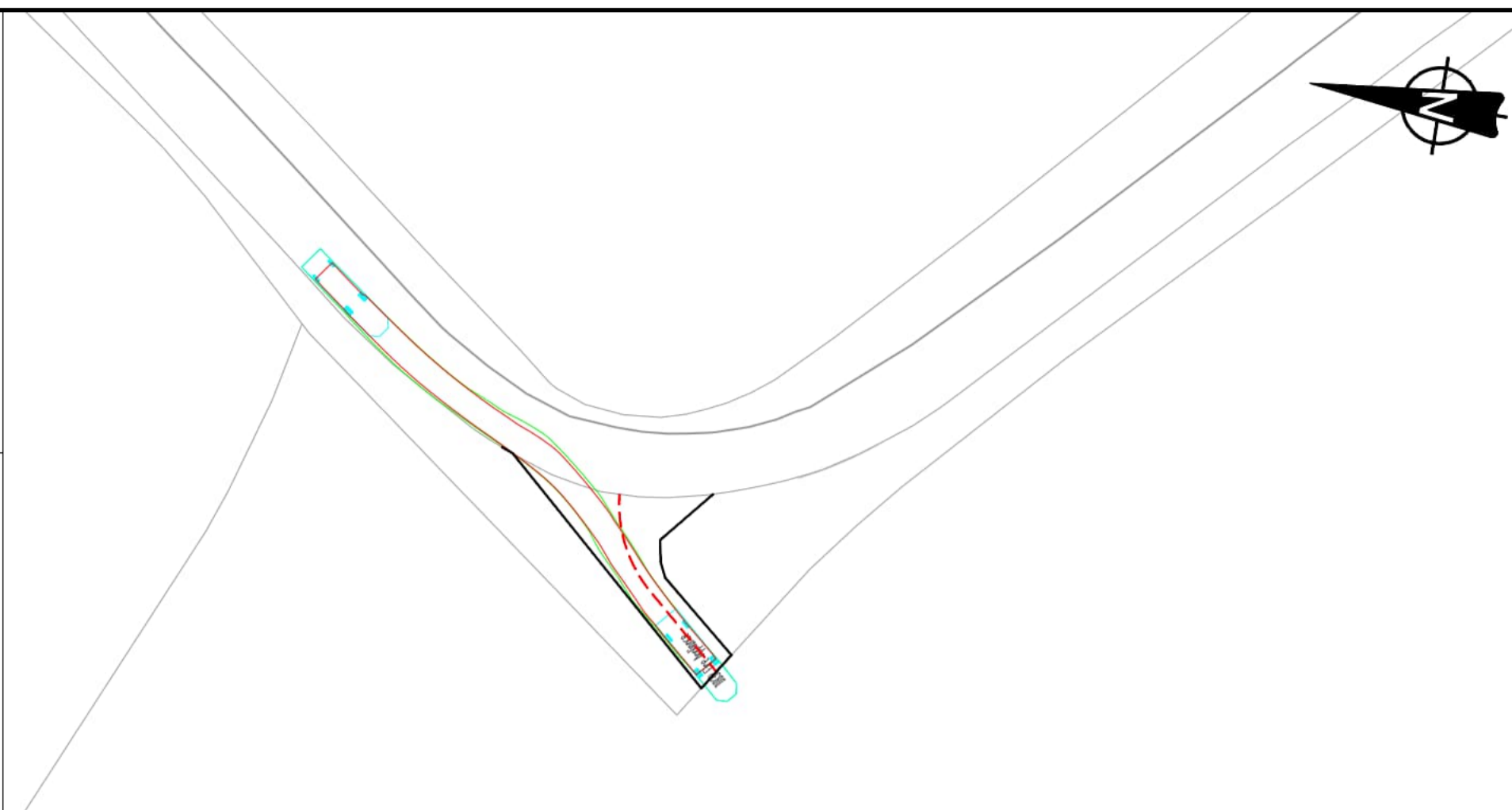
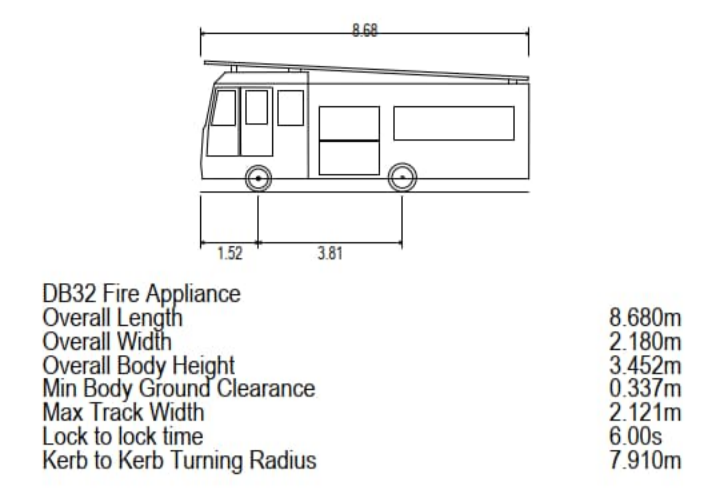
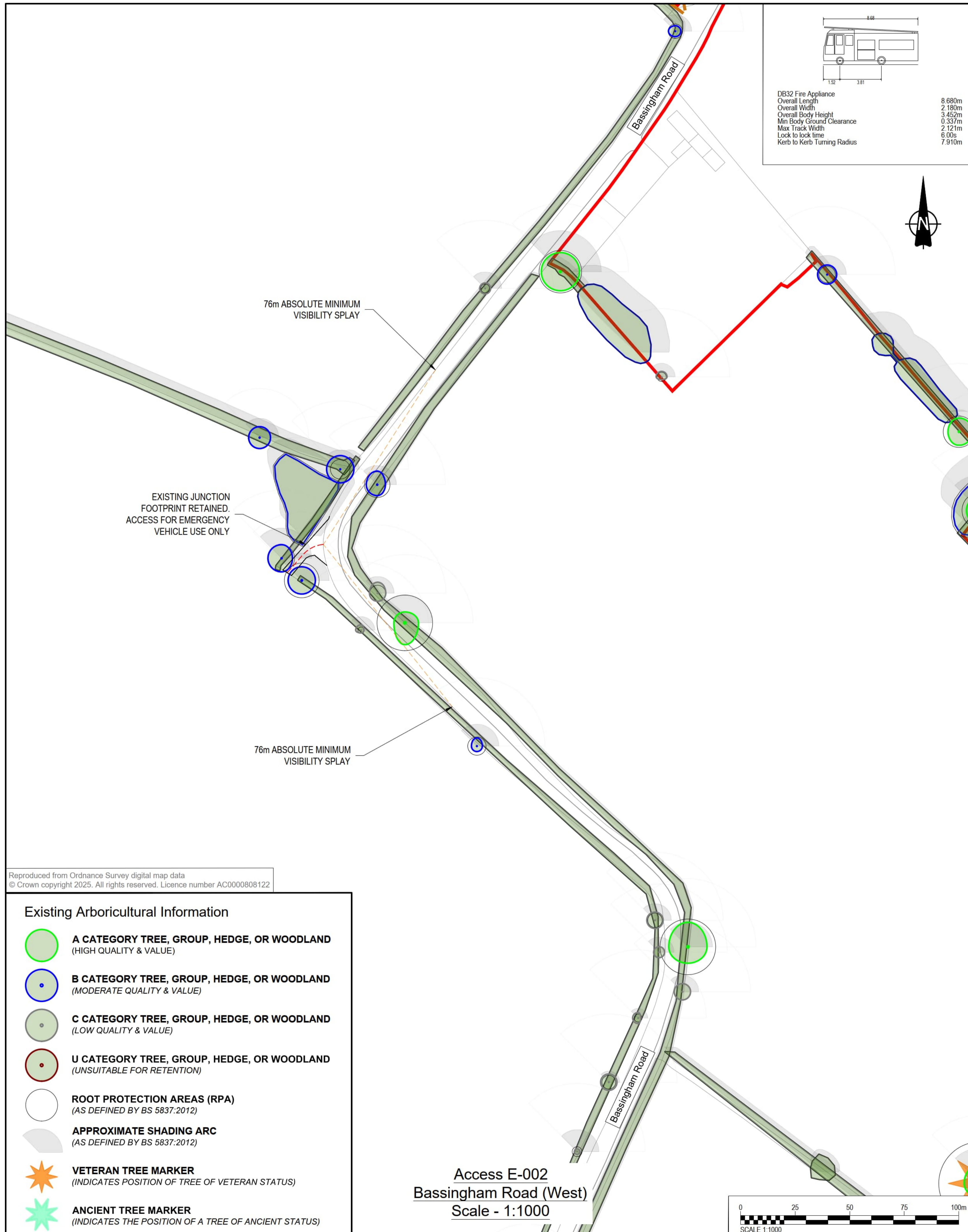

Reproduced from Ordnance Survey digital map data  
 © Crown copyright 2025. All rights reserved. Licence number AC0000808122

**Existing Arboricultural Information**

- A CATEGORY TREE, GROUP, HEDGE, OR WOODLAND**  
(HIGH QUALITY & VALUE)
- B CATEGORY TREE, GROUP, HEDGE, OR WOODLAND**  
(MODERATE QUALITY & VALUE)
- C CATEGORY TREE, GROUP, HEDGE, OR WOODLAND**  
(LOW QUALITY & VALUE)
- U CATEGORY TREE, GROUP, HEDGE, OR WOODLAND**  
(UNSUITABLE FOR RETENTION)
- ROOT PROTECTION AREAS (RPA)**  
(AS DEFINED BY BS 5837:2012)
- APPROXIMATE SHADING ARC**  
(AS DEFINED BY BS 5837:2012)
- VETERAN TREE MARKER**  
(INDICATES POSITION OF TREE OF VETERAN STATUS)
- ANCIENT TREE MARKER**  
(INDICATES THE POSITION OF A TREE OF ANCIENT STATUS)

Access E-002  
 Bassingham Road (West)  
 Scale - 1:1000

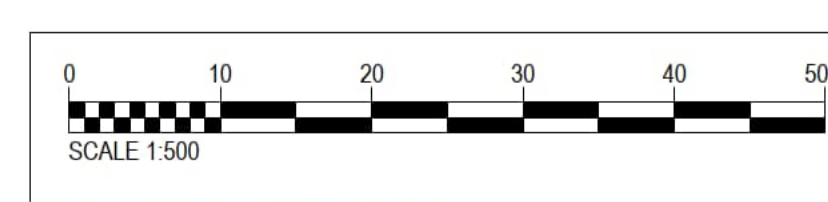
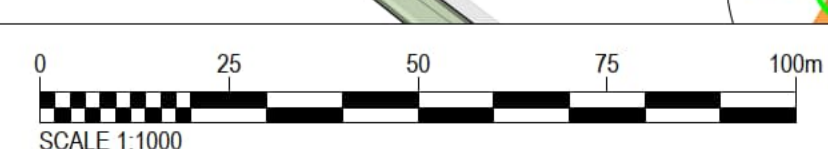

**PROJECT**  
 Fosse Green Energy

**CLIENT**  
 Fosse Green Energy Ltd

**CONSULTANT**  
 AECOM

- NOTES**
- This drawing is to be read in conjunction with all other relevant documentation.
  - Do not scale from this drawing, use only printed dimensions.
  - All dimensions in meters, all chainages, levels and coordinates are in meters unless defined otherwise.
  - This drawing is to be read in conjunction with the project Health & Safety File for any identified potential risks.
  - Vegetation to be removed denotes any vegetation features (such as hedgerows) that need to be removed to provide the required junction visibility. Any verge grassland is not to be removed but managed by the relevant maintainer to a low height so as to not impact upon junction visibility.
  - Vehicle tracking shown is indicative only, and represents approximate vehicle size & arrangement for the design vehicle shown.
  - These plans should also be read in conjunction with ES Volume 6.2 Appendix 10-H Arboricultural Impact Assessment, for details on hedgerow removal and tree protection.
  - Junction Visibility for the access is based on upon visibility parameters derived using 85th Percentile Speed Survey Data received on 1st December 2023.

- LEGEND**
- Extent of Access Footprint
  - DCO Site Boundary
  - Existing Public Rights of Way
  - Vehicle body
  - Vehicle body path
  - Vehicle load
  - Vehicle load path
  - Vehicle wheels path
  - Edge of road
  - Land not included in the DCO Site Boundary
  - Junction Visibility Absolute Min.
  - Junction Visibility DMRB Min.
  - Vegetation to be removed DMRB Min. Vis Splay
  - Indicative Hedgerow Removal Absolute Min. Vis Splay
  - Indicative Hedgerow Removal for Bellmouth Access
  - Approximate Structure Footprint
  - Health and Safety Risk Identifier

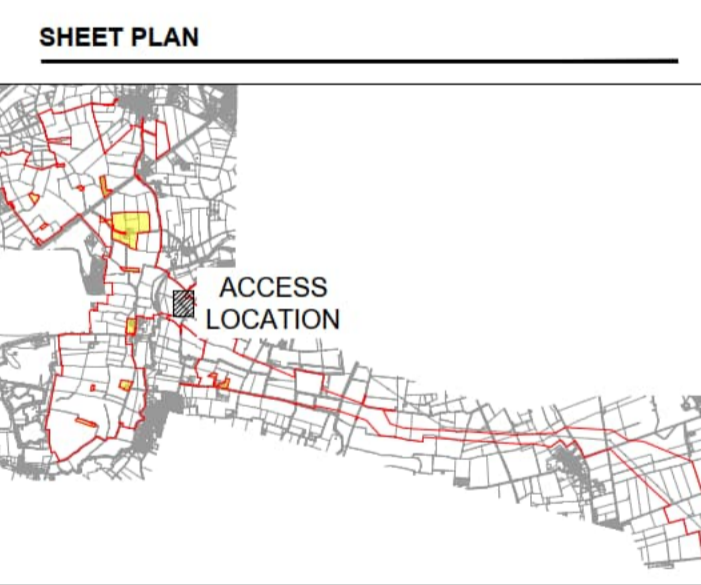

**ISSUE/REVISION**

NO.	DATE	DESCRIPTION
P01	17/07/2025	DCO SUBMISSION

**LEGISLATION**  
 Regulation 5(2)(k) Infrastructure Planning  
 (Applications: Prescribed Forms and Procedure) Regulations 2009

**ISSUE PURPOSE**  
 DCO SUBMISSION

FIGURE NUMBER	REV.
ACCESS E-002	01

**DOCUMENT REFERENCE**  
 EN010154/APP/7.18

This drawing has been prepared for the use of AECOM's client. It may not be used, modified, reproduced or relied upon by third parties, except as agreed by AECOM or as required by law. AECOM accepts no responsibility, and denies any liability whatsoever, to any party that uses or relies on this drawing without AECOM's express written consent. Do not scale this document.

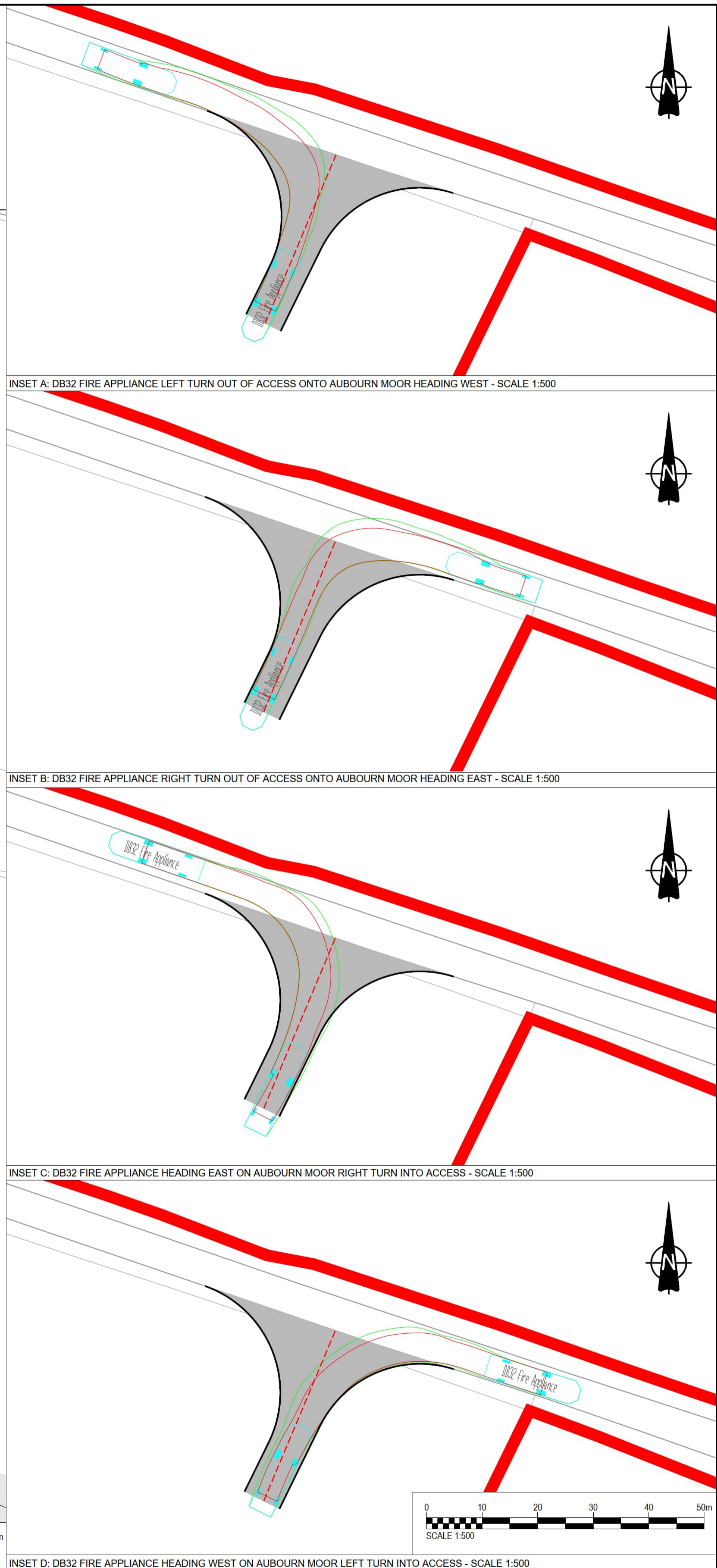
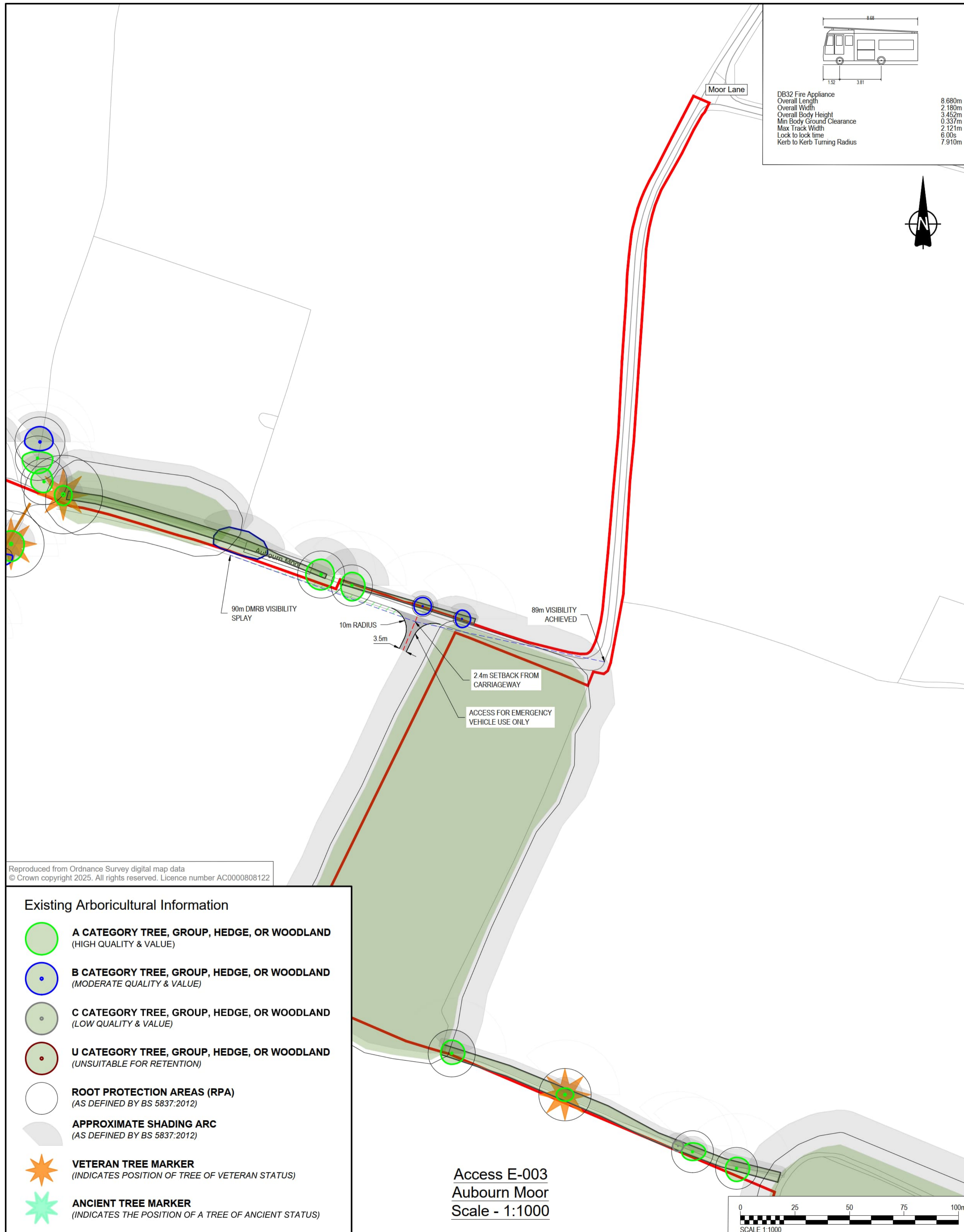

**PROJECT**  
 Fosse Green Energy

**CLIENT**  
 Fosse Green Energy Ltd

**CONSULTANT**  
 AECOM

- NOTES**
- This drawing is to be read in conjunction with all other relevant documentation.
  - Do not scale from this drawing, use only printed dimensions.
  - All dimensions in meters, all chainages, levels and coordinates are in meters unless defined otherwise.
  - This drawing is to be read in conjunction with the project Health & Safety File for any identified potential risks.
  - Vegetation to be removed denotes any vegetation features (such as hedgerows) that need to be removed to provide the required junction visibility. Any verge grassland is not to be removed but managed by the relevant maintainer to a low height so as to not impact upon junction visibility.
  - Vehicle tracking shown is indicative only, and represents approximate vehicle size & arrangement for the design vehicle shown.
  - These plans should also be read in conjunction with ES Volume 6.2 Appendix 10-H Arboricultural Impact Assessment, for details on hedgerow removal and tree protection.
  - Junction Visibility for the access is based on DMRB CD109, Table 2.10.

- LEGEND**
- Extent of Access Footprint
  - DCO Site Boundary
  - Existing Public Rights of Way
  - Vehicle body
  - Vehicle body path
  - Vehicle load
  - Vehicle load path
  - Vehicle wheels path
  - Edge of road
  - Land not included in the DCO Site Boundary
  - Junction Visibility Absolute Min.
  - Vegetation to be removed Absolute Min. Vis Splay
  - Junction Visibility DMRB Min.
  - Vegetation to be removed DMRB Min. Vis Splay
  - Indicative Hedgerow Removal Absolute Min. Vis Splay
  - Indicative Hedgerow Removal for Bellmouth Access
  - Approximate Structure Footprint
  - Health and Safety Risk Identifier

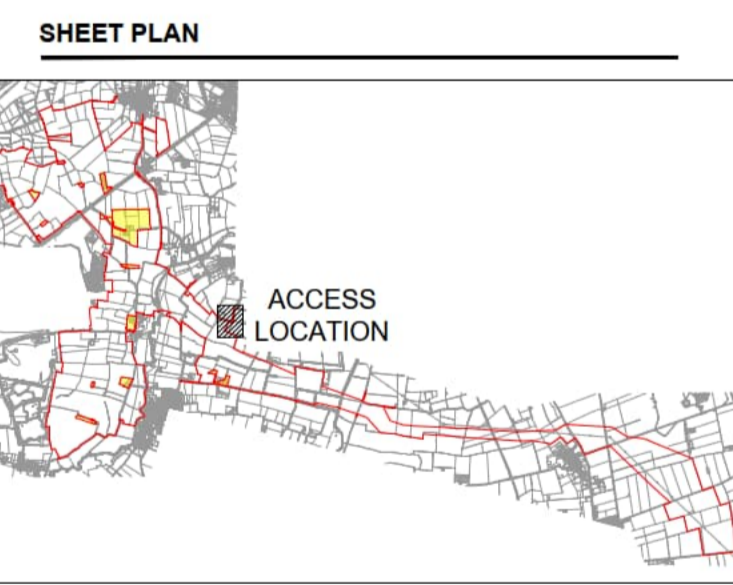

**ISSUE/REVISION**

NO.	DATE	DESCRIPTION
P01	17/07/2025	DCO SUBMISSION

**LEGISLATION**  
 Regulation 5(2)(k) Infrastructure Planning (Applications: Prescribed Forms and Procedure) Regulations 2009

**ISSUE PURPOSE**  
 DCO SUBMISSION

FIGURE NUMBER	REV.
ACCESS E-003	01

**DOCUMENT REFERENCE**  
 EN010154/APP/7.18

Reproduced from Ordnance Survey digital map data © Crown copyright 2025. All rights reserved. Licence number AC0000808122

**Existing Arboricultural Information**

- A CATEGORY TREE, GROUP, HEDGE, OR WOODLAND** (HIGH QUALITY & VALUE)
- B CATEGORY TREE, GROUP, HEDGE, OR WOODLAND** (MODERATE QUALITY & VALUE)
- C CATEGORY TREE, GROUP, HEDGE, OR WOODLAND** (LOW QUALITY & VALUE)
- U CATEGORY TREE, GROUP, HEDGE, OR WOODLAND** (UNSUITABLE FOR RETENTION)
- ROOT PROTECTION AREAS (RPA)** (AS DEFINED BY BS 5837:2012)
- APPROXIMATE SHADING ARC** (AS DEFINED BY BS 5837:2012)
- VETERAN TREE MARKER** (INDICATES POSITION OF TREE OF VETERAN STATUS)
- ANCIENT TREE MARKER** (INDICATES THE POSITION OF A TREE OF ANCIENT STATUS)

Access E-003  
 Aubourn Moor  
 Scale - 1:1000

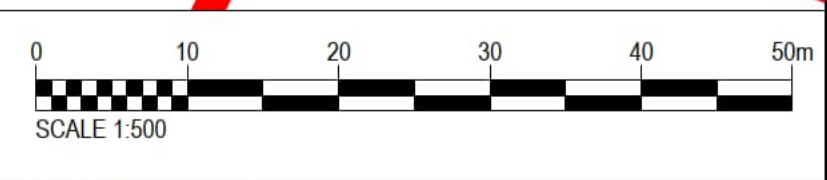
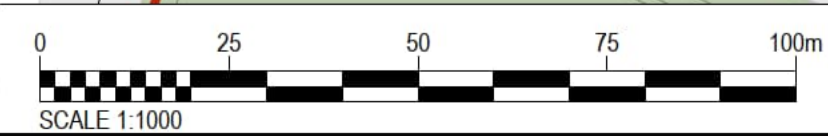

This drawing has been prepared for the use of AECOM's client. It may not be used, modified, reproduced or relied upon by third parties, except as agreed by AECOM or as required by law. AECOM accepts no responsibility, and denies any liability whatsoever, to any party that uses or relies on this drawing without AECOM's express written consent. Do not scale this document.

ISO A1 594mm x 841mm  
 Project No.: 60700987 Drawn: GT Checked: MEK/Approved: JH Date: 17/07/2025  
 Last saved by: TAYLOR/5/2025/07/17 Last Plotfile: 2025/07/17  
 Filename: C:\USERS\TAYLOR\AECOM\FOSSE GREEN ENERGY PROJECT (AECOM) - GENERAL\900\_CAD\_GIS\913\_HIGHWAYS\DRAWINGS (CAD)\ACCESS DRAWINGS DCO\60700987-ACM-HGN-DR-CH-0031.DWG

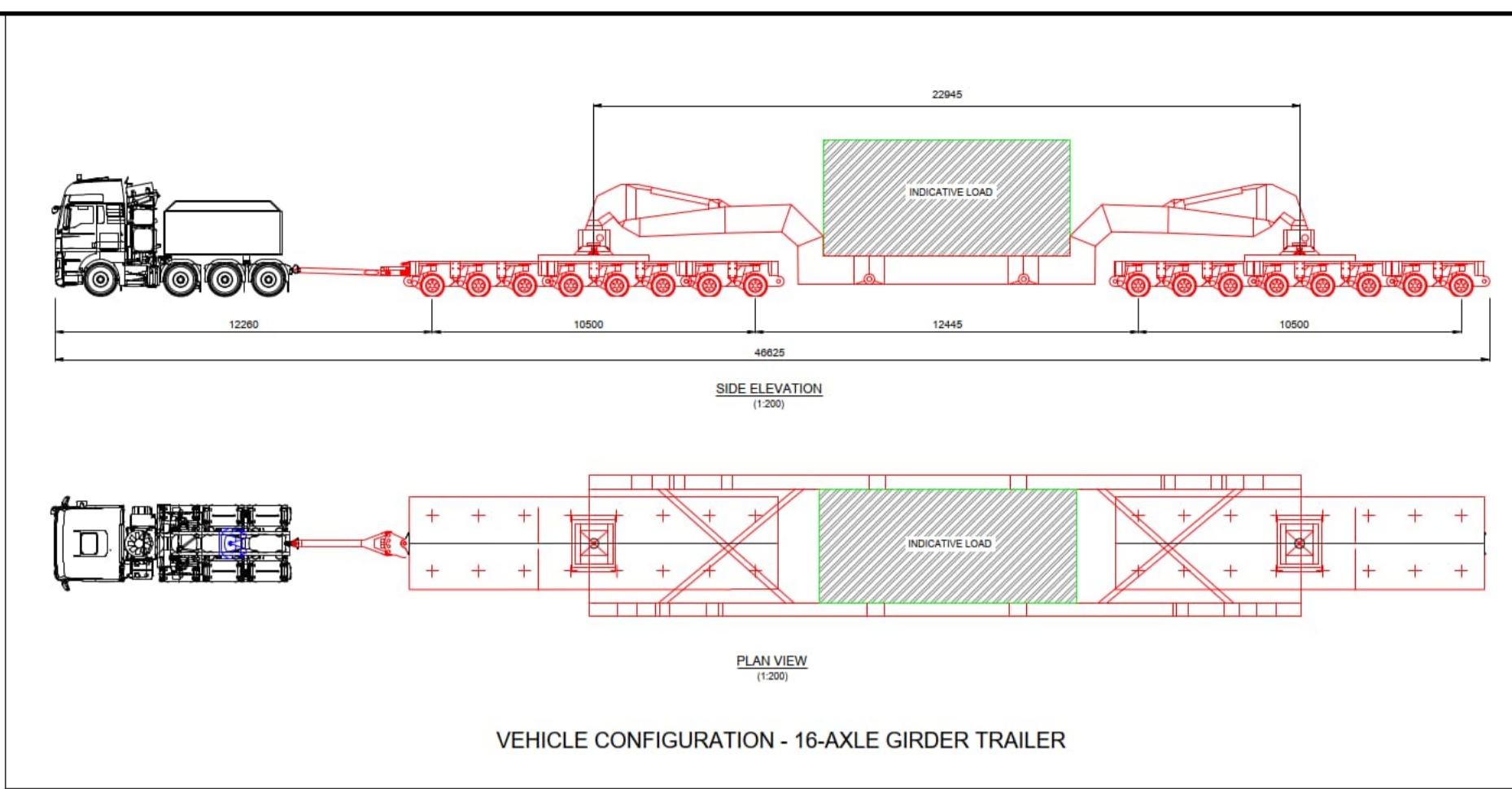
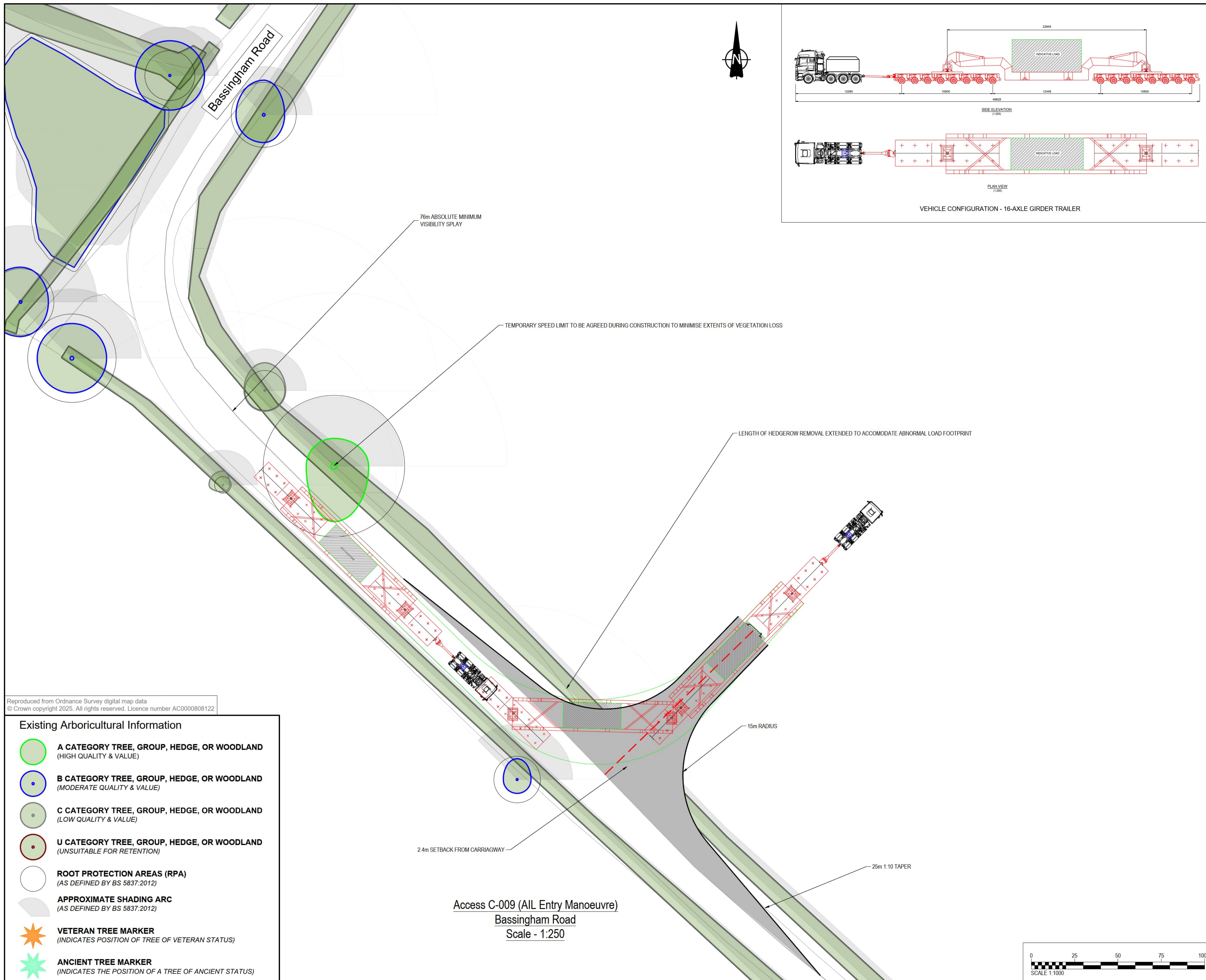

Reproduced from Ordnance Survey digital map data  
 © Crown copyright 2025. All rights reserved. Licence number AC0000808122

**Existing Arboricultural Information**

- A CATEGORY TREE, GROUP, HEDGE, OR WOODLAND**  
(HIGH QUALITY & VALUE)
- B CATEGORY TREE, GROUP, HEDGE, OR WOODLAND**  
(MODERATE QUALITY & VALUE)
- C CATEGORY TREE, GROUP, HEDGE, OR WOODLAND**  
(LOW QUALITY & VALUE)
- U CATEGORY TREE, GROUP, HEDGE, OR WOODLAND**  
(UNSUITABLE FOR RETENTION)
- ROOT PROTECTION AREAS (RPA)**  
(AS DEFINED BY BS 5837:2012)
- APPROXIMATE SHADING ARC**  
(AS DEFINED BY BS 5837:2012)
- VETERAN TREE MARKER**  
(INDICATES POSITION OF TREE OF VETERAN STATUS)
- ANCIENT TREE MARKER**  
(INDICATES THE POSITION OF A TREE OF ANCIENT STATUS)

- NOTES**
- This drawing is to be read in conjunction with all other relevant documentation.
  - Do not scale from this drawing, use only printed dimensions.
  - All dimensions in meters, all chainages, levels and coordinates are in meters unless defined otherwise.
  - This drawing is to be read in conjunction with the project Health & Safety File for any identified potential risks.
  - Vegetation to be removed denotes any vegetation features (such as hedgerows) that need to be removed to provide the required junction visibility. Any verge grassland is not to be removed but managed by the relevant maintainer to a low height so as to not impact upon junction visibility.
  - Vehicle tracking shown is indicative only, and represents approximate vehicle size & arrangement for the design vehicle shown.
  - These plans should also be read in conjunction with ES Volume 6.2 Appendix 10-H Arboricultural Impact Assessment, for details on hedgerow removal and tree protection

- LEGEND**
- Extent of Access Footprint
  - DCO Site Boundary
  - Existing Public Rights of Way
  - Vehicle body
  - Vehicle body path
  - Vehicle load
  - Vehicle load path
  - Vehicle wheels path
  - Edge of road
  - Land not included in the DCO Site Boundary
  - Junction Visibility Absolute Min.
  - Vegetation to be removed Absolute Min. Vis Splay
  - Junction Visibility DMRB Min.
  - Vegetation to be removed DMRB Min. Vis Splay
  - Indicative Hedgerow Removal Absolute Min. Vis Splay
  - Indicative Hedgerow Removal for Bellmouth Access
  - Approximate Structure Footprint
  - Health and Safety Risk Identifier

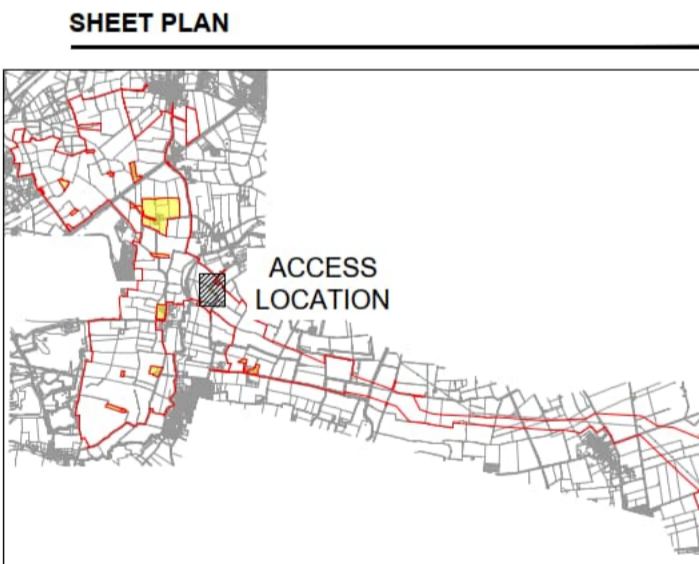

**ISSUE/REVISION**

NO.	DATE	DESCRIPTION
P01	17/07/2025	DCO SUBMISSION
I/R	DATE	DESCRIPTION

**LEGISLATION**  
 Regulation 5(2)(k) Infrastructure Planning (Applications: Prescribed Forms and Procedure) Regulations 2009

**ISSUE PURPOSE**  
 DCO SUBMISSION

FIGURE NUMBER	REV.
ACCESS C-009	01

**DOCUMENT REFERENCE**  
 EN010154/APP/7.18

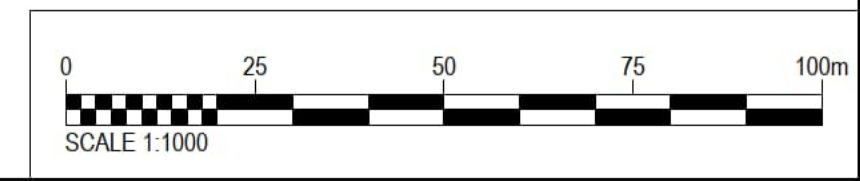

This drawing has been prepared for the use of AECOM's client. It may not be used, modified, reproduced or relied upon by third parties, except as agreed by AECOM, or as required by law. AECOM accepts no responsibility, and denies any liability whatsoever, to any party that uses or relies on this drawing without AECOM's express written consent. Do not scale this document.

# Annex C Indicative Abnormal Vehicle Route Access Swept Paths and Routing (Principal Site)

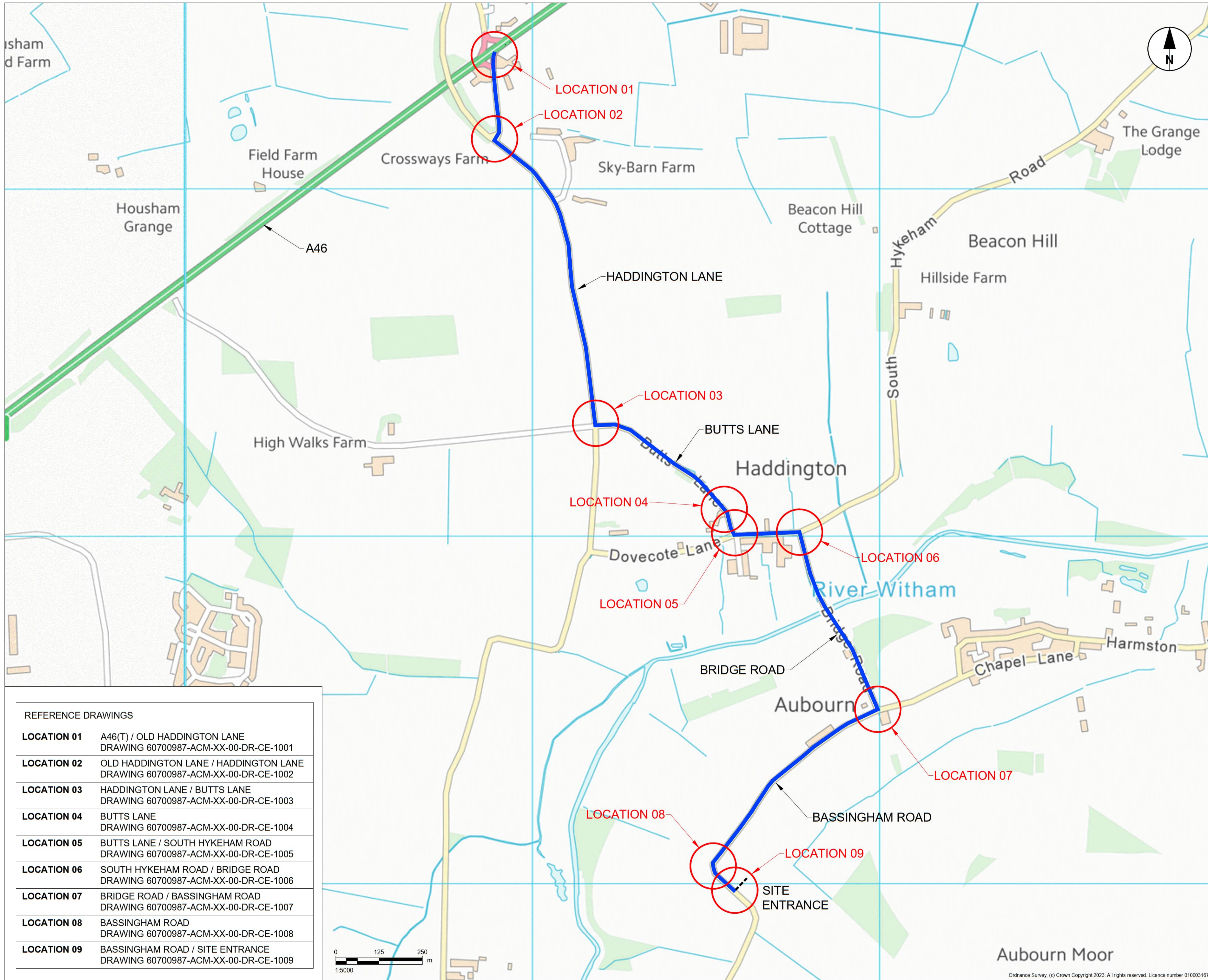

ISSUE/REVISION			
Rev	Date	Description	Dr/Chk/Appr
-	12.12.23	FIRST ISSUE	EP/CGY/MW

REFERENCE DRAWINGS	
<b>LOCATION 01</b>	A46(T) / OLD HADDINGTON LANE DRAWING 60700987-ACM-XX-00-DR-CE-1001
<b>LOCATION 02</b>	OLD HADDINGTON LANE / HADDINGTON LANE DRAWING 60700987-ACM-XX-00-DR-CE-1002
<b>LOCATION 03</b>	HADDINGTON LANE / BUTTS LANE DRAWING 60700987-ACM-XX-00-DR-CE-1003
<b>LOCATION 04</b>	BUTTS LANE DRAWING 60700987-ACM-XX-00-DR-CE-1004
<b>LOCATION 05</b>	BUTTS LANE / SOUTH HYKEHAM ROAD DRAWING 60700987-ACM-XX-00-DR-CE-1005
<b>LOCATION 06</b>	SOUTH HYKEHAM ROAD / BRIDGE ROAD DRAWING 60700987-ACM-XX-00-DR-CE-1006
<b>LOCATION 07</b>	BRIDGE ROAD / BASSINGHAM ROAD DRAWING 60700987-ACM-XX-00-DR-CE-1007
<b>LOCATION 08</b>	BASSINGHAM ROAD DRAWING 60700987-ACM-XX-00-DR-CE-1008
<b>LOCATION 09</b>	BASSINGHAM ROAD / SITE ENTRANCE DRAWING 60700987-ACM-XX-00-DR-CE-1009

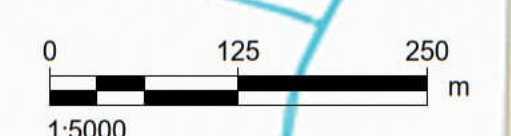

Aubourn Moor

This drawing has been prepared for the use of AECOM's client. It may not be used, modified, reproduced or relied upon by third parties, except as agreed by AECOM or as required by law. AECOM accepts no responsibility, and denies any liability, whatsoever, to any party that uses or relies on this drawing without AECOM's express written consent. Do not scale this document. All measurements must be obtained from the scaled dimensions.

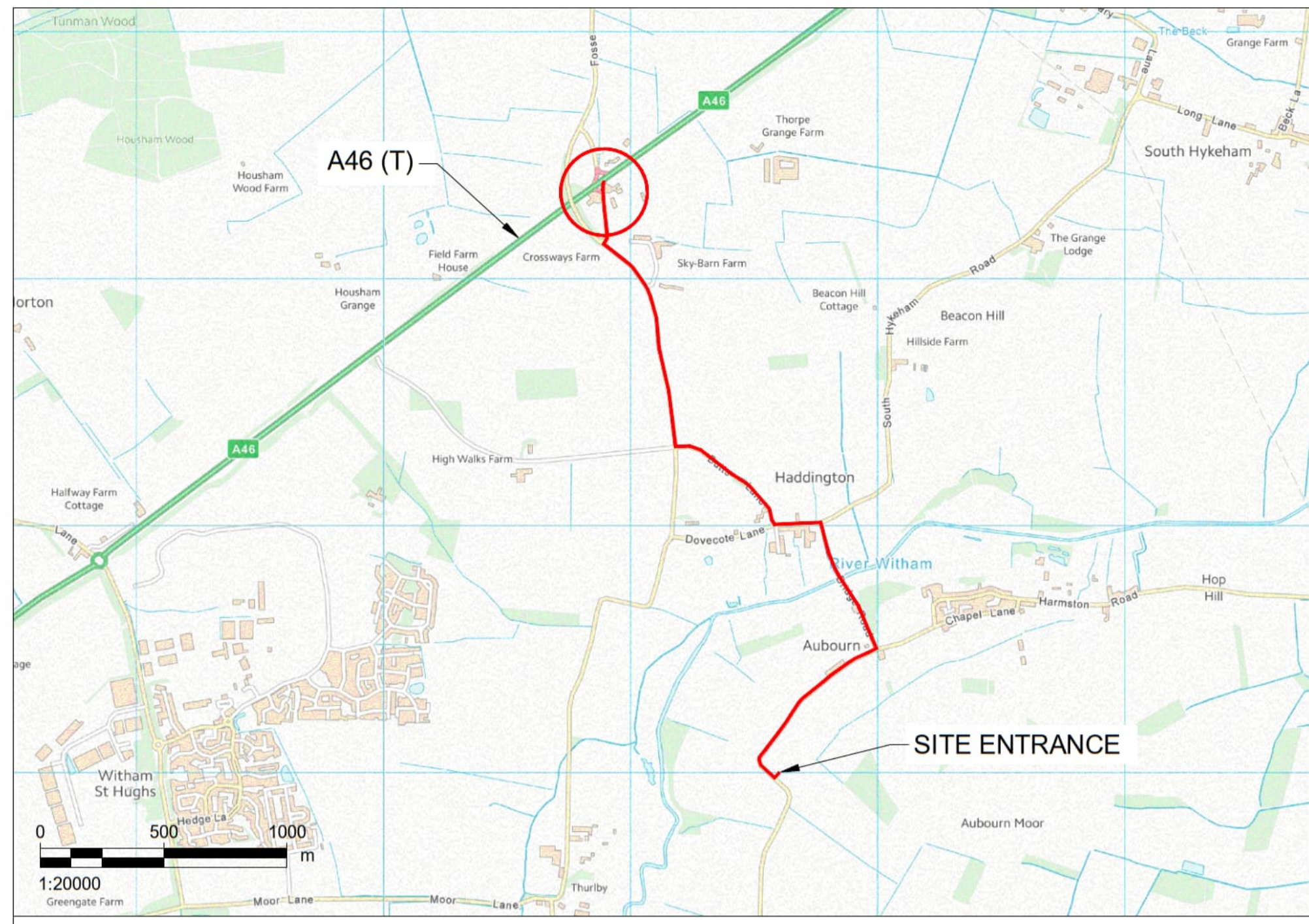

- NOTES:**
1. VEHICLE TRACKING SHOWN IS INDICATIVE ONLY, AND REPRESENTS APPROXIMATE VEHICLE SIZE / ARRANGEMENT ANTICIPATED FOR TRANSFORMER DELIVERY. SPECIFIC VEHICLE SIZE / ARRANGEMENT TO BE DETERMINED BY EQUIPMENT SUPPLIER AND HEAVY HAULAGE CONTRACTOR.
  2. DEFINITIVE VEHICLE TRACKING OF SPECIFIC DELIVERY VEHICLE REQUIRES TO BE CARRIED OUT BY THE HEAVY HAULAGE CONTRACTOR, TO ENSURE THE DESIRED MANOEUVRES ARE ACHIEVABLE, AND TO CONFIRM ANY REQUIRED ROAD WIDENING, TEMPORARY WORKS, etc.
  3. THIS DRAWING IS BASED ON ORDNANCE SURVEY MAPPING, AND AS SUCH IS INDICATIVE ONLY. ALL LINEWORK, DIMENSIONS, STREET FURNITURE, etc. ARE APPROXIMATE ONLY.
  4. THIS DRAWING IS BASED ON THE ASSUMED AIL ROUTE TO SITE. FINAL ROUTE TO BE DETERMINED BY THE HEAVY HAULAGE CONTRACTOR.

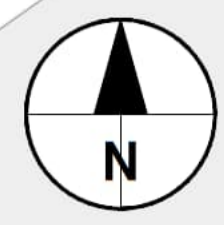
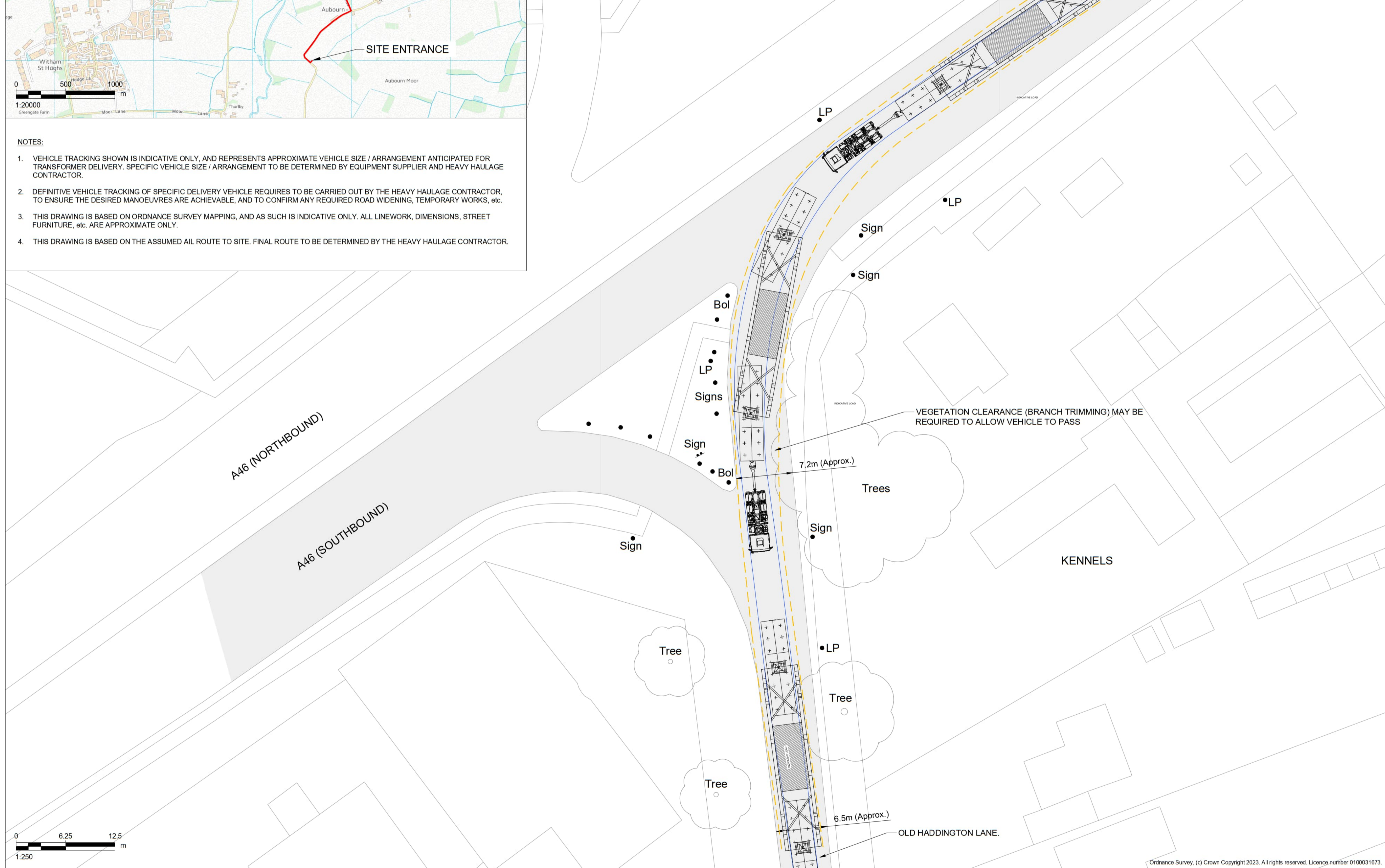
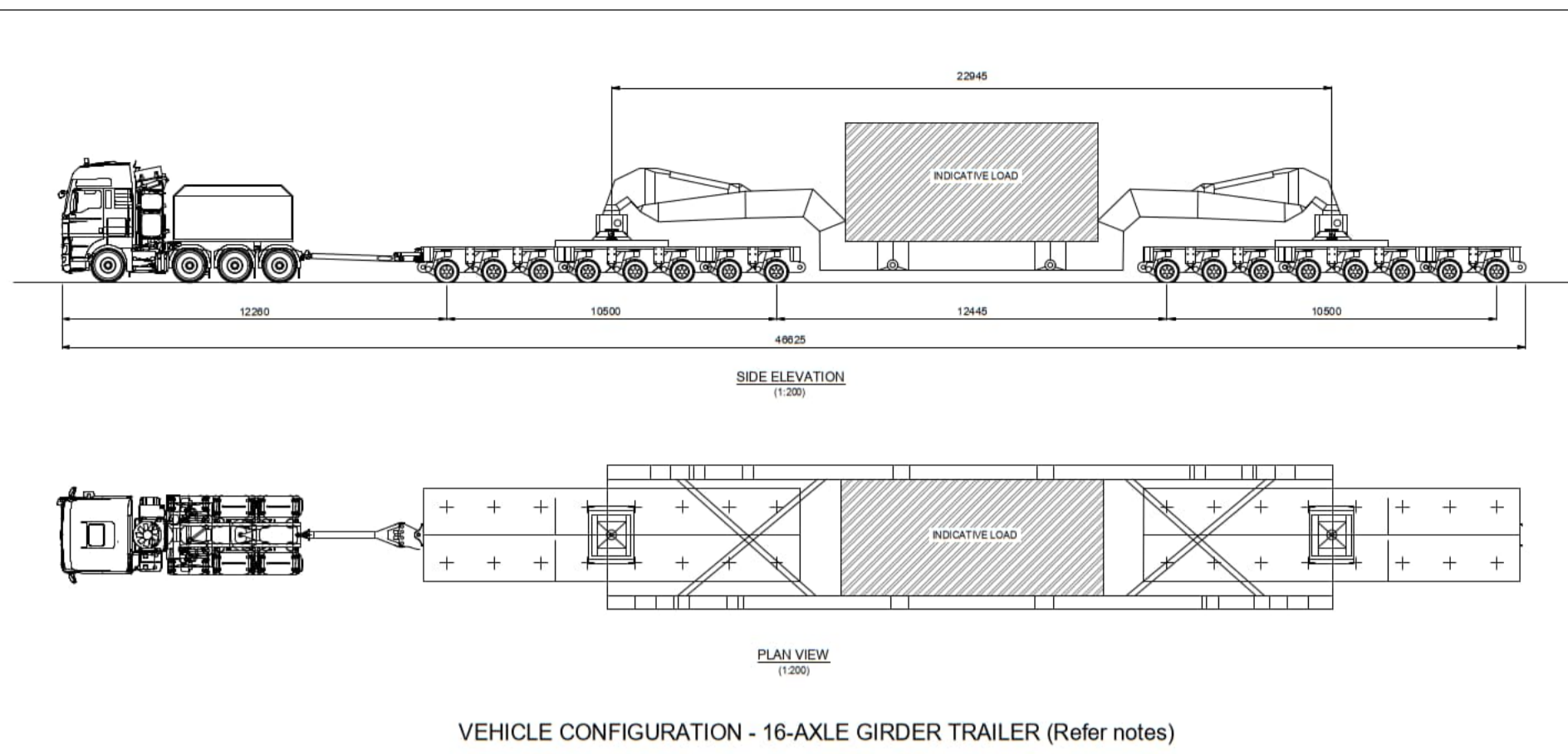

- Notes**
1. ALL DIMENSIONS IN METRES UNLESS STATED OTHERWISE.
  2. FOR OVERVIEW OF PROPOSED ABNORMAL LOAD ROUTE, REFER DRAWING 60700987-ACM-XX-00-DR-CE-1000.

- KEY**
- PROPOSED AIL ROUTE TO SITE
  - EXISTING CARRIAGEWAY
  - APPROXIMATE VEHICLE WHEEL TRACK
  - APPROXIMATE OVER-SAIL OF VEHICLE BODY

ISSUE/REVISION			
Rev	Date	Description	Dm/Chk/Appr
-	12.12.23	FIRST ISSUE	EP/CGY/MW

This drawing has been prepared for the use of AECOM's client. It may not be used, modified, reproduced or relied upon by third parties, except as agreed by AECOM or as required by law. AECOM accepts no responsibility, and denies any liability, whatsoever, to any party that uses or relies on this drawing without AECOM's express written consent. Do not scale this document. All measurements must be obtained from the stated dimensions.

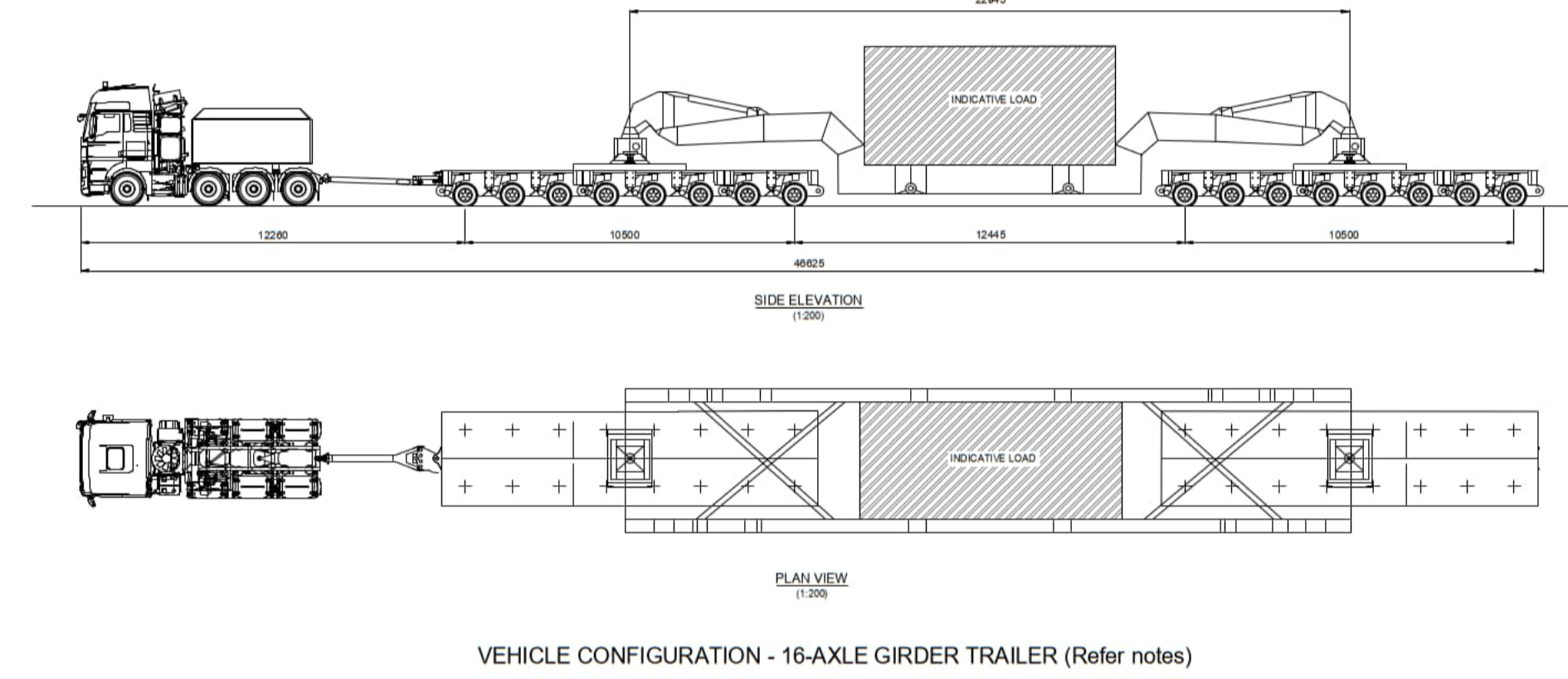
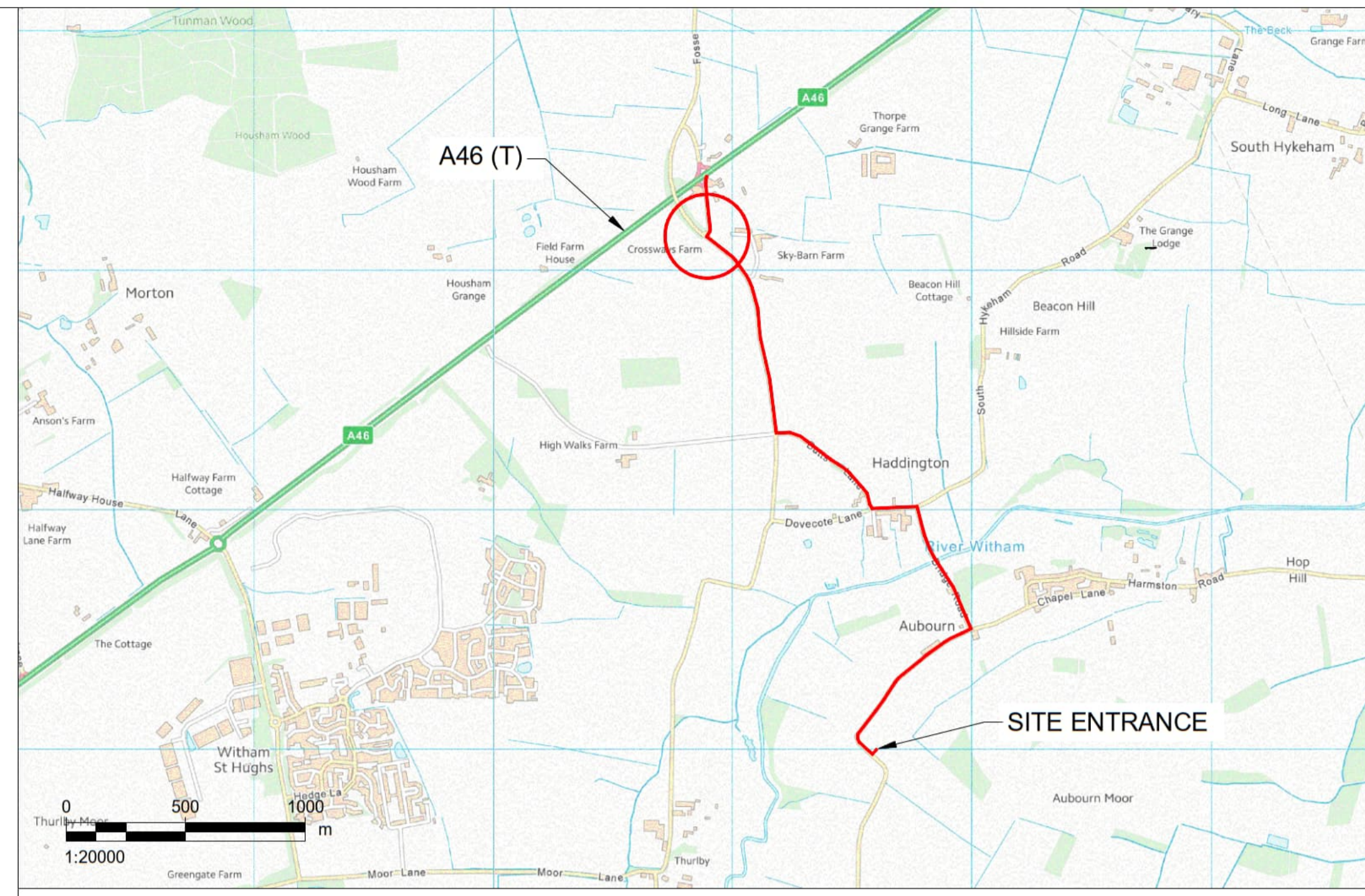
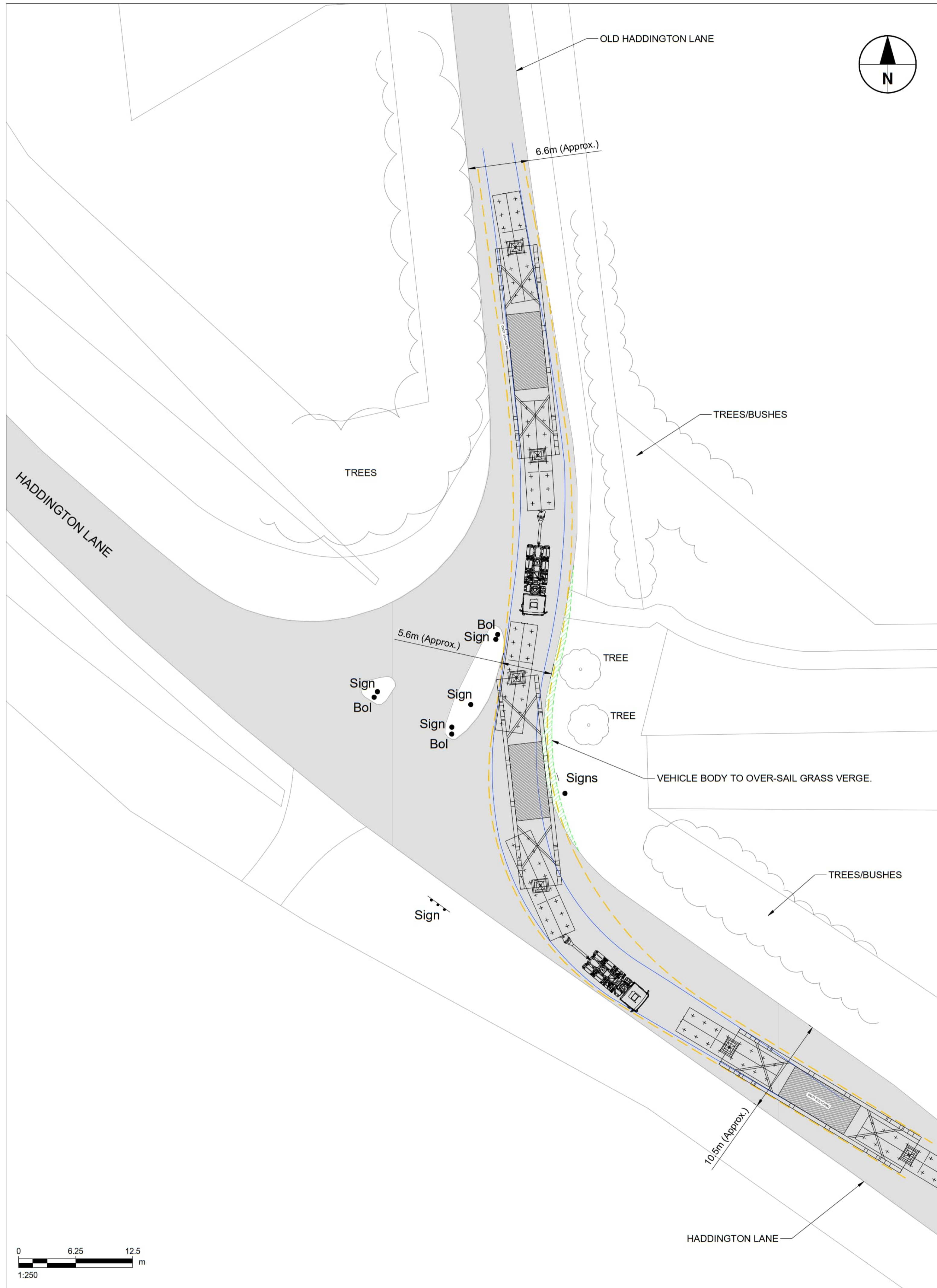

**NOTES:**

1. VEHICLE TRACKING SHOWN IS INDICATIVE ONLY, AND REPRESENTS APPROXIMATE VEHICLE SIZE / ARRANGEMENT ANTICIPATED FOR TRANSFORMER DELIVERY. SPECIFIC VEHICLE SIZE / ARRANGEMENT TO BE DETERMINED BY EQUIPMENT SUPPLIER AND HEAVY HAULAGE CONTRACTOR.
2. DEFINITIVE VEHICLE TRACKING OF SPECIFIC DELIVERY VEHICLE REQUIRES TO BE CARRIED OUT BY THE HEAVY HAULAGE CONTRACTOR, TO ENSURE THE DESIRED MANOEUVRES ARE ACHIEVABLE, AND TO CONFIRM ANY REQUIRED ROAD WIDENING, TEMPORARY WORKS, etc.
3. THIS DRAWING IS BASED ON ORDNANCE SURVEY MAPPING, AND AS SUCH IS INDICATIVE ONLY. ALL LINWORK, DIMENSIONS, STREET FURNITURE, etc. ARE APPROXIMATE ONLY.
4. THIS DRAWING IS BASED ON THE ASSUMED AIL ROUTE TO SITE. FINAL ROUTE TO BE DETERMINED BY THE HEAVY HAULAGE CONTRACTOR.

- Notes**
1. ALL DIMENSIONS IN METRES UNLESS STATED OTHERWISE.
  2. FOR OVERVIEW OF PROPOSED ABNORMAL LOAD ROUTE, REFER DRAWING 60700987-ACM-XX-00-DR-CE-1000.

- KEY**
- PROPOSED AIL ROUTE TO SITE
  - EXISTING CARRIAGEWAY
  - APPROXIMATE VEHICLE WHEEL TRACK
  - APPROXIMATE OVER-SAIL OF VEHICLE BODY
  - APPROXIMATE EXTENT OF OVER-SAIL AREA (AREA REQUIRES TO BE CLEAR OF ANY ABOVE-GROUND FEATURES)

**ISSUE/REVISION**

Rev	Date	Description	Dm/Chk/Apr
-	12.12.23	FIRST ISSUE	EP/CGY/MW

**Suitability Status**

S2 - Suitable For Information

**Project Number**

60700987

**Sheet Title**

ABNORMAL LOAD ROUTE TO SITE  
 VEHICLE TRACKING LOCATION 02  
 OLD HADDINGTON LANE / HADDINGTON LANE

**Sheet Number**

60700987-ACM-XX-00-DR-CE-1002

Scale: 1:250 @ A1

Rev: .

This drawing has been prepared for the use of AECOM's client. It may not be used, modified, reproduced or relied upon by third parties, except as agreed by AECOM or as required by law. AECOM accepts no responsibility, and denies any liability, whatsoever, to any party that uses or relies on this drawing without AECOM's express written consent. Do not scale this document. All measurements must be obtained from the stated dimensions.

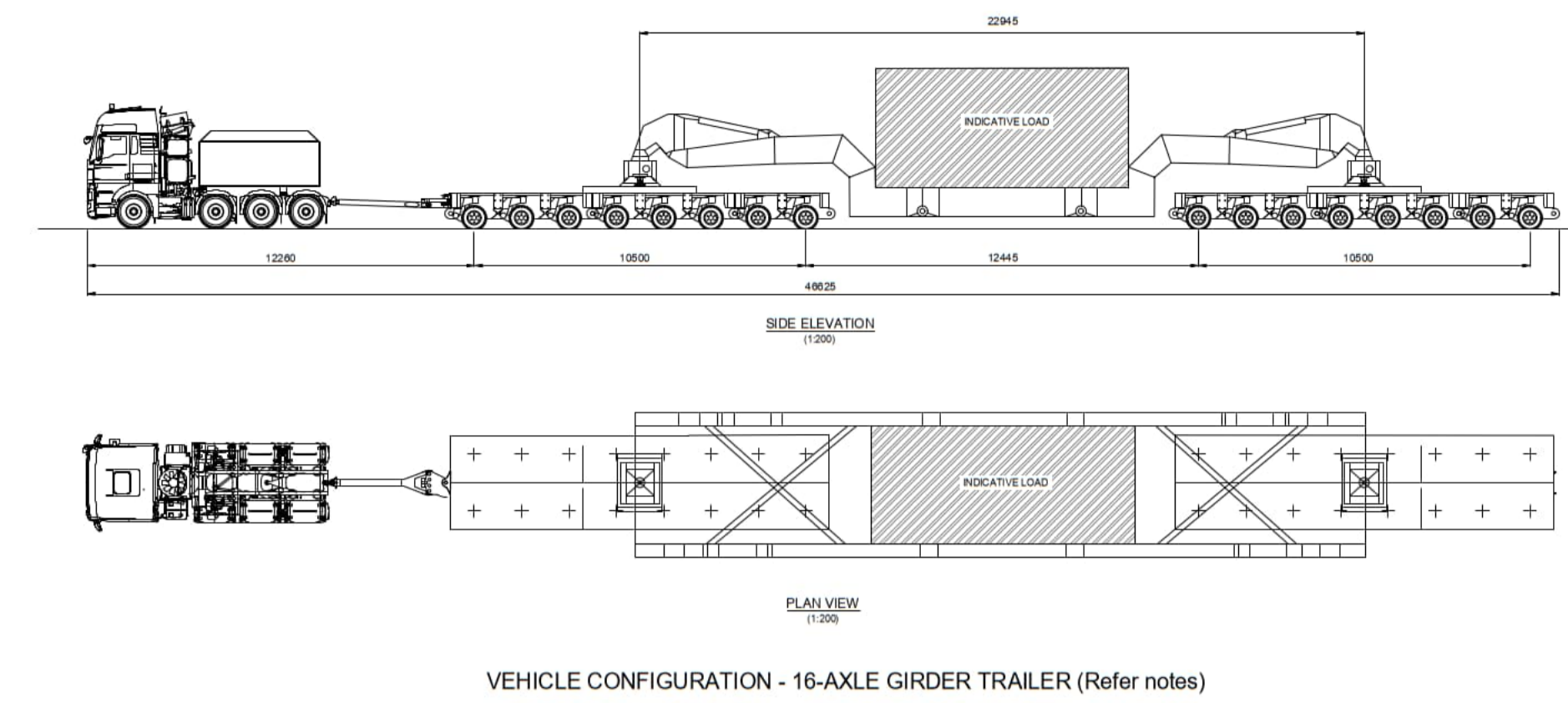
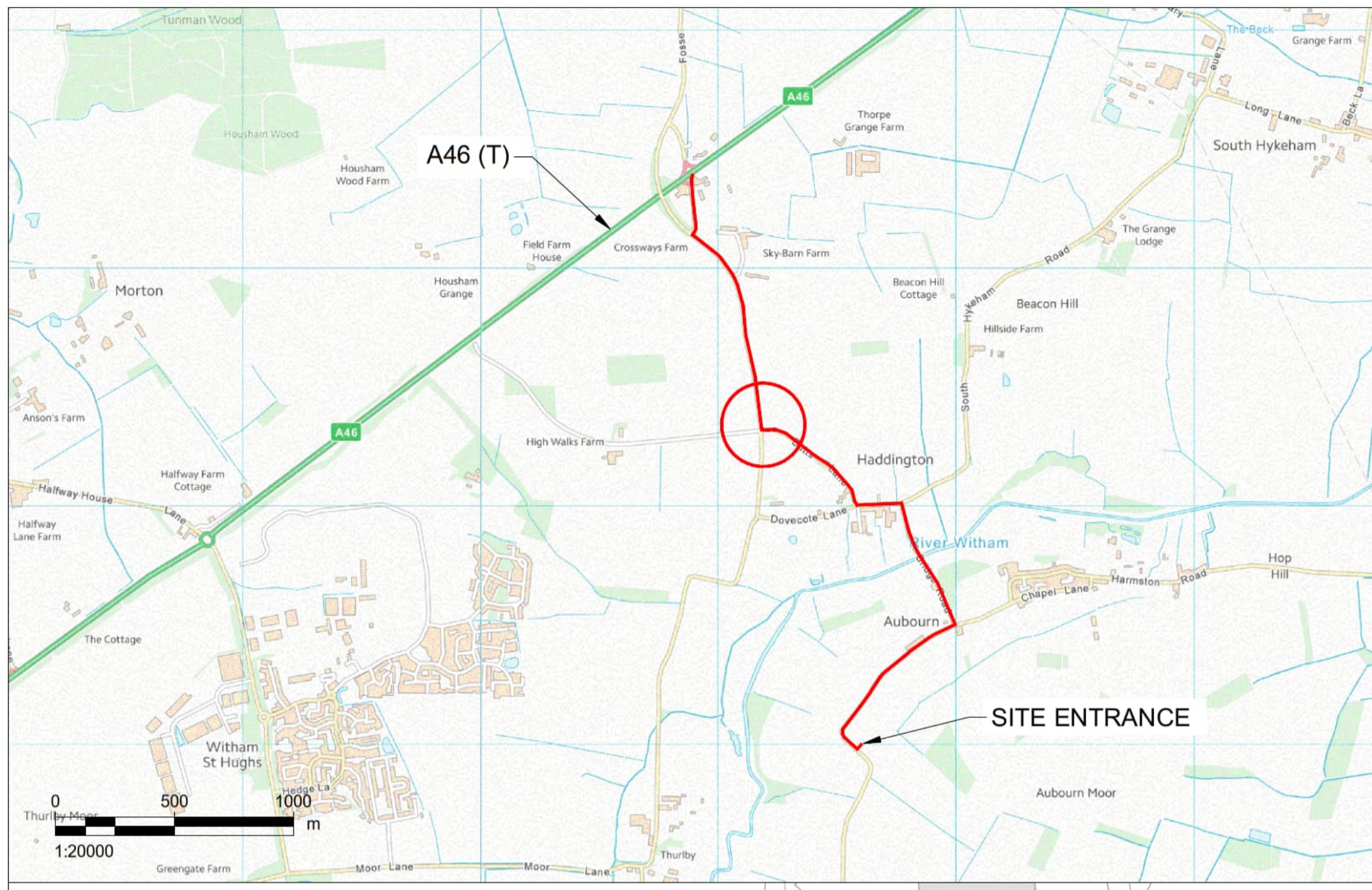

VEHICLE CONFIGURATION - 16-AXLE GIRDER TRAILER (Refer notes)

- NOTES:**
1. VEHICLE TRACKING SHOWN IS INDICATIVE ONLY, AND REPRESENTS APPROXIMATE VEHICLE SIZE / ARRANGEMENT ANTICIPATED FOR TRANSFORMER DELIVERY. SPECIFIC VEHICLE SIZE / ARRANGEMENT TO BE DETERMINED BY EQUIPMENT SUPPLIER AND HEAVY HAULAGE CONTRACTOR.
  2. DEFINITIVE VEHICLE TRACKING OF SPECIFIC DELIVERY VEHICLE REQUIRES TO BE CARRIED OUT BY THE HEAVY HAULAGE CONTRACTOR, TO ENSURE THE DESIRED MANOEUVRES ARE ACHIEVABLE, AND TO CONFIRM ANY REQUIRED ROAD WIDENING, TEMPORARY WORKS, etc.
  3. THIS DRAWING IS BASED ON ORDNANCE SURVEY MAPPING, AND AS SUCH IS INDICATIVE ONLY. ALL LINWORK, DIMENSIONS, STREET FURNITURE, etc. ARE APPROXIMATE ONLY.
  4. THIS DRAWING IS BASED ON THE ASSUMED AIR ROUTE TO SITE. FINAL ROUTE TO BE DETERMINED BY THE HEAVY HAULAGE CONTRACTOR.

- Notes**
1. ALL DIMENSIONS IN METRES UNLESS STATED OTHERWISE.
  2. FOR OVERVIEW OF PROPOSED ABNORMAL LOAD ROUTE, REFER DRAWING 60700987-ACM-XX-00-DR-CE-1000.

- KEY**
- PROPOSED AIR ROUTE TO SITE
  - EXISTING CARRIAGEWAY
  - APPROXIMATE VEHICLE WHEEL TRACK
  - APPROXIMATE OVER-SAIL OF VEHICLE BODY
  - APPROXIMATE EXTENT OF OVER-SAIL AREA (AREA REQUIRES TO BE CLEAR OF ANY ABOVE-GROUND FEATURES)

**ISSUE/REVISION**

Rev	Date	Description	Dm/Chk/Appr
-	12.12.23	FIRST ISSUE	EP/CGY/MW

**Suitability Status**  
 S2 - Suitable For Information

**Project Number**  
 60700987

**Sheet Title**  
 ABNORMAL LOAD ROUTE TO SITE  
 VEHICLE TRACKING LOCATION 03  
 HADDINGTON LANE / BUTTS LANE

**Sheet Number**  
 60700987-ACM-XX-00-DR-CE-1003

**Scale:** 1:250 @ A1 **Rev:** .

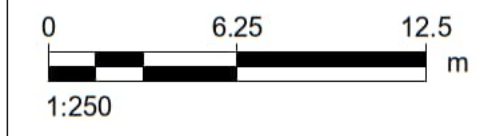
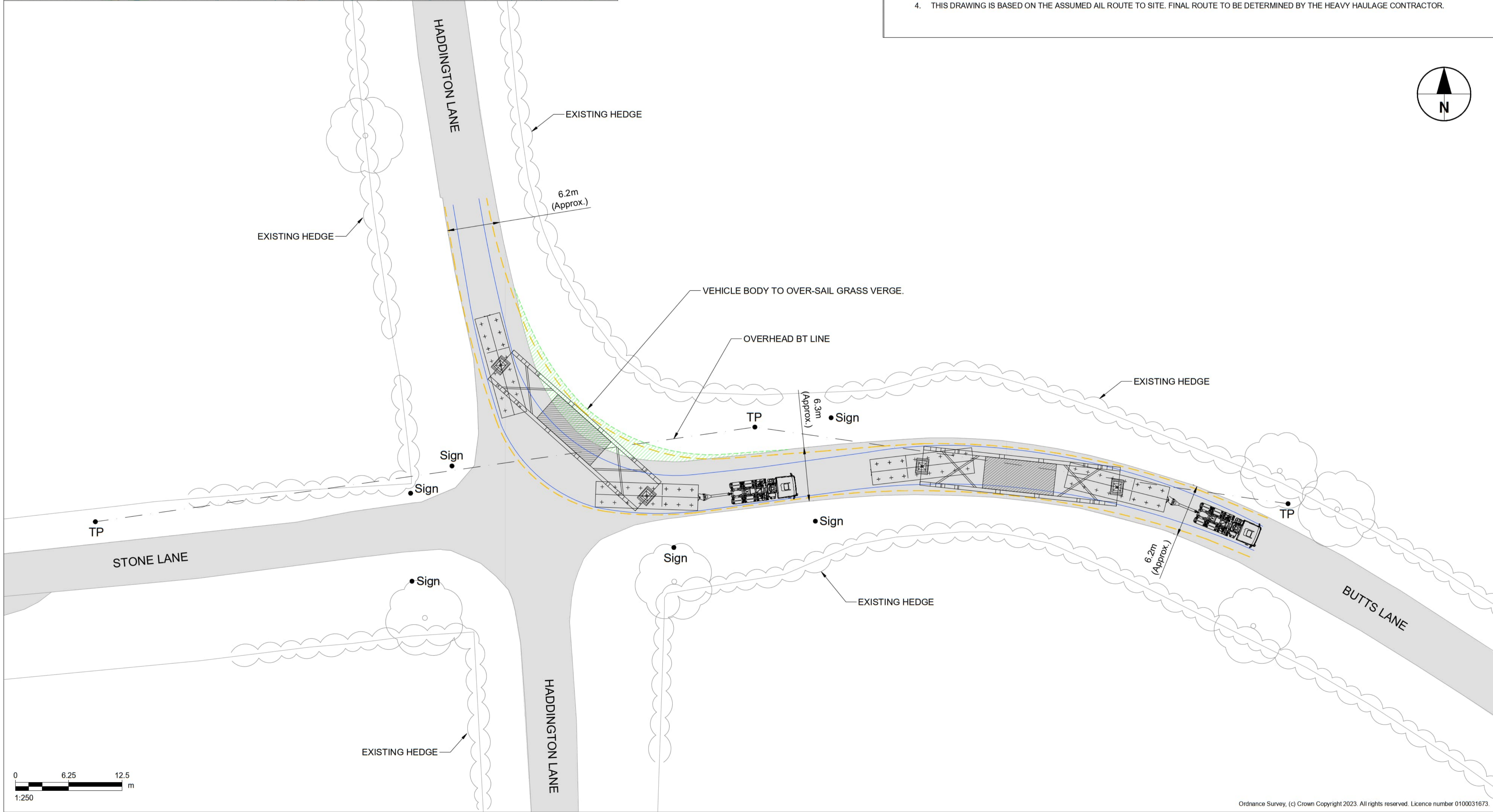

This drawing has been prepared for the use of AECOM's client. It may not be used, modified, reproduced or relied upon by third parties, except as agreed by AECOM or as required by law. AECOM accepts no responsibility, and denies any liability, whatsoever, to any party that uses or relies on this drawing without AECOM's express written consent. All measurements must be obtained from the stated dimensions.

- Notes**
- ALL DIMENSIONS IN METRES UNLESS STATED OTHERWISE.
  - FOR OVERVIEW OF PROPOSED ABNORMAL LOAD ROUTE, REFER DRAWING 60700987-ACM-XX-00-DR-CE-1000.

- KEY**
- PROPOSED AIL ROUTE TO SITE
  - EXISTING CARRIAGEWAY
  - APPROXIMATE VEHICLE WHEEL TRACK
  - APPROXIMATE OVER-SAIL OF VEHICLE BODY
  - APPROXIMATE EXTENT OF OVER-SAIL AREA (AREA REQUIRES TO BE CLEAR OF ANY ABOVE-GROUND FEATURES)

**ISSUE/REVISION**

Rev	Date	Description	Dm/Chk/Appr
-	12.12.23	FIRST ISSUE	EP/CGY/MW

**Suitability Status**

S2 - Suitable For Information

**Project Number**

60700987

**Sheet Title**

ABNORMAL LOAD ROUTE TO SITE  
 VEHICLE TRACKING LOCATION 04  
 BUTTS LANE

**Sheet Number**

60700987-ACM-XX-00-DR-CE-1004

Scale: 1:250 @ A1

Rev: .

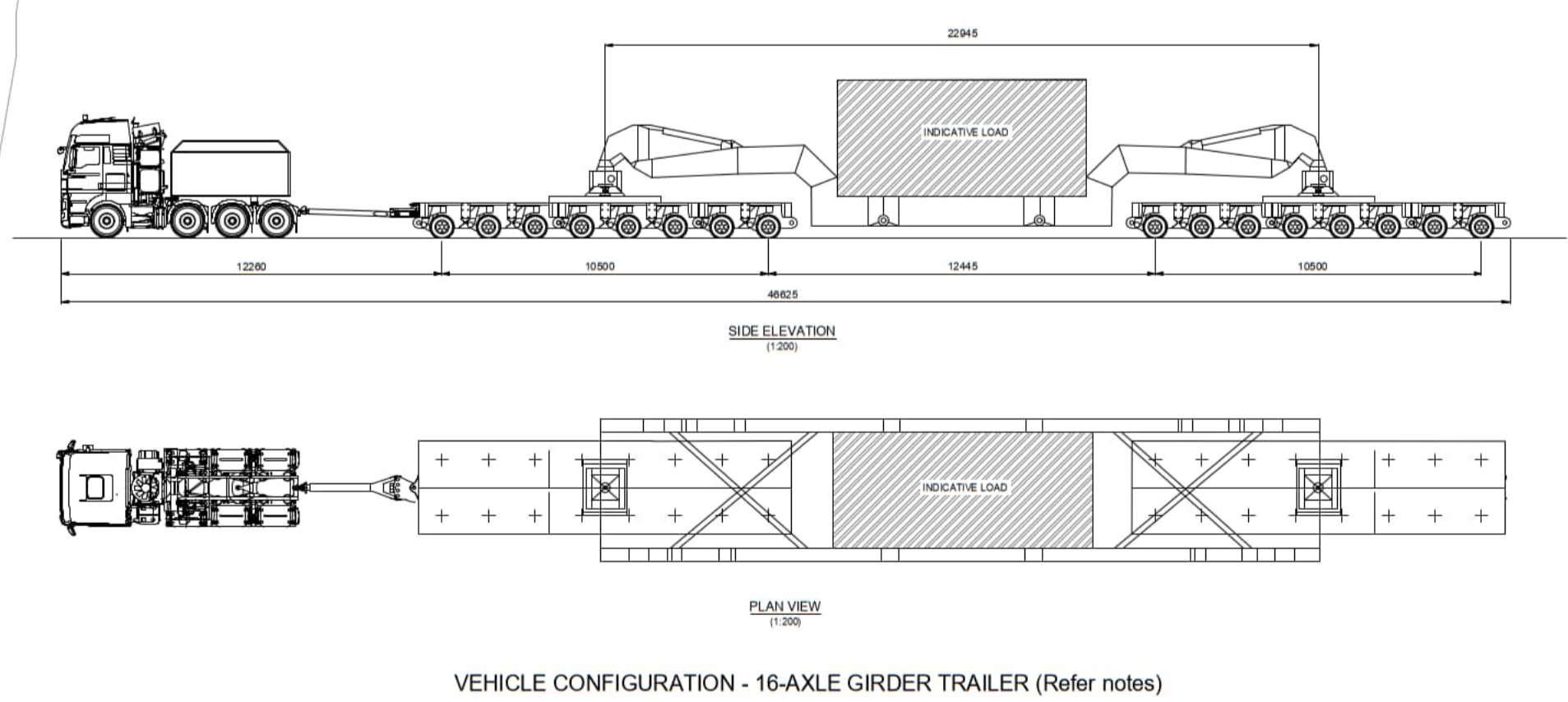
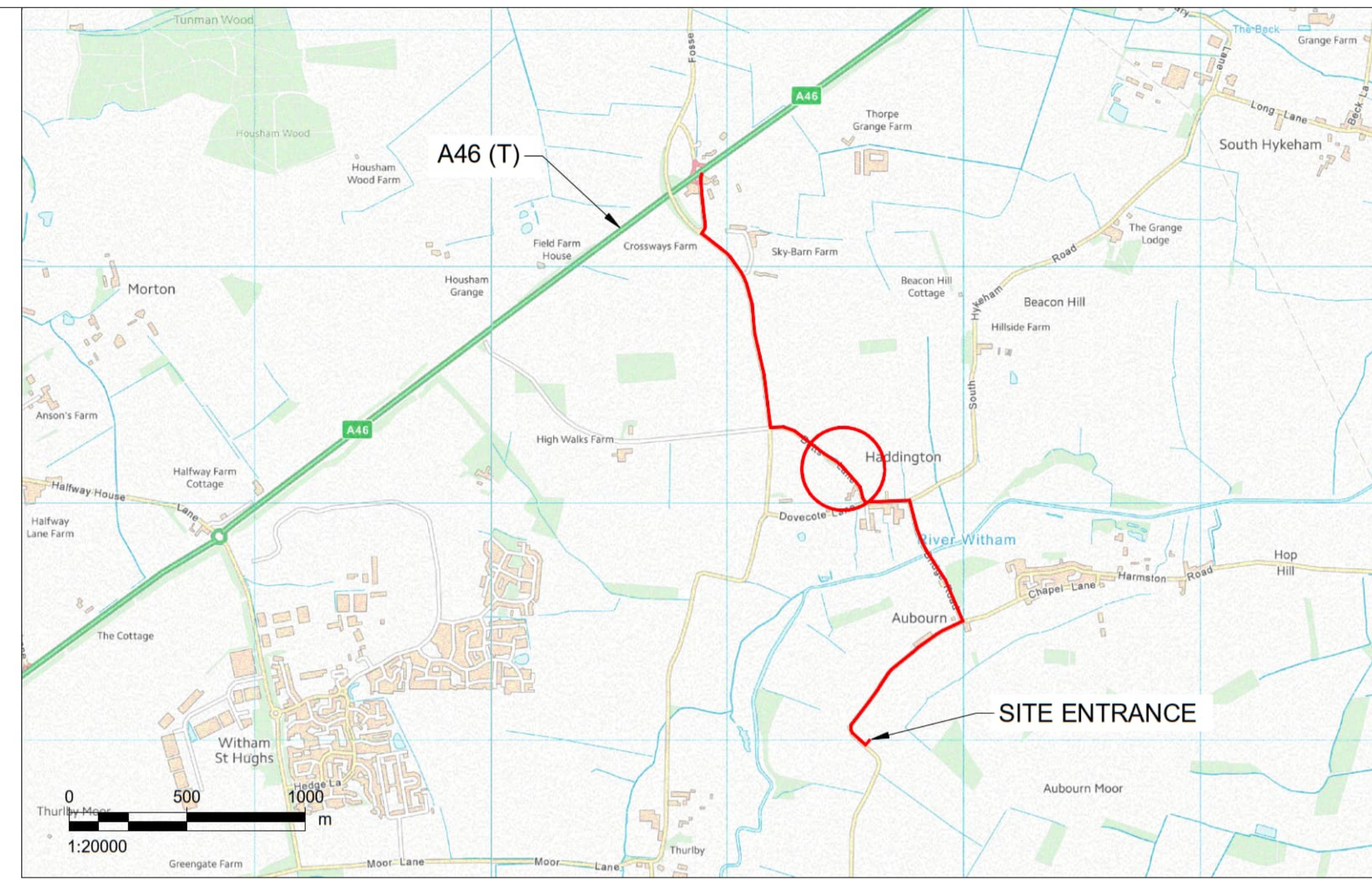
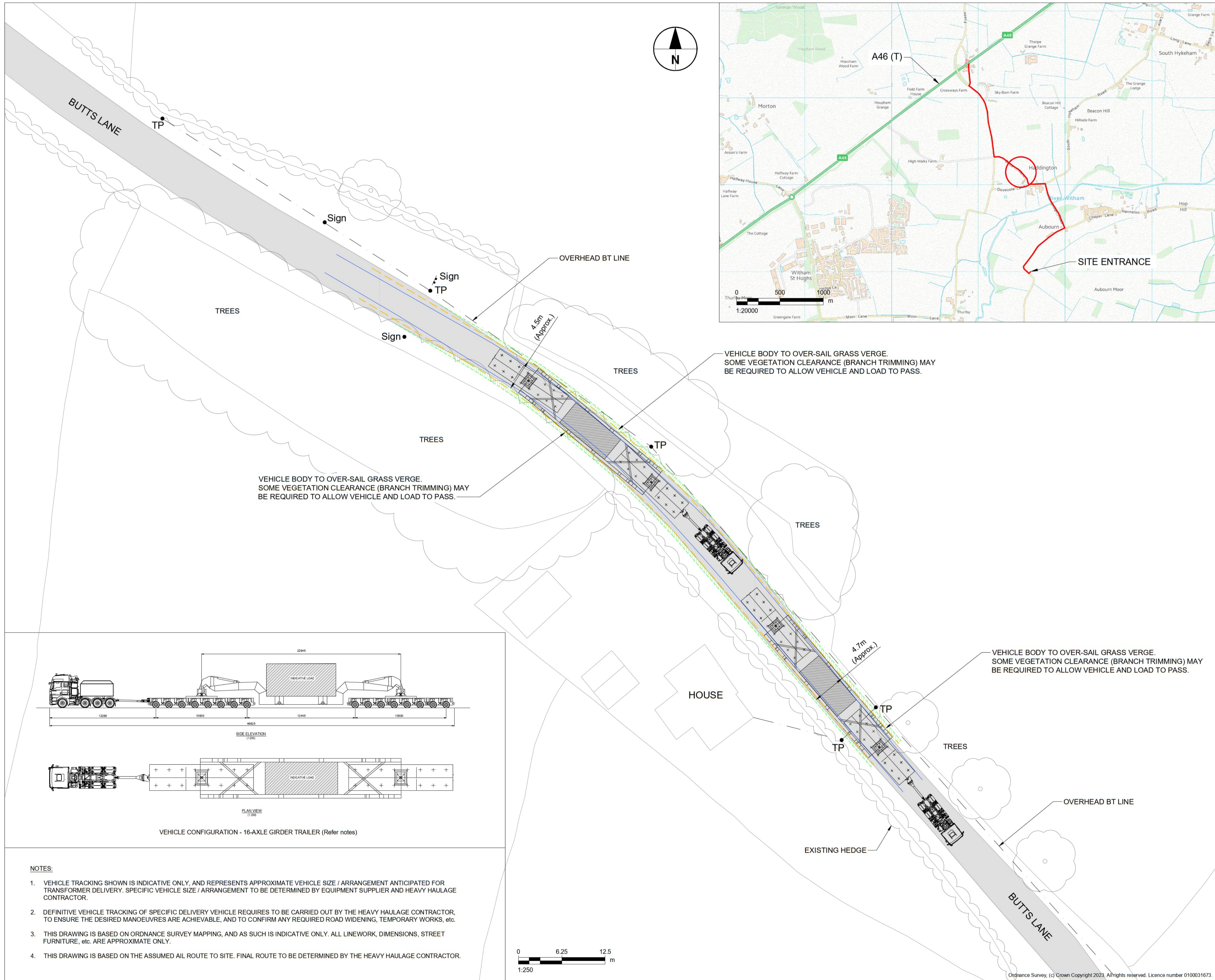

VEHICLE CONFIGURATION - 16-AXLE GIRDER TRAILER (Refer notes)

- NOTES:**
- VEHICLE TRACKING SHOWN IS INDICATIVE ONLY, AND REPRESENTS APPROXIMATE VEHICLE SIZE / ARRANGEMENT ANTICIPATED FOR TRANSFORMER DELIVERY. SPECIFIC VEHICLE SIZE / ARRANGEMENT TO BE DETERMINED BY EQUIPMENT SUPPLIER AND HEAVY HAULAGE CONTRACTOR.
  - DEFINITIVE VEHICLE TRACKING OF SPECIFIC DELIVERY VEHICLE REQUIRES TO BE CARRIED OUT BY THE HEAVY HAULAGE CONTRACTOR, TO ENSURE THE DESIRED MANOEUVRES ARE ACHIEVABLE, AND TO CONFIRM ANY REQUIRED ROAD WIDENING, TEMPORARY WORKS, etc.
  - THIS DRAWING IS BASED ON ORDNANCE SURVEY MAPPING, AND AS SUCH IS INDICATIVE ONLY. ALL LINWORK, DIMENSIONS, STREET FURNITURE, etc. ARE APPROXIMATE ONLY.
  - THIS DRAWING IS BASED ON THE ASSUMED AIL ROUTE TO SITE. FINAL ROUTE TO BE DETERMINED BY THE HEAVY HAULAGE CONTRACTOR.

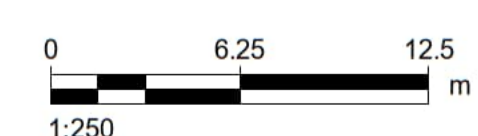

This drawing has been prepared for the use of AECOM's client. It may not be used, modified, reproduced or relied upon by third parties, except as agreed by AECOM, and AECOM accepts no responsibility, and denies any liability, whatsoever, to any party that uses or relies on this drawing without AECOM's express written consent. All measurements must be obtained from the stated dimensions.

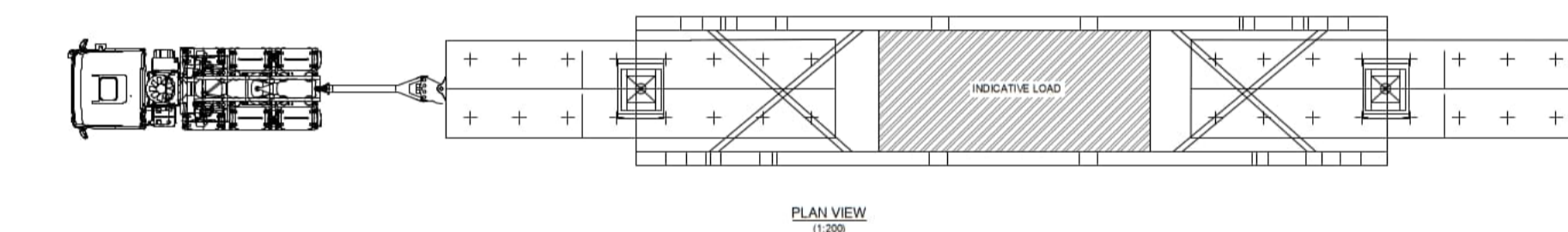
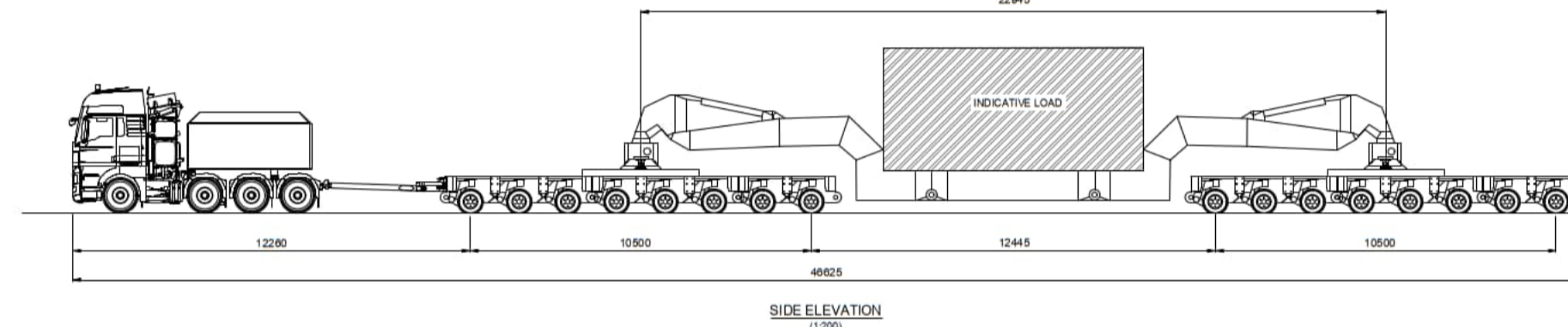
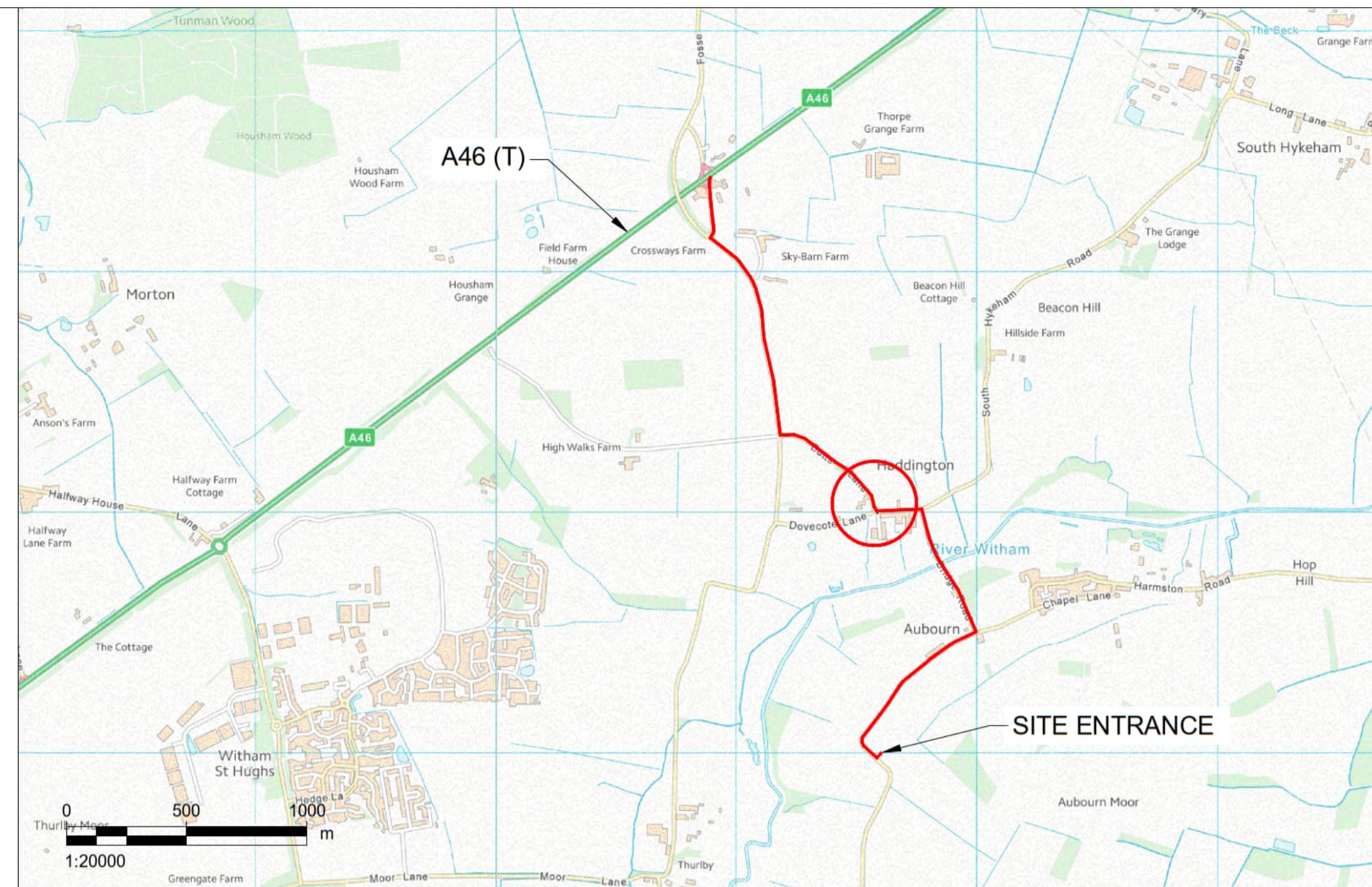
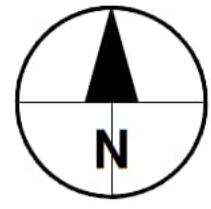
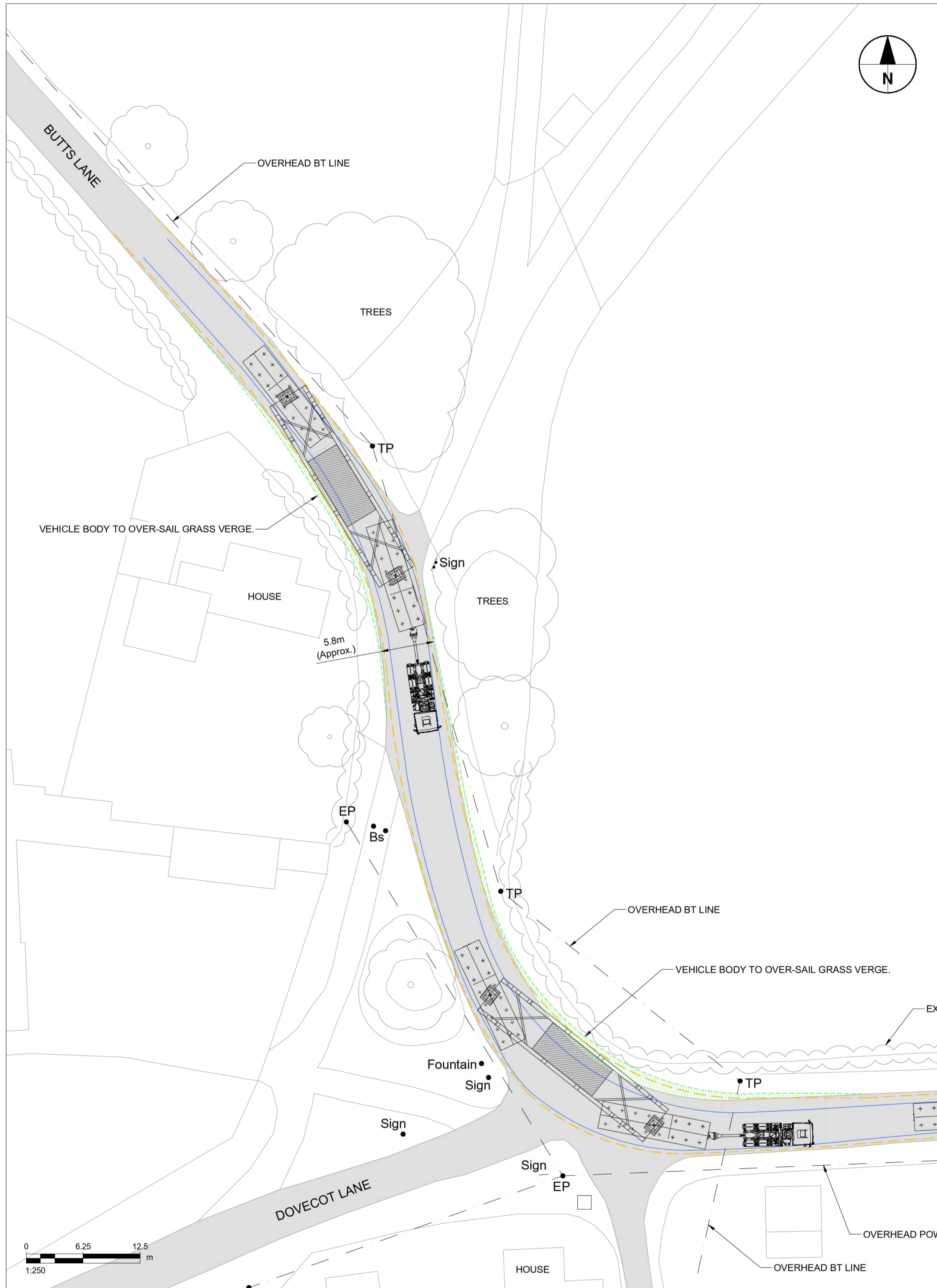

VEHICLE CONFIGURATION - 16-AXLE GIRDER TRAILER (Refer notes)

**NOTES:**

1. VEHICLE TRACKING SHOWN IS INDICATIVE ONLY, AND REPRESENTS APPROXIMATE VEHICLE SIZE / ARRANGEMENT ANTICIPATED FOR TRANSFORMER DELIVERY. SPECIFIC VEHICLE SIZE / ARRANGEMENT TO BE DETERMINED BY EQUIPMENT SUPPLIER AND HEAVY HAULAGE CONTRACTOR.
2. DEFINITIVE VEHICLE TRACKING OF SPECIFIC DELIVERY VEHICLE REQUIRES TO BE CARRIED OUT BY THE HEAVY HAULAGE CONTRACTOR, TO ENSURE THE DESIRED MANOEUVRES ARE ACHIEVABLE, AND TO CONFIRM ANY REQUIRED ROAD WIDENING, TEMPORARY WORKS, etc.
3. THIS DRAWING IS BASED ON ORDNANCE SURVEY MAPPING, AND AS SUCH IS INDICATIVE ONLY. ALL LINWORK, DIMENSIONS, STREET FURNITURE, etc. ARE APPROXIMATE ONLY.
4. THIS DRAWING IS BASED ON THE ASSUMED AIL ROUTE TO SITE. FINAL ROUTE TO BE DETERMINED BY THE HEAVY HAULAGE CONTRACTOR.

- Notes**
1. ALL DIMENSIONS IN METRES UNLESS STATED OTHERWISE.
  2. FOR OVERVIEW OF PROPOSED ABNORMAL LOAD ROUTE, REFER DRAWING 60700987-ACM-XX-00-DR-CE-1000.

- KEY**
- PROPOSED AIL ROUTE TO SITE
  - ▭ EXISTING CARRIAGEWAY
  - APPROXIMATE VEHICLE WHEEL TRACK
  - - - APPROXIMATE OVER-SAIL OF VEHICLE BODY
  - ▨ APPROXIMATE EXTENT OF OVER-SAIL AREA (AREA REQUIRES TO BE CLEAR OF ANY ABOVE-GROUND FEATURES)

**ISSUE/REVISION**

Rev	Date	Description	Dm/Chk/Apr
-	12.12.23	FIRST ISSUE	EP/CGY/MW

**Suitability Status**

S2 - Suitable For Information

**Project Number**

60700987

**Sheet Title**

ABNORMAL LOAD ROUTE TO SITE  
 VEHICLE TRACKING LOCATION 05  
 BUTTS LANE / SOUTH HYKEHAM ROAD

**Sheet Number**

60700987-ACM-XX-00-DR-CE-1005

Scale: 1:250 @ A1 Rev: -

ISSUE/REVISION			
Rev	Date	Description	EP/CGY/MW Dm/Chk/Apr
-	12.12.23	FIRST ISSUE	EP/CGY/MW

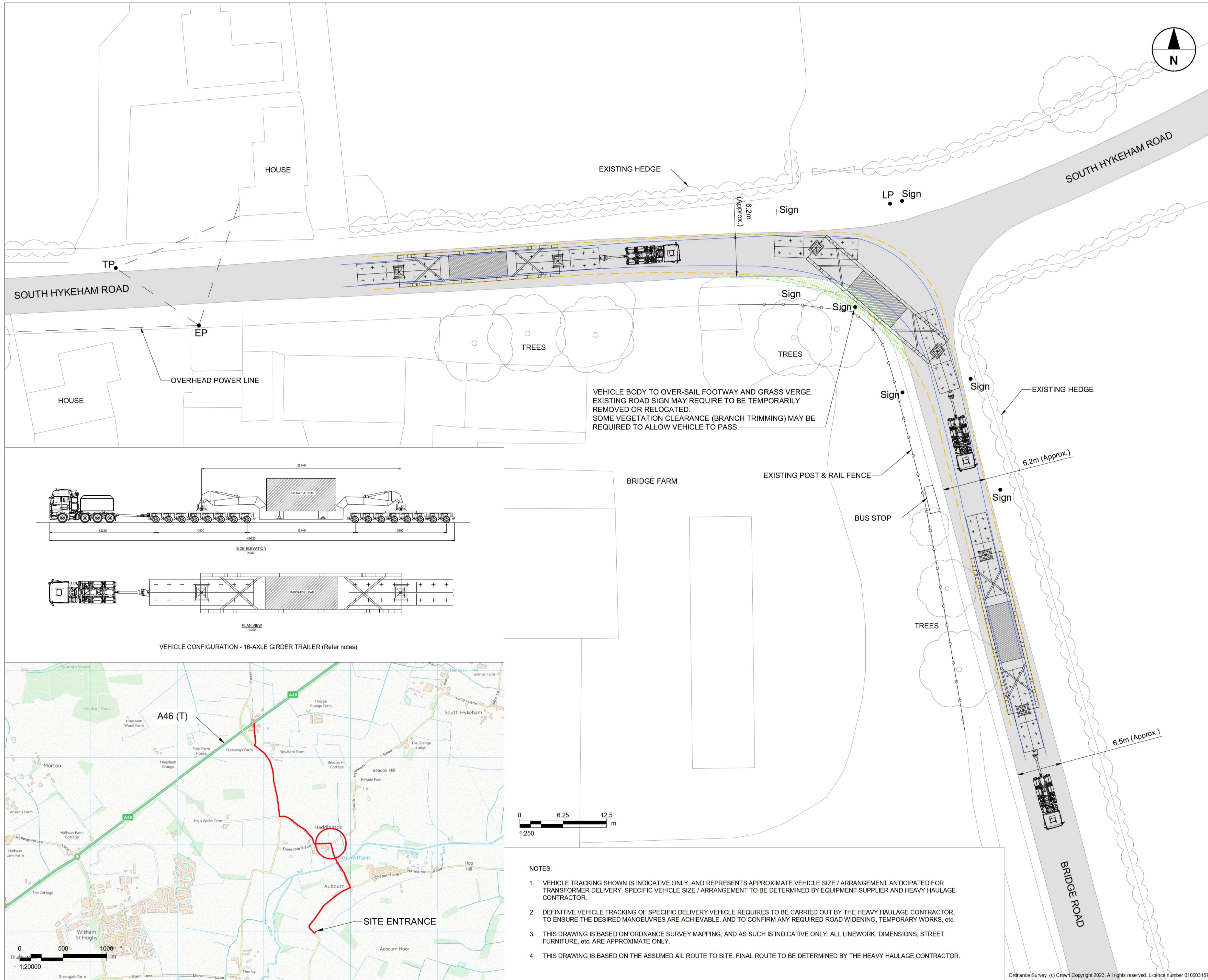

VEHICLE BODY TO OVER-SAIL FOOTWAY AND GRASS VERGE. EXISTING ROAD SIGN MAY REQUIRE TO BE TEMPORARILY REMOVED OR RELOCATED. SOME VEGETATION CLEARANCE (BRANCH TRIMMING) MAY BE REQUIRED TO ALLOW VEHICLE TO PASS.

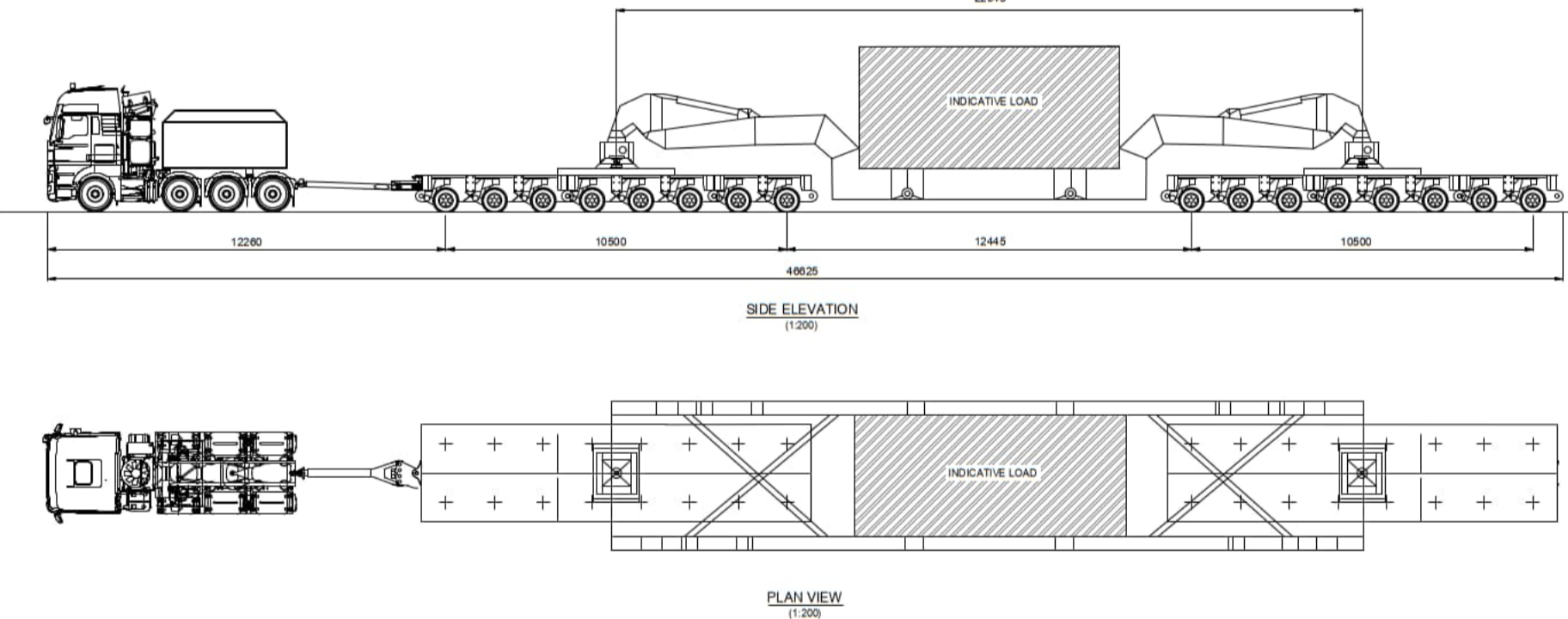

VEHICLE CONFIGURATION - 16-AXLE GIRDER TRAILER (Refer notes)

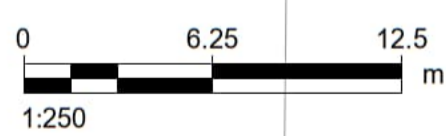
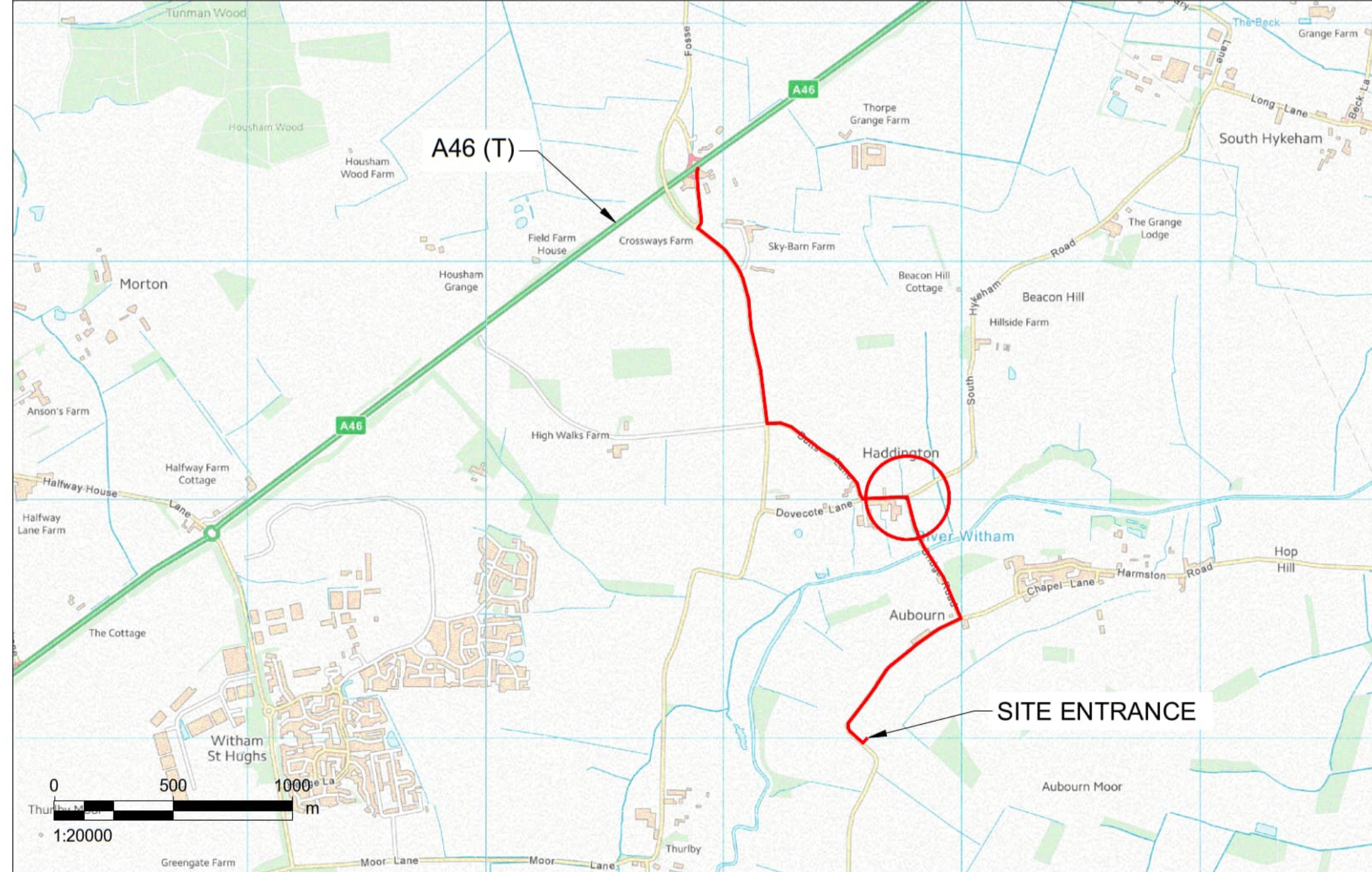

- NOTES:**
- VEHICLE TRACKING SHOWN IS INDICATIVE ONLY, AND REPRESENTS APPROXIMATE VEHICLE SIZE / ARRANGEMENT ANTICIPATED FOR TRANSFORMER DELIVERY. SPECIFIC VEHICLE SIZE / ARRANGEMENT TO BE DETERMINED BY EQUIPMENT SUPPLIER AND HEAVY HAULAGE CONTRACTOR.
  - DEFINITIVE VEHICLE TRACKING OF SPECIFIC DELIVERY VEHICLE REQUIRES TO BE CARRIED OUT BY THE HEAVY HAULAGE CONTRACTOR, TO ENSURE THE DESIRED MANOEUVRES ARE ACHIEVABLE, AND TO CONFIRM ANY REQUIRED ROAD WIDENING, TEMPORARY WORKS, etc.
  - THIS DRAWING IS BASED ON ORDNANCE SURVEY MAPPING, AND AS SUCH IS INDICATIVE ONLY. ALL LINWORK, DIMENSIONS, STREET FURNITURE, etc. ARE APPROXIMATE ONLY.
  - THIS DRAWING IS BASED ON THE ASSUMED AIL ROUTE TO SITE. FINAL ROUTE TO BE DETERMINED BY THE HEAVY HAULAGE CONTRACTOR.

This drawing has been prepared for the use of AECOM's client. It may not be used, modified, reproduced or relied upon by third parties, except as agreed by AECOM or as required by law. AECOM accepts no responsibility, and denies any liability, whatsoever, to any party that uses or relies on this drawing without AECOM's express written consent. Do not scale this document. All measurements must be obtained from the stated dimensions.

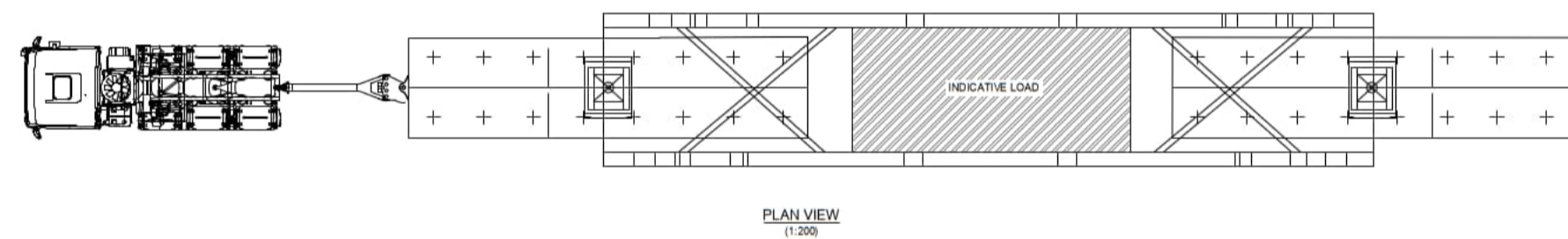
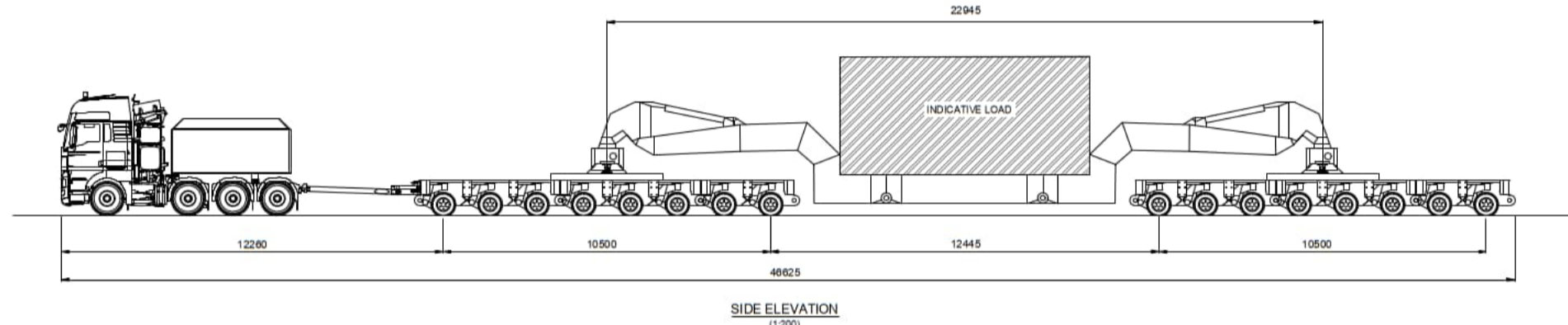
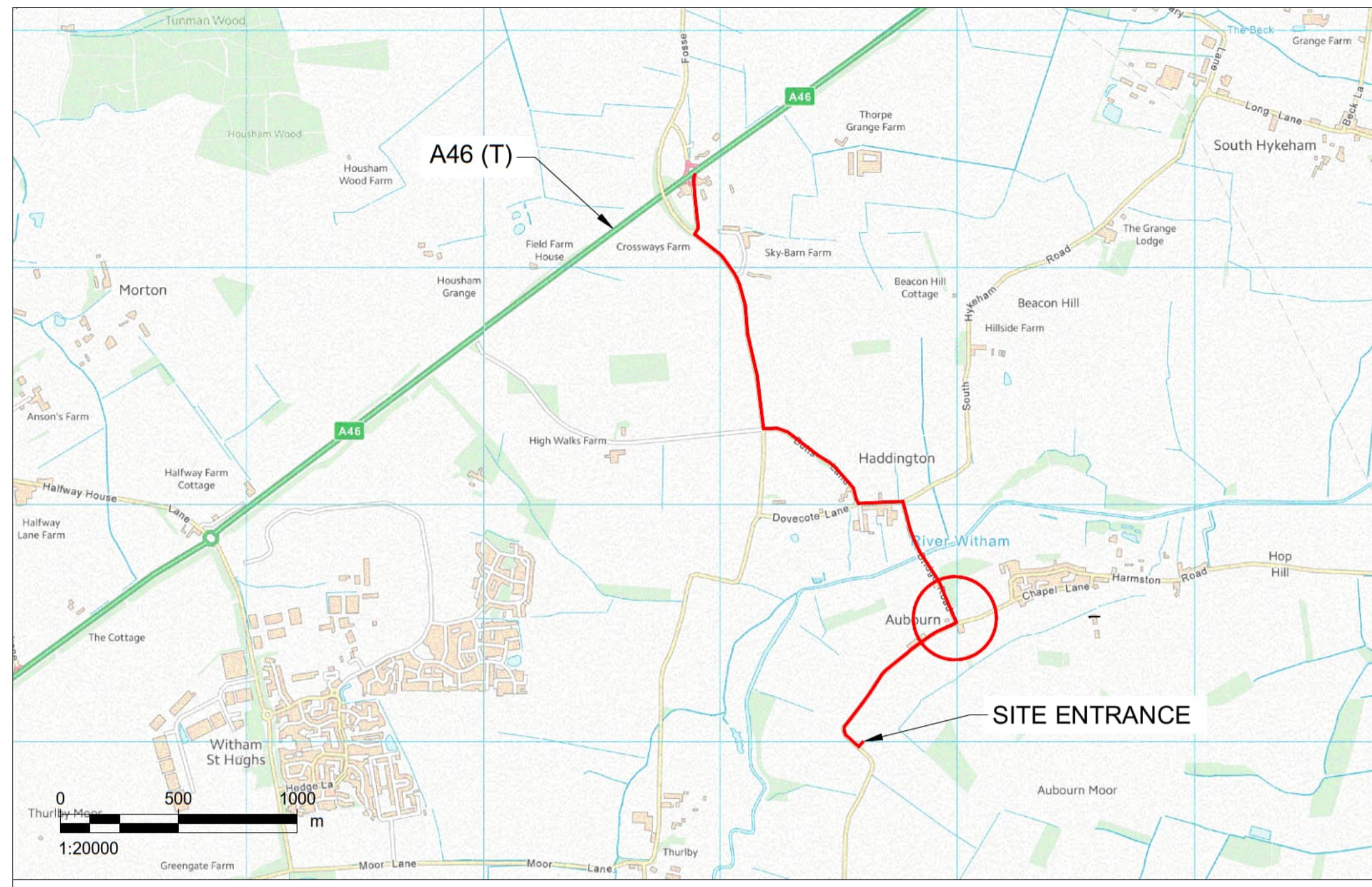

VEHICLE CONFIGURATION - 16-AXLE GIRDER TRAILER (Refer notes)

**NOTES:**

1. VEHICLE TRACKING SHOWN IS INDICATIVE ONLY, AND REPRESENTS APPROXIMATE VEHICLE SIZE / ARRANGEMENT ANTICIPATED FOR TRANSFORMER DELIVERY. SPECIFIC VEHICLE SIZE / ARRANGEMENT TO BE DETERMINED BY EQUIPMENT SUPPLIER AND HEAVY HAULAGE CONTRACTOR.
2. DEFINITIVE VEHICLE TRACKING OF SPECIFIC DELIVERY VEHICLE REQUIRES TO BE CARRIED OUT BY THE HEAVY HAULAGE CONTRACTOR, TO ENSURE THE DESIRED MANOEUVRES ARE ACHIEVABLE, AND TO CONFIRM ANY REQUIRED ROAD WIDENING, TEMPORARY WORKS, etc.
3. THIS DRAWING IS BASED ON ORDNANCE SURVEY MAPPING, AND AS SUCH IS INDICATIVE ONLY. ALL LINWORK, DIMENSIONS, STREET FURNITURE, etc. ARE APPROXIMATE ONLY.
4. THIS DRAWING IS BASED ON THE ASSUMED AIL ROUTE TO SITE. FINAL ROUTE TO BE DETERMINED BY THE HEAVY HAULAGE CONTRACTOR.

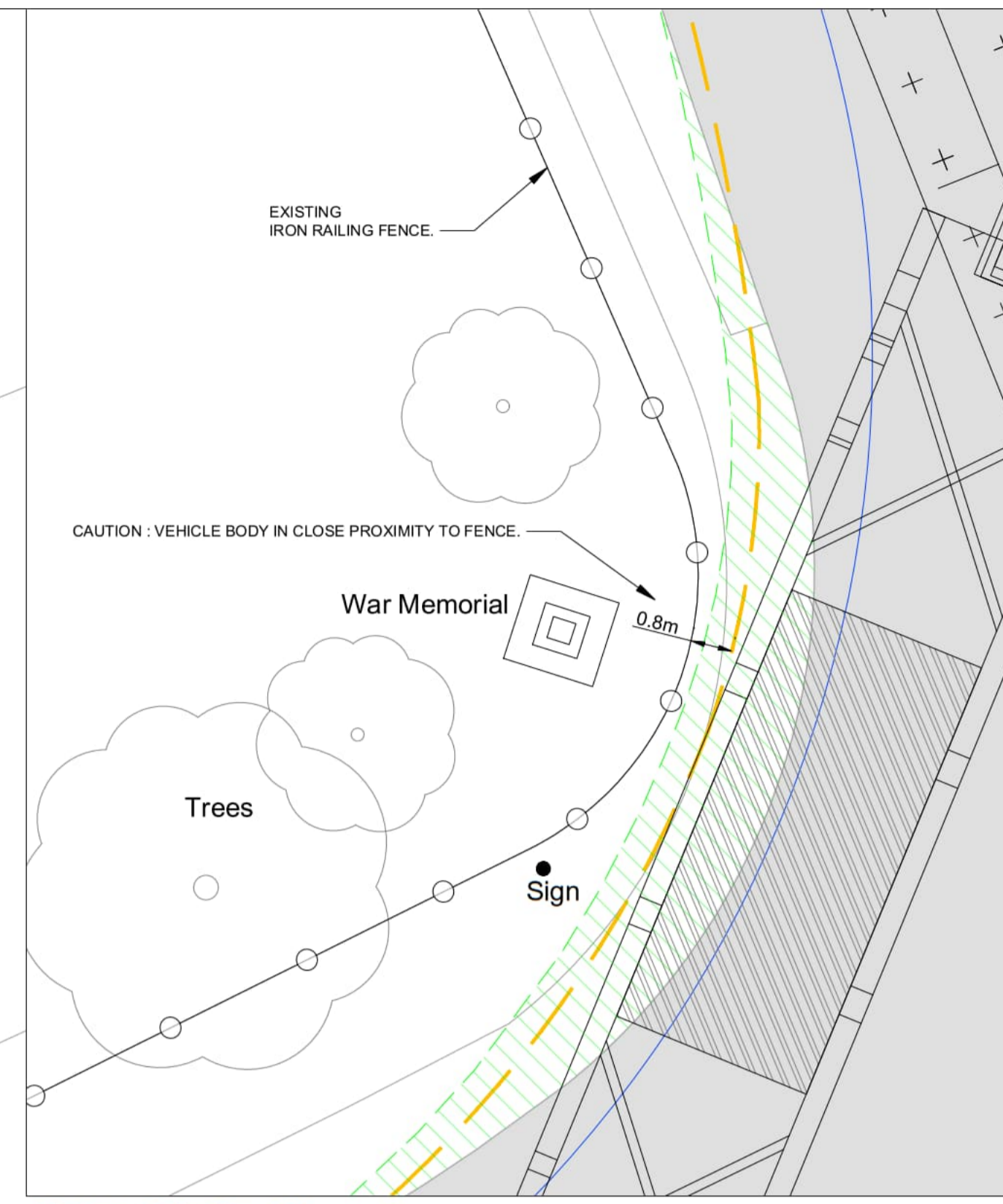
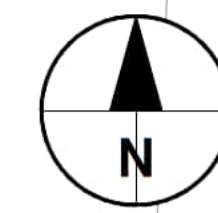
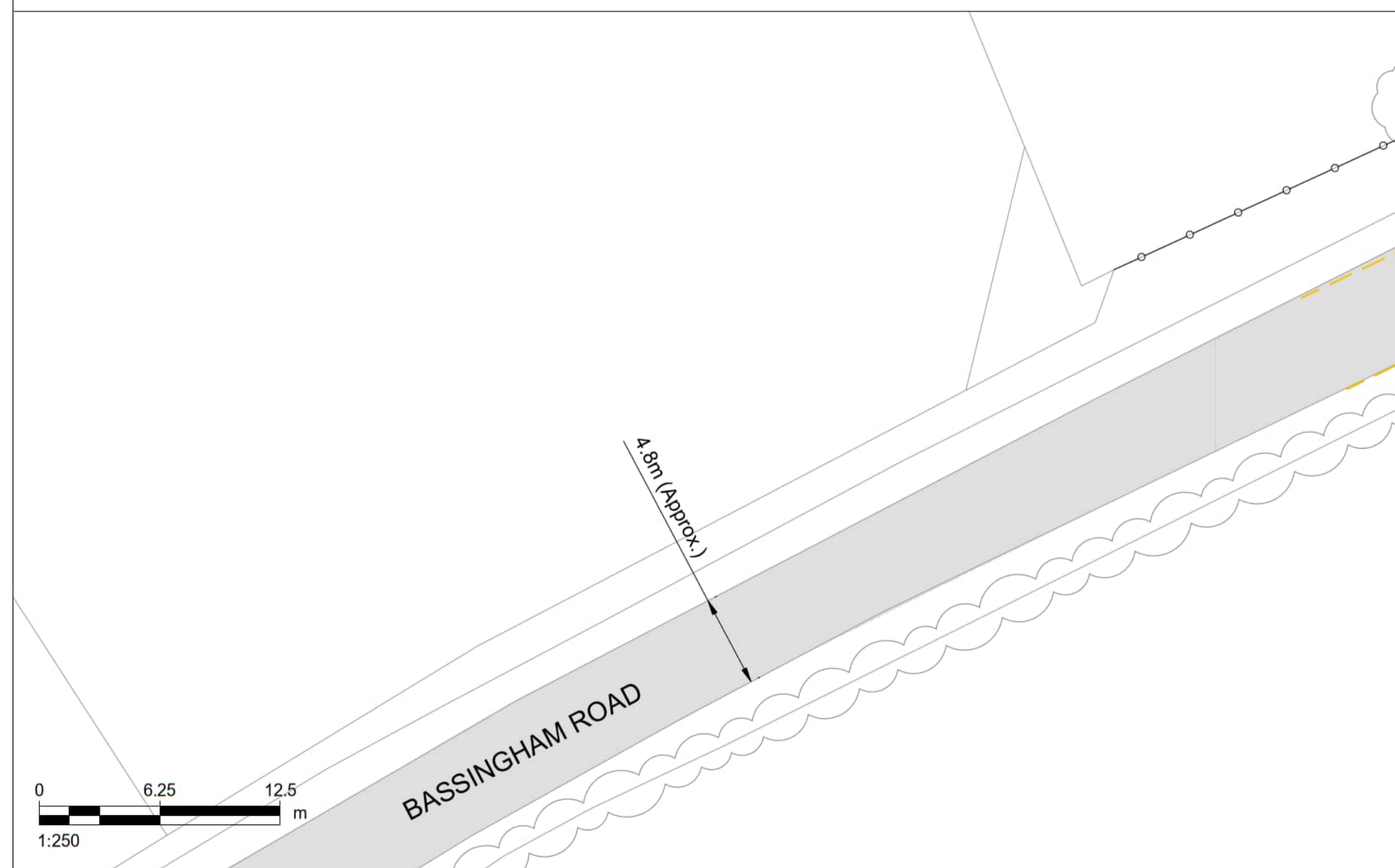

DETAIL (SCALE 1:100)

**Consultant**

**Aecom**  
 2 City Walk  
 Leeds  
 LS11 9AR  
 United Kingdom  
 Fax +44 (0)113 391 6899  
 Tel +44 (0)113 391 6800  
 www.aecom.com

**Notes**

1. ALL DIMENSIONS IN METRES UNLESS STATED OTHERWISE.
2. FOR OVERVIEW OF PROPOSED ABNORMAL LOAD ROUTE, REFER DRAWING 60700987-ACM-XX-00-DR-CE-1000.

**KEY**

- PROPOSED AIL ROUTE TO SITE
- EXISTING CARRIAGEWAY
- APPROXIMATE VEHICLE WHEEL TRACK
- APPROXIMATE OVER-SAIL OF VEHICLE BODY
- APPROXIMATE EXTENT OF OVER-SAIL AREA (AREA REQUIRES TO BE CLEAR OF ANY ABOVE-GROUND FEATURES)

**ISSUE/REVISION**

Rev	Date	Description	Dm/Chk/Apr
-	12.12.23	FIRST ISSUE	EP/CGY/MW

**Suitability Status**

S2 - Suitable For Information

**Project Number**

60700987

**Sheet Title**

ABNORMAL LOAD ROUTE TO SITE  
 VEHICLE TRACKING LOCATION 07  
 BRIDGE ROAD / BASSINGHAM ROAD

**Sheet Number**

60700987-ACM-XX-00-DR-CE-1007

Scale: 1:250 @ A1

Rev: .

This drawing has been prepared for the use of AECOM's client. It may not be used, modified, reproduced or relied upon by third parties, except as agreed by AECOM or as required by law. AECOM accepts no responsibility, and denies any liability, whatsoever, to any party that uses or relies on this drawing without AECOM's express written consent. All measurements must be obtained from the stated dimensions.

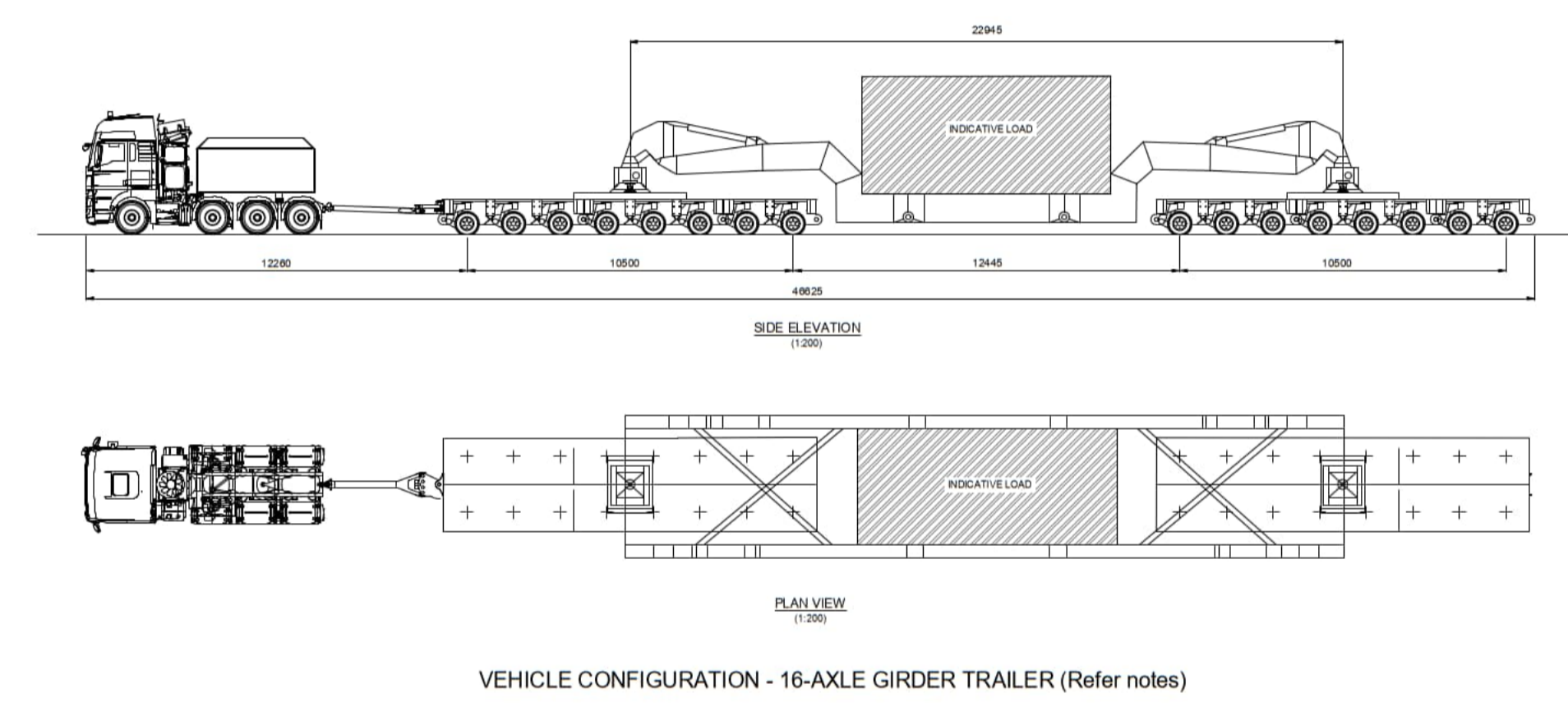
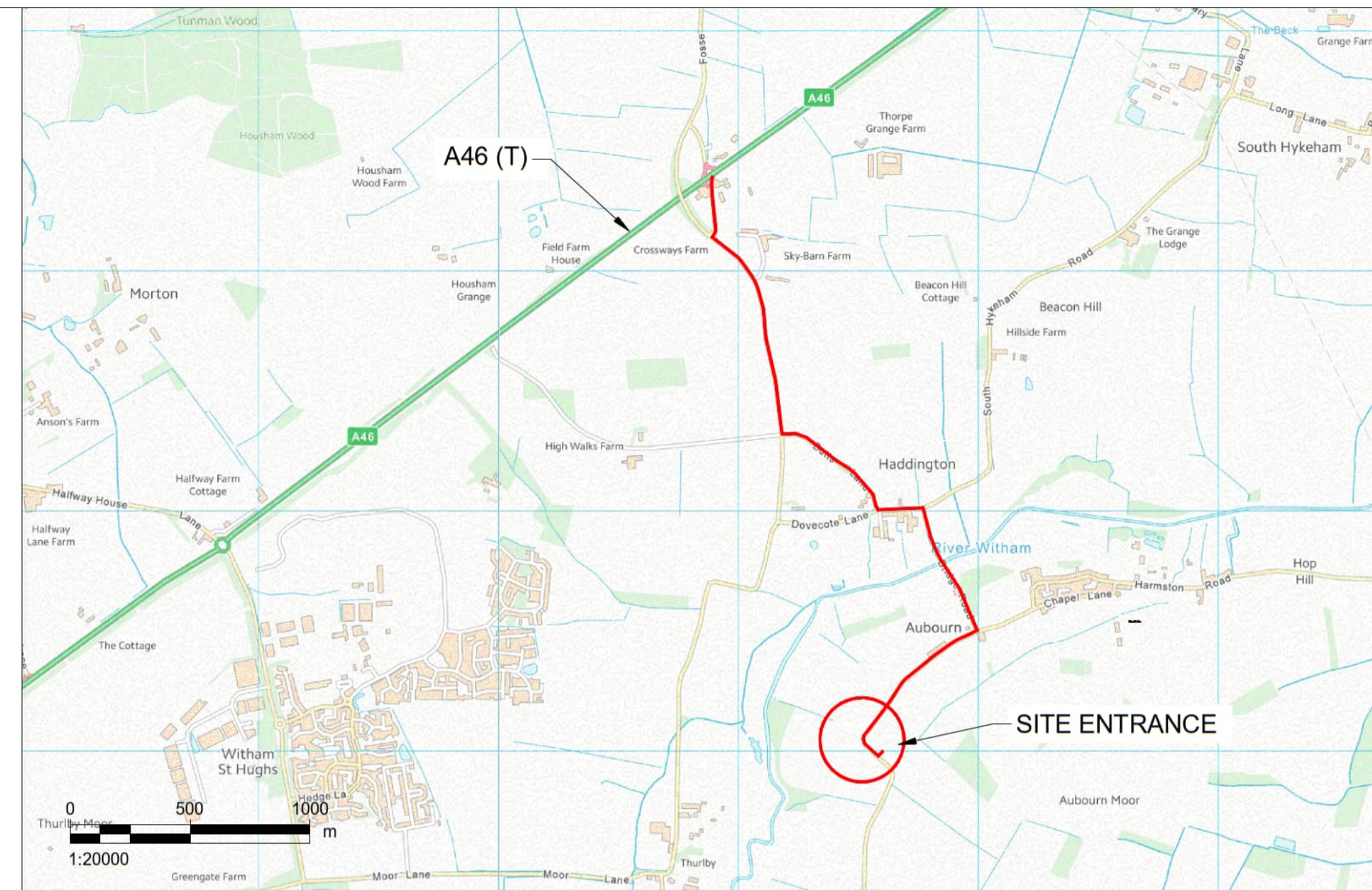
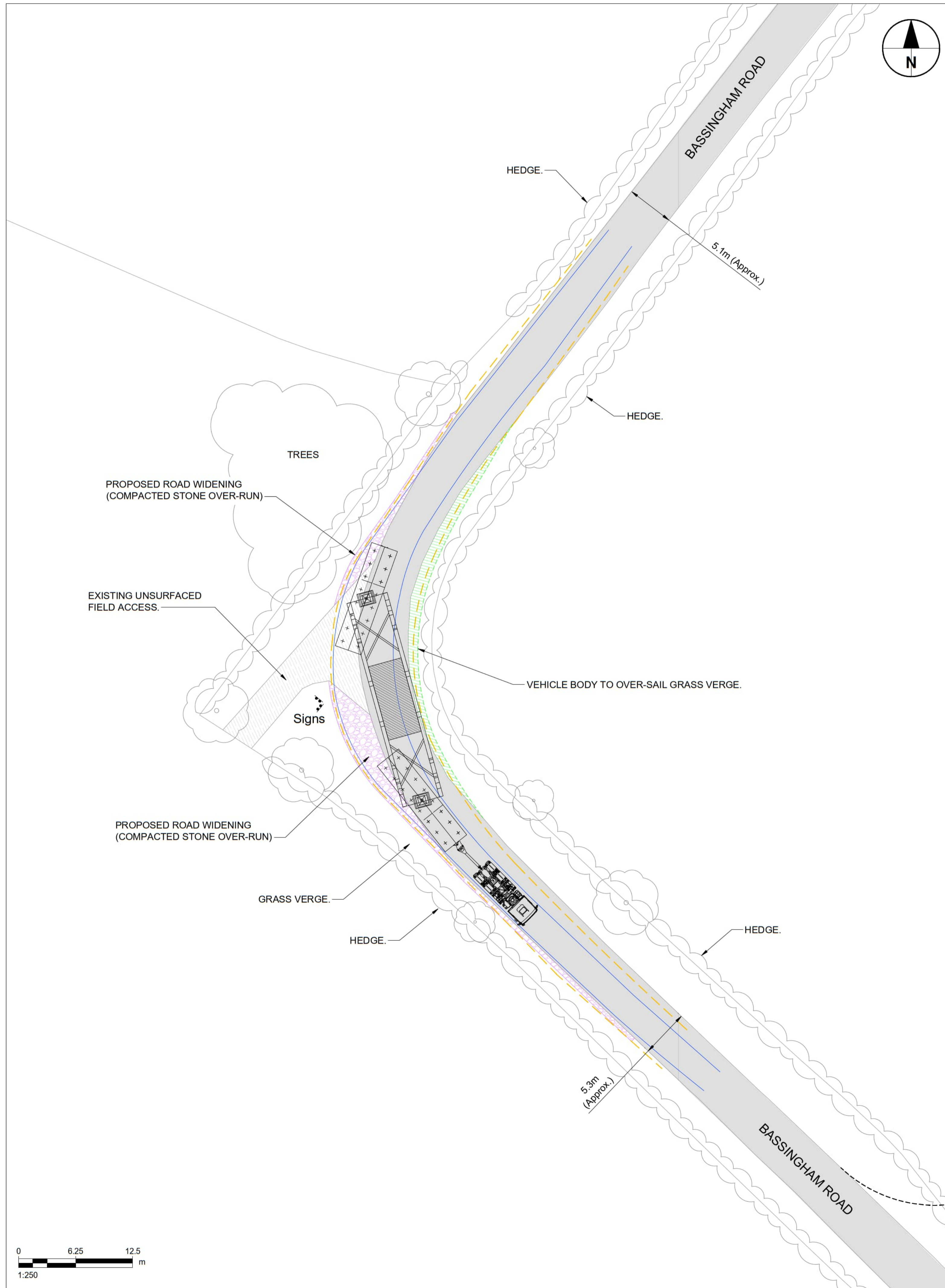

- NOTES:**
1. VEHICLE TRACKING SHOWN IS INDICATIVE ONLY, AND REPRESENTS APPROXIMATE VEHICLE SIZE / ARRANGEMENT ANTICIPATED FOR TRANSFORMER DELIVERY. SPECIFIC VEHICLE SIZE / ARRANGEMENT TO BE DETERMINED BY EQUIPMENT SUPPLIER AND HEAVY HAULAGE CONTRACTOR.
  2. DEFINITIVE VEHICLE TRACKING OF SPECIFIC DELIVERY VEHICLE REQUIRES TO BE CARRIED OUT BY THE HEAVY HAULAGE CONTRACTOR, TO ENSURE THE DESIRED MANOEUVRES ARE ACHIEVABLE, AND TO CONFIRM ANY REQUIRED ROAD WIDENING, TEMPORARY WORKS, etc.
  3. THIS DRAWING IS BASED ON ORDNANCE SURVEY MAPPING, AND AS SUCH IS INDICATIVE ONLY. ALL LINWORK, DIMENSIONS, STREET FURNITURE, etc. ARE APPROXIMATE ONLY.
  4. THIS DRAWING IS BASED ON THE ASSUMED AIL ROUTE TO SITE. FINAL ROUTE TO BE DETERMINED BY THE HEAVY HAULAGE CONTRACTOR.

INDICATIVE SITE ENTRANCE.  
 REFER DRAWING 60700987-ACM-XX-00-DR-CE-1009.

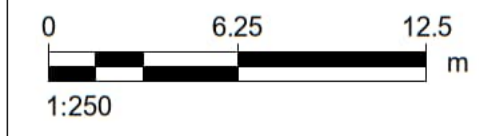

**Project**  
 Fosse Green Energy

**Client**  
 Fosse Green Energy Ltd

**Consultant**  
**Aecom**  
 2 City Walk  
 Leeds  
 LS11 9AR  
 United Kingdom  
 Fax +44 (0)113 391 6899  
 Tel +44 (0)113 391 6800  
 www.aecom.com

- Notes**
1. ALL DIMENSIONS IN METRES UNLESS STATED OTHERWISE.
  2. FOR OVERVIEW OF PROPOSED ABNORMAL LOAD ROUTE, REFER DRAWING 60700987-ACM-XX-00-DR-CE-1000.

- KEY**
- PROPOSED AIL ROUTE TO SITE
  - EXISTING CARRIAGEWAY
  - APPROXIMATE VEHICLE WHEEL TRACK
  - APPROXIMATE OVER-SAIL OF VEHICLE BODY
  - APPROXIMATE EXTENT OF OVER-SAIL AREA (AREA REQUIRES TO BE CLEAR OF ANY ABOVE-GROUND FEATURES)
  - APPROXIMATE EXTENT OF PROPOSED ROAD WIDENING (COMPACTED STONE OVER-RUN)

ISSUE/REVISION			
Rev	Date	Description	Dm/Chk/Apr
-	12.12.23	FIRST ISSUE	EP/CGY/MW

**Suitability Status**  
 S2 - Suitable For Information

**Project Number**  
 60700987

**Sheet Title**  
 ABNORMAL LOAD ROUTE TO SITE  
 VEHICLE TRACKING LOCATION 08  
 BASSINGHAM ROAD

**Sheet Number**  
 60700987-ACM-XX-00-DR-CE-1008

**Scale:** 1:250 @ A1      **Rev:** -

This drawing has been prepared for the use of AECOM's client. It may not be used, modified, reproduced or relied upon by third parties, except as required by law. AECOM accepts no responsibility, and denies any liability, whatsoever, to any party that uses or relies on this drawing without AECOM's express written consent. Do not scale this document. All measurements must be obtained from the stated dimensions.

